

MCS LRW

LoRaWAN® compact multi sensor

thermokon®

HOME OF SENSOR TECHNOLOGY



Datasheet

Subject to technical alteration
Issue date: 29.04.2024 • A140



» APPLICATION

LoRaWAN® compact multi sensor with temperature and humidity detection, state- and movement detection with luminosity measurement optional type dependent. The radio signal is transmitted by LoRaWAN® technology to the receiver.

» TYPES AVAILABLE

- MCS LRW State
- MCS LRW State Temp_rH
- MCS LRW Temp_rH
- MCS LRW Lum Temp_rH
- MCS LRW Occ Temp_rH
- MCS LRW Occ Lum Temp_rH
- MCS LRW Occ Lum State Temp_rH

» LAYOUT

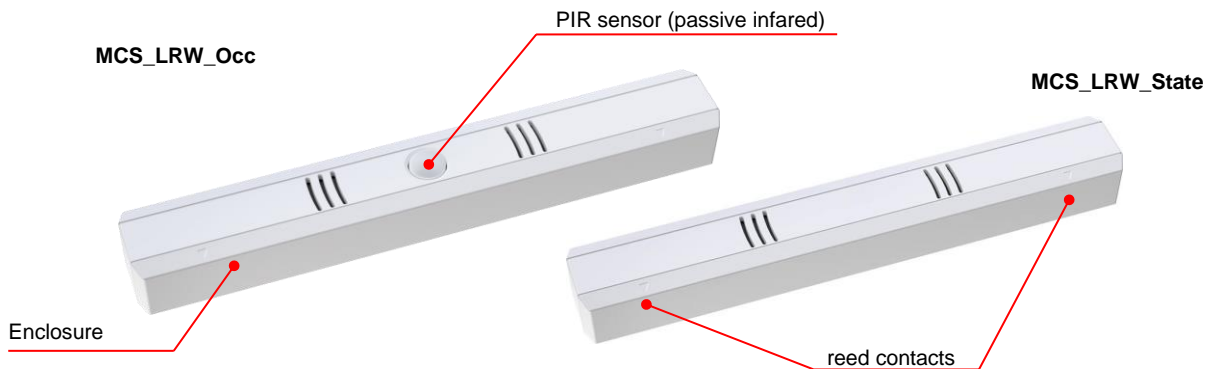

» SECURITY ADVICE – CAUTION



The installation and assembly of the device should only be performed by authorized personnel.

The product should only be used for the intended application. Unauthorised modifications are prohibited! The product must not be used in relation with any equipment that in case of a failure may threaten, directly or indirectly, human health or life or result in danger to human beings, animals or assets. Ensure all power is disconnected before installing. Do not connect to live/operating equipment.

Please comply with:

- Local laws, health & safety regulations, technical standards and regulations
- Condition of the device at the time of installation, to ensure safe installation
- This data sheet and installation manual

» PRODUCT TESTING AND CERTIFICATION



Declaration of conformity

The declaration of conformity of the products can be found on our website
<https://www.thermokon.de/direct/en-gb/categories/mcs>

» NOTES ON DISPOSAL



The crossed-out wheeled bin symbol indicates that the product or removable batteries must not be disposed of with household or commercial waste. Within the EU, you are legally obliged to dispose of the product separately and appropriately in accordance with the national laws of your country. Alternatively, please contact your supplier or Thermokon Sensortechnik GmbH. Further information can be found at: www.thermokon.com

» TECHNICAL DATA

Enclosure	PC V0, pure white
Protection	IP20 according to DIN EN 60529
Ambient condition	-20..+60 °C, max. 85% rH non-condensing
Mounting	surface-mounted flat on base using included adhesive pad or screws

Radio technology	LoRaWAN®
LoRaWAN version	1.0.4
Device class	Class A
Frequency	EU868 (863-870 MHz)
Max. transmission power	+14 dBm (25 mW)
Receiver sensitivity	-137 dBm
Antenna	internal send- / receiver antenna
LoRaWAN Features	Over The Air Activation (OTAA), Adaptive Data Rate (ADR)
Data transmission (configurabel)	Heartbeat interval (default: 1440 min), Measurement-interval (default: 1 min), hysteresis transmission behavior

Configuration	LRWapp, LoRaWAN® Downlink, uConfig
Power supply	1x AAA battery 1,5-3,6V (alkali or lithium)
Battery life	+/- 5 years (depending on device configuration, network setup, battery-type* and ambient conditions)

* 3,6V Lithium battery (compared to 1,5V alkaline) recommended to increase battery life

» MCS State

Measuring values	State
Sensor	2 reed-contacts + magnets

» MCS Temp_rH

Measuring values	Temperature, Humidity
Accuracy temperature	±0,4 K (typ. at 21 °C)
Accuracy humidity	±2% between 30..70% rH (typ. at 21 °C)

» MCS OCC

Measuring values	Movement
Detection range	Ø=5 m at approx. 2,5 m installation height (max. 5m)
Sensor	PIR (passive Infrared)

» MCS Lum



Measuring values	Light									
Measuring range light	0-65535 Lux									
Accuracy light* (Values in Lux)	±5% of value range									
	<table border="1"> <thead> <tr> <th colspan="3">Value range</th> </tr> </thead> <tbody> <tr> <td>0 – 200</td> <td>1.000 - 2.000</td> <td>10.000 – 20.000</td> </tr> <tr> <td>200 - 1.000</td> <td>2.000 - 10.000</td> <td>20.000 – 50.000</td> </tr> </tbody> </table>	Value range			0 – 200	1.000 - 2.000	10.000 – 20.000	200 - 1.000	2.000 - 10.000	20.000 – 50.000
Value range										
0 – 200	1.000 - 2.000	10.000 – 20.000								
200 - 1.000	2.000 - 10.000	20.000 – 50.000								

*Accuracy depends on used value range. Sensor uses value range depending on detected light.

» **COMMISSIONING**

After inserting a battery for power supply the device is ready for operation. Prior to installation ensure that the required area is covered and the radio reception is sufficient. The mounting can be done by using the included adhesive pad or screws.

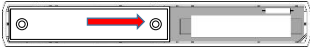
» **Device Opening**

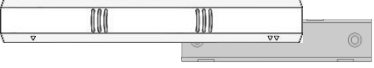
Bottom View	Top View
 <p>Push bottom cover laterally.</p>	 <p>Move device laterally to the left (observe arrow symbol orientation!)</p>
 <p>Remove cover</p>	 <p>Remove top section</p>

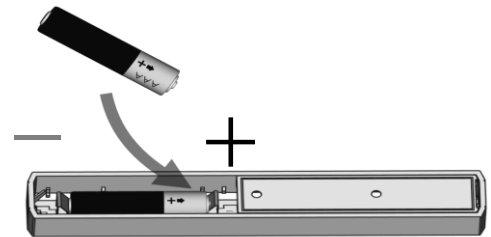

» **BATTERY INSTALLATION**

The MCS-LRW is permanently supplied by the installed AAA battery. Position the battery as shown in the picture. (included in scope of delivery)



» **CONFIGURATION**

The configuration is performed in powered state. The following options are available for configuring the device:

Device connection	Micro-USB cable	Bluetooth radio	LoRaWAN® downlink
			
Configurations-software	PC/Notebook with uConfig software	Smartphone/Tablet with LRWApp	LoRaWAN Infrastructure

The configuration app with the corresponding instructions can be downloaded from the Google Play Store or the Apple App Store.

» **ADVICE FOR BLUETOOTH CONFIGURATION**



Press the button to start Bluetooth communication. After pressing the button, a connection can be established via the app within approx. 20 seconds. This is indicated by a flashing LED.

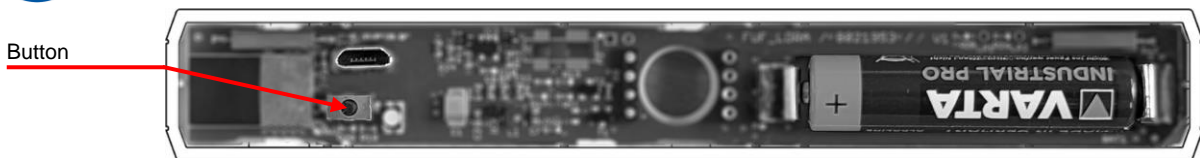

» **ADVICE FOR COMMISSIONING:**



The LoRaWAN credentials required for commissioning can be read out via the uConfig software or the LRWApp. On request, the LoRaWAN credentials can also be provided in digital form. For this purpose, please contact your respective contact person.

» INFORMATION ABOUT LORAWAN SPECIFICATION



The Thermokon LoRaWAN specification can be downloaded from our website.

» FUNCTIONAL DESCRIPTION MCS-STATE

Mount the lower part of housing with adhesive tape (already mounted) or optional with screws onto the frame. The window contact can be mounted horizontal, vertical or inclined.

Mount the magnet flat as shown next to the arrow marking.

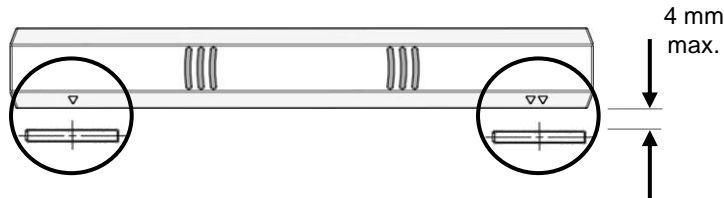

Observe the markings on the window contact!

» FUNCTIONAL DESCRIPTION MCS-OCC

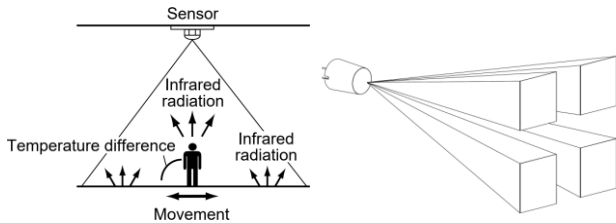

The sensor lens divides the detection area in 32 measurement areas. The sensor detects changes in infrared radiation that occur when an object* (or person) moves that has a different IR temperature than its surroundings

* Object properties:

Temperature difference (between object and environment)	> +4°C
Object-speed	> 1,0 m/s
Object-size	> 700x250 mm



The motion detector should not be mounted near disturbing heat sources (e.g. lamps, radiators, fans etc.) to avoid false alarms:
Fast temperature changes on the environment can trigger false alarms.

» DETECTION RANGE (MCS-OCC)

Detection range	
Detection distance*/ Installation height	5 m max.
Field of view horizontal	< 90° / 110°
Field of view vertical	< 90° / 110°
Detection zone	32

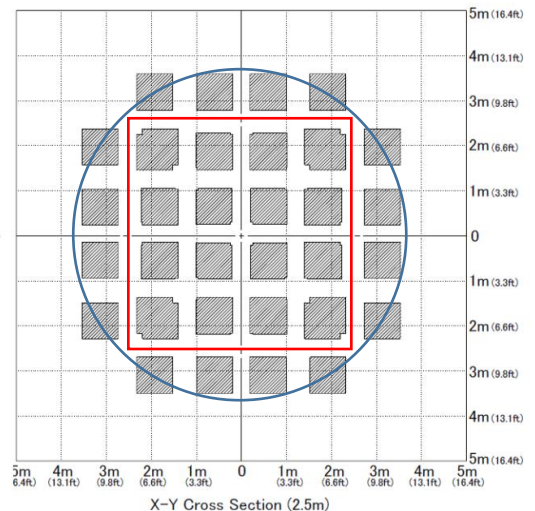
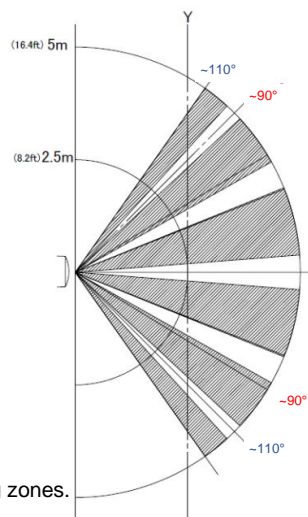

An installation height of 2,5 m results in a square detection zone of approx. 5 x 5 m, or a circular detection zone of approx. Ø 7 m divided in 32 measuring zones.

Formula: $\tan(\text{field of view}/2) \cdot \text{installation height} = \text{Radius detection range}$

* The specified ranges refer to average conditions at a certain mounting height and are approximate values.

Function test

A function test ensures that a movement is located in the optical detection area of the sensor. Walk through the detection area after integrating the device in a LoRaWAN® Network and check whether a radio telegram was send.

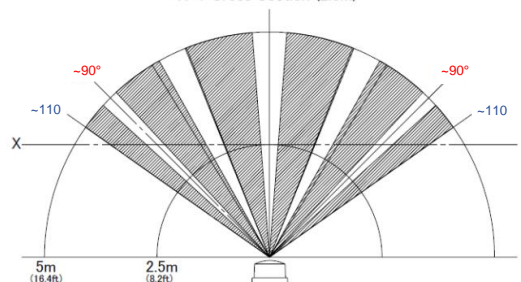

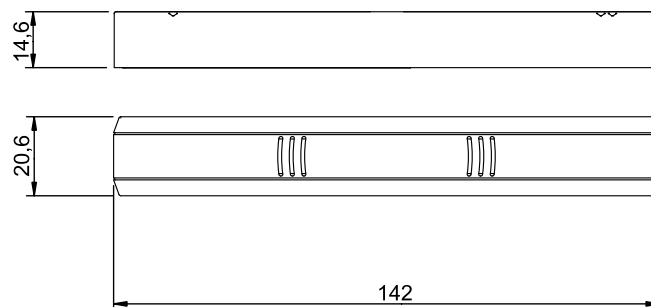
» DIMENSIONS (MM)**» ACCESSORIES (SCOPE OF DELIVERY)**

battery 1,5V AAA (Micro)

Item-No.: 739351

» ACCESSORIES (OPTIONAL)

battery 3,6V AAA Lithium (ER10450)

Item-No.: 794756