

Industrial Router Ultra Series

UR75

User Guide



Preface

Thanks for choosing Milesight UR75 industrial cellular router. The UR75 industrial cellular router delivers tenacious connection over network with full-featured design such as automated failover/failback, extended operating temperature, dual SIM cards, hardware watchdog, VPN, Fast Ethernet and beyond.

This guide describes how to configure and operate the UR75 industrial cellular router. You can refer to it for detailed functionality and router configuration.

Readers

This guide is mainly intended for the following users:

- Network Planners
- On-site technical support and maintenance personnel
- Network administrators responsible for network configuration and maintenance

© 2011-2022 Xiamen Milesight IoT Co., Ltd.

All rights reserved.

All information in this user guide is protected by copyright law. Whereby, no organization or individual shall copy or reproduce the whole or part of this user guide by any means without written authorization from Xiamen Milesight IoT Co., Ltd.

Related Documents

Document	Description
UR75 Datasheet	Datasheet for the UR75 industrial cellular router.
UR75 Quick Start Guide	Quick Installation guide for the UR75 industrial cellular router.

Declaration of Conformity

UR75 is in conformity with the essential requirements and other relevant provisions of the CE, FCC, and RoHS.



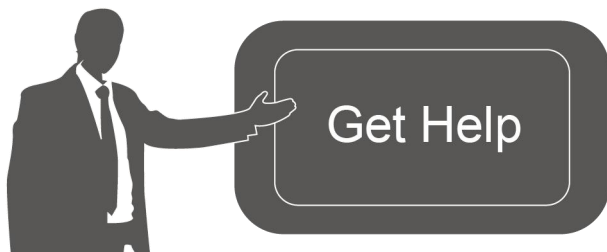

For assistance, please contact
Milesight technical support:
Email: iot.support@milesight.com
Tel: 86-592-5085280
Fax: 86-592-5023065
Address: Building C09, Software Park III,
Xiamen 361024, China

Revision History

Date	Doc Version	Description
July 29, 2020	V 1.0	Initial version
July 31, 2020	V 1.1	2 RS485 optional
Dec. 9, 2020	V 2.0	Layout replace
June 17, 2021	V 2.1	<ol style="list-style-type: none">1. Cellular and ping detection support IPv62. Add WAN connection type: DHCPv6 client, PPPoEv6, DS-Lite3. Add DHCPv6 Server feature4. Add Expert Option box in IPsec settings

Contents

Chapter 1 Product Introduction.....	8
1.1 Overview.....	8
1.2 Advantages.....	8
1.3 Specifications.....	9
1.4 Dimensions (mm).....	12
Chapter 2 Access to Web GUI.....	13
2.1 Wireless Access.....	13
2.2 Wired Access.....	13
Chapter 3 Web Configuration.....	17
3.1 Status.....	17
3.1.1 Overview.....	17
3.1.2 Cellular.....	18
3.1.3 Network.....	20
3.1.4 WLAN.....	21
3.1.5 VPN.....	22
3.1.6 Routing.....	23
3.1.7 Host List.....	24
3.1.8 GPS.....	24
3.2 Network.....	25
3.2.1 Interface.....	25
3.2.1.1 Link Failover.....	25
3.2.1.2 Cellular.....	27
3.2.1.3 Port.....	30
3.2.1.4 WAN.....	30
3.2.1.5 Bridge.....	36
3.2.1.6 WLAN.....	36
3.2.1.7 Switch.....	39
3.2.1.8 Loopback.....	39
3.2.2 DHCP.....	40
3.2.2.1 DHCP Server/DHCPv6 Server.....	40
3.2.2.2 DHCP Relay.....	42
3.2.3 Firewall.....	43
3.2.3.1 Security.....	43
3.2.3.2 ACL.....	44
3.2.3.3 Port Mapping.....	45
3.2.3.4 DMZ.....	46
3.2.3.5 MAC Binding.....	47
3.2.3.6 Custom Rules.....	47
3.2.3.7 SPI.....	48
3.2.4 QoS.....	49
3.2.5 VPN.....	50
3.2.5.1 DMVPN.....	50

3.2.5.2 IPsec Server.....	52
3.2.5.3 IPsec.....	56
3.2.5.4 GRE.....	58
3.2.5.5 L2TP.....	59
3.2.5.6 PPTP.....	61
3.2.5.7 OpenVPN Client.....	63
3.2.5.8 OpenVPN Server.....	65
3.2.5.9 Certifications.....	67
3.2.6 IP Passthrough.....	69
3.2.7 Routing.....	70
3.2.7.1 Static Routing.....	70
3.2.7.2 RIP.....	70
3.2.7.3 OSPF.....	73
3.2.7.4 Routing Filtering.....	79
3.2.8 VRRP.....	79
3.2.9 DDNS.....	81
3.3 System.....	83
3.3.1 General Settings.....	83
3.3.1.1 General.....	83
3.3.1.2 System Time.....	84
3.3.1.3 Email.....	86
3.3.1.4 Storage.....	87
3.3.2 Phone&SMS.....	88
3.3.2.1 Phone.....	88
3.3.2.2 SMS.....	89
3.3.3 User Management.....	90
3.3.3.1 Account.....	90
3.3.3.2 User Management.....	91
3.3.4 SNMP.....	92
3.3.4.1 SNMP.....	92
3.3.4.2 MIB View.....	93
3.3.4.3 VACM.....	93
3.3.4.4 Trap.....	94
3.3.4.5 MIB.....	95
3.3.5 AAA.....	95
3.3.5.1 Radius.....	95
3.3.5.2 TACACS+.....	96
3.3.5.3 LDAP.....	97
3.3.5.4 Authentication.....	98
3.3.6 Device Management.....	98
3.3.6.1 DeviceHub.....	98
3.3.6.2 Milesight VPN.....	99
3.3.7 Events.....	101
3.3.7.1 Events.....	101

3.3.7.2 Events Settings.....	101
3.4 Industrial Interface.....	103
3.4.1 I/O.....	104
3.4.1.1 DI.....	104
3.4.1.2 DO.....	105
3.4.2 Serial Port.....	105
3.4.3 Modbus Slave.....	109
3.4.3.1 Modbus TCP.....	109
3.4.3.2 Modbus RTU.....	110
3.4.3.3 Modbus RTU Over TCP.....	110
3.4.4 Modbus Master.....	111
3.4.4.1 Modbus Master.....	111
3.4.4.2 Channel.....	112
3.4.5 GPS.....	114
3.4.5.1 GPS.....	115
3.4.5.2 GPS IP Forwarding.....	115
3.4.5.3 GPS Serial Forwarding.....	116
3.5 Maintenance.....	117
3.5.1 Tools.....	117
3.5.1.1 Ping.....	117
3.5.1.2 Traceroute.....	118
3.5.1.3 Packet Analyzer.....	118
3.5.1.4 Qxdmlog.....	119
3.5.2 Debugger.....	119
3.5.2.1 Cellular Debugger.....	119
3.5.2.2 Firewall Debugger.....	120
3.5.3 Log.....	121
3.5.3.1 System Log.....	121
3.5.3.2 Log Download.....	122
3.5.3.3 Log Settings.....	123
3.5.4 Upgrade.....	124
3.5.5 Backup and Restore.....	124
3.5.6 Reboot.....	125
3.6 APP.....	126
3.6.1 Python.....	126
3.6.1.1 Python.....	127
3.6.1.2 App Manager Configuration.....	127
3.6.1.3 Python App.....	128
Chapter 4 Application Examples.....	129
4.1 Restore Factory Defaults.....	129
4.1.1 Via Web Interface.....	129
4.1.2 Via Hardware.....	130
4.2 Firmware Upgrade.....	130
4.3 Events Application Example.....	131

4.4 SNMP Application Example.....	132
4.5 Network Connection.....	135
4.5.1 Cellular Connection.....	135
4.5.2 Ethernet WAN Connection.....	137
4.6 Wi-Fi Application Example.....	139
4.6.1 AP Mode.....	139
4.6.2 Client Mode.....	140
4.7 VRRP Application Example.....	141
4.8 NAT Application Example.....	144
4.9 Access Control Application Example.....	144
4.10 QoS Application Example.....	146
4.11 DTU Application Example.....	147
4.12 PPTP Application Example.....	150

Chapter 1 Product Introduction

1.1 Overview

UR75 is an industrial cellular router with embedded intelligent software features that are designed for multifarious M2M/IoT applications. Upgraded to the latest cellular technology - 5G, the UR75 makes it possible to enjoy ultra-fast broadband access with 5G cellular network.

Adopting high-performance and low-power consumption industrial grade CPU and wireless module, the UR75 is capable of providing wire-speed network with low power consumption and ultra-small package to ensure the extremely safe and reliable connection to the wireless network.

Meanwhile, the UR75 also supports Gigabit Ethernet ports, serial port (RS232/RS485) and I/O (input/output), which enables you to scale up M2M application combining data and video in limited time and budget.

The UR75 is particularly ideal for smart grid, digital media installations, industrial automation, telemetry equipment, medical device, digital factory, finance, payment device, environment protection, water conservancy and so on.

For details of hardware and installation, please check UR75 Quick Start Guide.

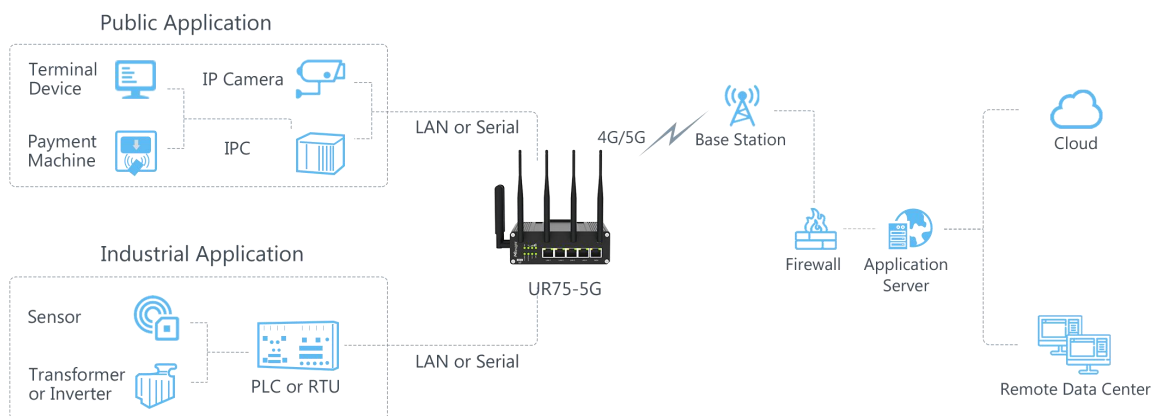

Figure 1-1

1.2 Advantages

Benefits

- Built-in Qualcomm quad-core CPU and big memory
- 4G LTE/5G NR(NSA/SA) network with dual SIM cards for backup between multiple carriers networking
- Gigabit Ethernet for data transmission
- Equipped with Ethernet, I/O, serial port, Wi-Fi, GPS for connecting diverse field assets
- Embedded Python SDK for second development
- Rugged enclosure, optimized for DIN rail or shelf mounting
- 3-year warranty included

Security & Reliability

- Automated failover/failback between Ethernet and Cellular (dual SIM)
- Enable unit with security frameworks like IPsec/OpenVPN/GRE/L2TP/PPTP/ DMVPN
- Embed hardware watchdog, automatically recovering from various failure, and ensuring highest level of availability
- Establish a secured mechanism on centralized authentication and authorization of device access by supporting AAA (TACACS+, Radius, LDAP, local authentication) and multiple levels of user authority

Easy Maintenance

- Milesight DeviceHub provides easy setup, mass configuration, and centralized management of remote devices
- The user-friendly web interface design and several upgrade options help administrator to manage the device as easy as pie
- Web GUI and CLI enable the admin to achieve simple management and quick configuration among a large quantity of devices
- Efficiently manage the remote routers on the existing platform through the industrial standard SNMP

Capabilities

- Link remote devices in an environment where communication technologies are constantly changing
- It can be continuously running in a broken or weak network environment, and the latest data can be synchronized to remote server after the network is restored
- Support rich protocols like SNMP, Modbus bridging, RIP, OSPF
- Support wide operating temperature ranging from -40°C to 70°C/-40°F to 158°F

1.3 Specifications

Hardware System	
CPU	Qualcomm Quad-core ARM Cortex A7, 716.8 MHz
Memory	8 GB Flash, 512 MB DDR3 RAM
Storage	1 × M.2 NVMe SSD interface
Ethernet	
Ports	5 × RJ-45 (PoE PSE Optional on LAN ports)
Physical Layer	10/100/1000 Base-T (IEEE 802.3)

Data Rate	10/100/1000 Mbps (auto-sensing)
Interface	Auto MDI/MDIX
Mode	Full or half duplex (auto-sensing)
Cellular Interfaces	
Connectors	UR75-5G: 4 × 50 Ω SMA (Center pin: SMA Female)
	UR75-4G: 2 × 50 Ω SMA (Center pin: SMA Female)
SIM Slots	2 (Mini SIM-2FF)
Wi-Fi Interface	
Connectors	2 × 50 Ω SMA (Center pin: RP-SMA Female)
Standards	IEEE 802.11 a/b/g/n/ac
Tx Power	2.4GHz: 26dBm(max)
	5GHz: 26.4dBm(max)
Rx Sensitivity	
2.4 GHz	802.11b: ≤ -92dBm@11Mbps
	802.11g: ≤ -78dBm@54Mbps
	802.11ac VHT20: ≤ -91dBm@MCS0
	802.11ac VHT20: ≤ -66dBm@MCS8
	802.11ac VHT40: ≤ -88.5dBm@MCS0
	802.11ac VHT40: ≤ -64dBm@MCS8
5 GHz	802.11a: ≤ -91dBm@6Mbps
	802.11a: ≤ -76dBm@54Mbps
	802.11ac VHT20: ≤ -90dBm@MCS0
	802.11ac VHT20: ≤ -68dBm@MCS8
	802.11ac VHT40: ≤ -87dBm@MCS0
	802.11ac VHT40: ≤ -65dBm@MCS9
	802.11ac VHT80: ≤ -84dBm@MCS0
	802.11ac VHT80: ≤ -60dBm@MCS9
Modes	AP and Client mode
Security	WPA/WPA2 authentication, WEP/TKIP/AES encryption
GPS¹	
Connectors ²	1 × 50 Ω SMA (Center PIN: SMA Female)
Technology	GPS/GLONASS/Beidou/Galileo/QZSS

¹ For 5G model, GPS is supported by default; for 4G model, GPS is optional;

² For 5G model, GPS antenna is combined with cellular antenna; for 4G model, GPS antenna is standalone.

Serial Interface

Ports	1 × RS232 + 1 × RS485 (2 × RS485 Optional)
-------	--

Connector	Terminal block
-----------	----------------

Baud Rate	300bps to 230400bps
-----------	---------------------

IO

Connector	Terminal block
-----------	----------------

Digital	1 × DI + 1 × DO
---------	-----------------

Software

Network Protocols	IPv4/IPv6, PPP, PPPoE, SNMP v1/v2c/v3, TCP, UDP, DHCP, RIPv1/v2, OSPF, DDNS, VRRP, HTTP, HTTPS, DNS, ARP, QoS, SNTP, Telnet, VLAN, SSH, etc.
-------------------	--

VPN Tunnel	DMVPN/IPsec/OpenVPN/PPTP/L2TP/GRE
------------	-----------------------------------

Access Authentication	CHAP/PAP/MS-CHAP/MS-CHAPV2
-----------------------	----------------------------

Firewall	ACL/DMZ/Port Mapping/MAC Binding/SPI/DoS&DDoS Protection /IP Passthrough
----------	--

Management	Web, CLI, SMS, On-demand dial up, DeviceHub
------------	---

AAA	Radius, TACACS+, LDAP, Local Authentication
-----	---

Multilevel Authority	Multiple levels of user authority
----------------------	-----------------------------------

Reliability	VRRP, WAN Failover, Dual SIM Backup
-------------	-------------------------------------

Serial Port	Transparent (TCP Client/Server, UDP), Modbus Gateway (Modbus RTU to Modbus TCP)
-------------	---

Power Supply and Consumption

Connector	2-pin with 5.08 mm terminal block
-----------	-----------------------------------

Input Voltage	9-48 VDC
---------------	----------

Power Consumption	< 7.9 W(non-PoE mode)
-------------------	-----------------------

Power Output	4 × 802.3 af/at PoE output
--------------	----------------------------

Physical Characteristics

Ingress Protection	IP30
--------------------	------

Housing	Metal
---------	-------

Dimensions	135 x 118 x 45 mm (5.31 x 4.65 x 1.77 in)
------------	---

Mounting	Desktop, wall or DIN rail mounting
----------	------------------------------------

Others

USB	1 × USB 2.0 (Reserved)
-----	------------------------

Reset Button	1 × RESET
--------------	-----------

LED Indicators	1 × POWER, 1 × SYSTEM, 1 × SIM, 1 × Wi-Fi, 1 × VPN, 3 × Signal strength
Built-in	Watchdog, Timer
Environmental	
Operating Temperature	-40°C to +70°C (-40°F to +158°F)
Temperature	Reduced cellular performance above 60°C
Storage Temperature	-40°C to +85°C (-40°F to +185°F)
Ethernet Isolation	1.5 kV RMS
Relative Humidity	0% to 95% (non-condensing) at 25°C/77°F

1.4 Dimensions (mm)

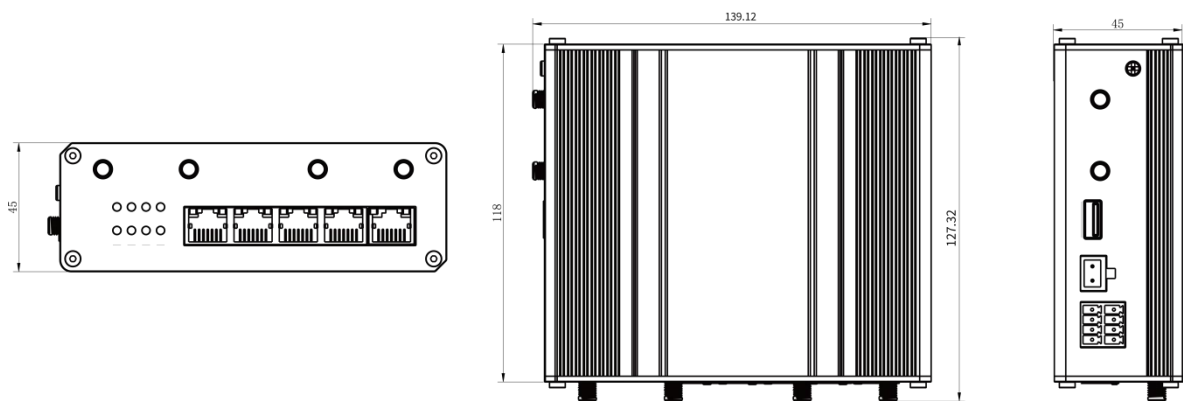

Figure 1-2

Chapter 2 Access to Web GUI

This chapter explains how to access to Web GUI of the UR75 router.

Username: **admin**

Password: **password**

IP Address: **192.168.1.1**

2.1 Wireless Access

1. Enable Wireless Network Connection on your computer and search for access point "**Router_*******" to connect it.
2. Open a Web browser on your PC (Chrome is recommended) and type in the IP address **192.168.1.1** to access the web GUI.
3. Enter the username and password, and click "Login".

English

Milesight

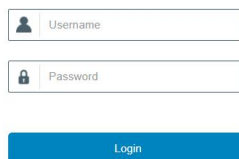

A login form with two input fields: 'Username' and 'Password'. Below the fields is a blue 'Login' button. The 'Password' field has a lock icon on the left.



If you enter the username or password incorrectly more than 5 times, the login page will be locked for 10 minutes.

4. When you login with the default username and password, you will be asked to modify the password. It's suggested that you change the password for the sake of security. Click "Cancel" button if you want to modify it later.

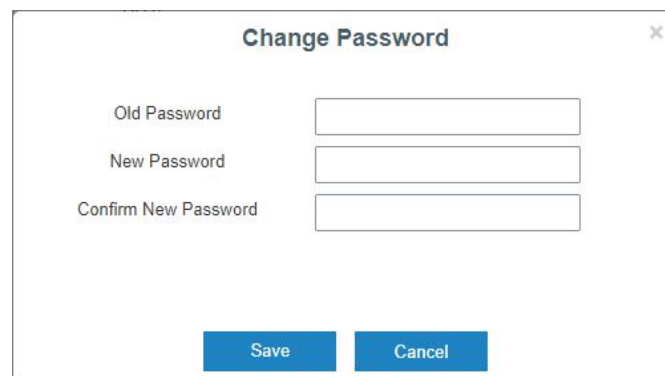

A dialog box titled 'Change Password' with a close button (X) in the top right corner. It contains three input fields: 'Old Password', 'New Password', and 'Confirm New Password'. At the bottom, there are two buttons: 'Save' and 'Cancel'.

5. After you login the Web GUI, you can view system information and perform configuration on the router.

The screenshot displays the Milesight Web GUI interface. The top navigation bar includes the Milesight logo, a user profile for 'admin', and a refresh icon. The main content area is divided into several sections:

- System Information:**
 - Model: UR75-500GL-G-P-W
 - Serial Number: 6223A5031136
 - Firmware Version: 76.2.0.2
 - Hardware Version: V1.1
- System Status:**
 - Local Time: 2021-10-27 10:42:53 Wednesday
 - Uptime: 50days, 18:23:02
 - CPU Load: 5%
 - RAM (Available/Capacity): 231MB/512MB(45.12%)
 - Flash (Available/Capacity): 2862MB/4096MB(69.87%)
- Cellular:**
 - Status: No SIM Card
 - Current SIM: SIM1
 - IPv4: 0.0.0.0/0
 - IPv6: -
 - Connection Duration: 0 days, 00:00:00
 - Data Usage Monthly: 0.0 MIB
- WAN:**
 - Status: Online
 - IPv4: 192.168.5.62/24
 - IPv6: fe80::26e1:24ff:fe1:3666/64
 - MAC: 24-e1-24-f1:36-66
 - Connection Duration: 50 days, 18:21:35

Buttons for 'Manual Refresh' and 'Refresh' are located at the bottom right of the main content area. A 'Help' sidebar is visible on the right side of the page.

2.2 Wired Access

Connect PC to LAN port of U735 router directly. The following steps are based on Windows 10 operating system for your reference.

1. Go to "Control Panel" → "Network and Internet" → "Network and Sharing Center", then click "Ethernet" (May have different names).

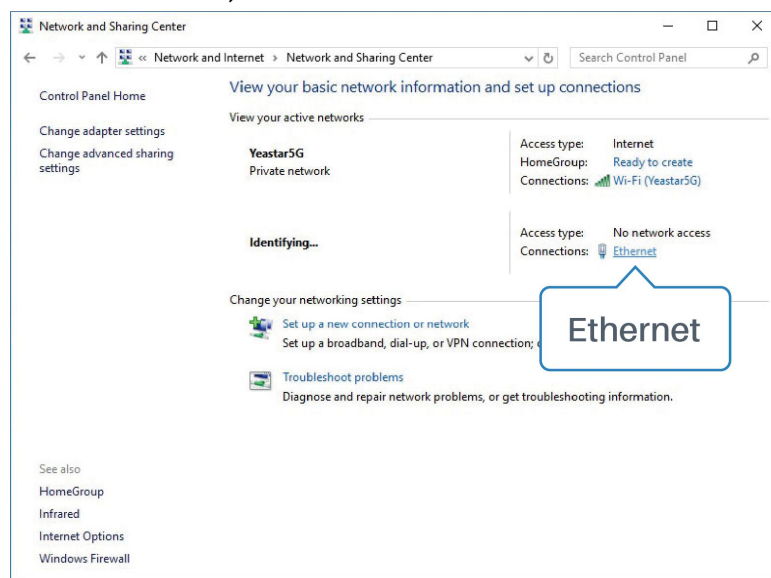

2. Go to "Properties" → "Internet Protocol Version 4(TCP/IPv4)", select "Obtain an IP address automatically" or "Use the following IP address", then assign a static IP manually within the same subnet of the device.

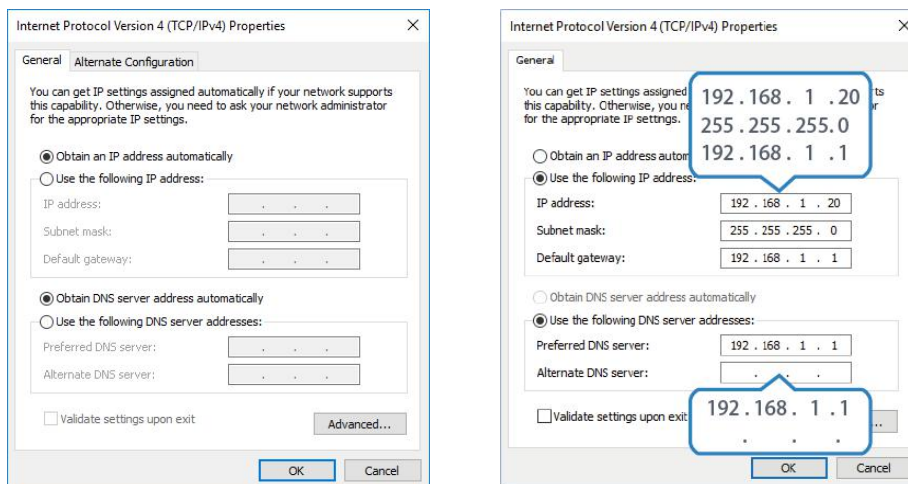

3. Open a Web browser on your PC (Chrome is recommended), type in the IP address 192.168.1.1, and press Enter on your keyboard.

4. Enter the username, password, and click "Login".

English

Milesight

! If you enter the username or password incorrectly more than 5 times, the login page will be locked for 10 minutes.

5. When you login with the default username and password, you will be asked to modify the password. It's suggested that you change the password for the sake of security. Click "Cancel" button if you want to modify it later.

Change Password

 Old Password

 New Password

 Confirm New Password

6. After you login the Web GUI, you can view system information and perform configuration on the

router.

The screenshot displays the Milesight IoT router management interface. At the top left is the Milesight logo. The top right shows a user profile for 'admin' and a refresh icon. Below the header is a navigation menu with tabs: Overview (selected), Cellular, Network, WLAN, VPN, Routing, Host List, and GPS. A left sidebar contains a menu with categories: Status, Network, System, Industrial, Maintenance, and APP. The main content area is divided into two columns: 'System Information' and 'System Status'. The 'System Information' column lists details such as Model (UR75-500GL-G-P-W), Serial Number (6223A5031136), Firmware Version (76.2.0.2), and Hardware Version (V1.1). The 'System Status' column shows Local Time (2021-10-27 10:42:53 Wednesday), Uptime (50 days, 18:23:02), CPU Load (5%), and RAM/Flash usage. Below these are 'Cellular' and 'WAN' sections. The 'Cellular' section shows 'No SIM Card' status and 'SIM1' as the current SIM. The 'WAN' section shows 'Link in use' status and various IP addresses (IPv4: 192.168.5.62/24, IPv6: fe80::26e1:24ff:fe11:3666/64) and MAC address (24-e1-24-f1:36-66). At the bottom right of the main content area are 'Manual Refresh' and 'Refresh' buttons. On the far right, a 'Help' sidebar is open, listing various system parameters like Model, Serial Number, Firmware Version, Hardware Version, Local Time, Uptime, CPU Load, and RAM (Available/Capacity) with brief descriptions for each.

Chapter 3 Web Configuration

3.1 Status

3.1.1 Overview

You can view the system information of the router on this page.

Overview	Cellular	Network	WLAN	VPN	Routing	Host List	GPS
System Information				System Status			
Model		UR75-500GL-G-W				Local Time	2021-06-17 06:31:02 Thursday
Serial Number		6223A3075105				Uptime	01:49:59
Firmware Version		76.1.0.30				CPU Load	1%
Hardware Version		V1.1				RAM (Available/Capacity)	208MB/512MB(40.63%)
						Flash (Available/Capacity)	2866MB/4096MB(69.97%)
Cellular ● Link in use				WAN ● Link in use			
Status		Ready, 5G NR, 				Status	Online
Current SIM		SIM2				IPv4	192.168.22.108/24
IPv4		0.0.0.0/0				IPv6	fe80::26e1:24ff:fe0:db3e/64
IPv6		2408:844b:1a20:fc0:82:ed73:51c4:4358/64				MAC	24:e1:24:f0:db:3e
Connection Duration		0 days, 00:15:13				Connection Duration	0 days, 01:48:40
Data Usage Monthly		0.0 MIB					
WLAN-2.4G				WLAN-5G			
Status		Running				Status	Running
Mode		AP				Mode	AP
SSID		charlestest1				SSID	charlestest2
Connected Clients		0				Connected Clients	0
LAN							
IPv4		192.168.1.1/24					
IPv6		2001::1/64					
Connected Devices		0					

Figure 3-1-1-1

System Information	
Item	Description
Model	Show the model name of router.
Serial Number	Show the serial number of router.
Firmware Version	Show the currently firmware version of router.
Hardware Version	Show the currently hardware version of router.

Table 3-1-1-1 System Information

System Status	
Item	Description
Local Time	Show the currently local time of system.
Uptime	Show the information on how long the router has been running.
CPU Load	Show the current CPU utilization of the router.
RAM (Available/Capacity)	Show the RAM capacity and the available RAM memory.

Flash (Available/Capacity)	Show the Flash capacity and the available Flash memory.
----------------------------	---

Table 3-1-1-2 System Status

Cellular	
Item	Description
Status	Show the real-time status of the currently SIM card.
Current SIM	Show the SIM card currently used for the data connection.
IPv4/IPv6	Show the IPv4/IPv6 address obtained from the mobile carrier.
Connection Duration	Show the connection duration of the currently SIM card.
Data Usage Monthly	Show the monthly data usage statistics of currently used SIM card.

Table 3-1-1-3 Cellular Status

WAN	
Item	Description
Status	Show the currently status of WAN port of.
IPv4/IPv6	The IPv4/IPv6 address configured WAN port.
MAC	The MAC address of the Ethernet port.
Connection Duration	Show the connection duration of the WAN port.

Table 3-1-1-4 WAN Status

WLAN	
Item	Description
Status	Show the currently status of WLAN.
IP	Show the WLAN mode (AP or client).
SSID	Show the SSID of the WLAN AP or client.
Connected Clients	Show the amount of connected devices when mode is AP.

Table 3-1-1-5 WLAN Status

LAN	
Item	Description
IPv4/IPv6	Show the IPv4/IPv6 address of the LAN port.
Connected Devices	Number of devices that connected to the router's LAN.

Table 3-1-1-6 LAN Status

3.1.2 Cellular

You can view the cellular network status of router on this page.

Overview	Cellular	Network	WLAN	VPN	Routing	Host List	GPS
Modem		Network					
Status	Ready	Status	Connected				
Model	RM500Q-GL	IPv4 Address	0.0.0.0/0				
Version	RM500QGLABR11A02M4G	IPv4 Gateway	0.0.0.0				
Current SIM	SIM2	IPv4 DNS	0.0.0.0				
Signal Level	99asu (85dBm)	IPv6 Address	2408:844b:1a20:fc0:82:ed73:51c4:4358/64				
Register Status	Registered (Home network)	IPv6 Gateway	2408:844b:1a20:fc0:1d0a:9a67:4a3:3b5a				
IMEI	863305040133802	IPv6 DNS	2408:8899:0:0:0:0:8				
IMSI	460013932029950	Connection Duration	0 days, 00:31:23				
ICCID	89860118903900166823	Data Usage Monthly					
ISP	CHN-UNICOM	SIM-1	RX: 0.0 MIB TX: 0.0 MIB ALL: 0.0 MIB				
Network Type	5G NR	SIM-2	RX: 0.0 MIB TX: 0.0 MIB ALL: 0.0 MIB				
PLMN ID	46001						
LAC	5E3803						
Cell ID	0						
CQI	0						
DL Bandwidth	200 MHz						
UL Bandwidth	1.4 MHz						
SINR	8						
PCI	795						
RSRP	-82dBm						
RSRQ	-11dB						

Figure 3-1-2-1

Modem Information	
Item	Description
Status	Show corresponding detection status of module and SIM card.
Model	Show the model name of cellular module.
Current SIM	Show the current SIM card used.
Signal Level	Show the cellular signal level.
Register Status	Show the registration status of SIM card.
IMEI	Show the IMEI of the module.
IMSI	Show IMSI of the SIM card.
ICCID	Show ICCID of the SIM card.
ISP	Show the network provider which the SIM card registers on.
Network Type	Show the connected network type, such as LTE, 3G, etc.
PLMN ID	Show the current PLMN ID, including MCC, MNC, LAC and Cell ID.
LAC	Show the location area code of the SIM card.
Cell ID	Show the Cell ID of the SIM card location.
CQI	Show the Channel Quality Indicator of the cellular network.
DL Bandwidth	Show the DL bandwidth of the cellular network.
UL Bandwidth	Show the UL bandwidth of the cellular network.
SINR	Show the Signal Interference + Noise Ratio of the cellular network.
PCI	Show the physical-layer cell identity of the cellular network.
RSRP	Show the Reference Signal Received Power of the cellular network.
RSRQ	Show the Reference Quality Received Power of the cellular network.

ECGI	Show the E-UTRAN Cell Global Identifier of the cellular network.
EARFCN	Show the E-UTRA Absolute Radio Frequency Channel Number.
ENODEB ID	Show the eNodeB ID of the cellular network.

Table 3-1-2-1 Modem Information

Network	
Item	Description
Status	Show the connection status of cellular network.
IPv4/IPv6 Address	Show the IPv4/IPv6 address and netmask of cellular network.
IPv4/IPv6 Gateway	Show the IPv4/IPv6 gateway and netmask of cellular network.
IPv4/IPv6 DNS	Show the DNS of cellular network.
Connection Duration	Show information on how long the cellular network has been connected.

Table 3-1-2-2 Network Status

Data Usage Monthly	
Item	Description
SIM-1	Show the monthly data usage statistics of SIM-1.
SIM-2	Show the monthly data usage statistics of SIM-2.

Table 3-1-2-3 Data Usage Information

3.1.3 Network

On this page you can check the WAN and LAN status of the router.

WAN-IPv4							
Port	Status	Type	IPv4	Gateway	DNS	Connection Duration	
WAN	up	Static	192.168.23.169/24	192.168.23.1	114.114.114.11 4	3days,23h 46m 47s	

WAN-IPv6							
Port	Status	Type	IPv6	Gateway	DNS	Connection Duration	
WAN	up	Static	fe80::26e1:24ff:fe11:359e/64	-	-	3days,23h 46m 47s	

Figure 3-1-3-1

WAN Status	
Item	Description
Port	Show the name of WAN port.
Status	Show the status of WAN port. "up" refers to a status that WAN is enabled and Ethernet cable is connected. "down" means Ethernet cable is disconnected or WAN function is disabled.
Type	Show the dial-up connection type of WAN port.
IPv4/IPv6	Show the IPv4 address with netmask or IPv6 address with prefix-length of WAN port.
Netmask	Show the IPv4 netmask of WAN port.
Prefix-length	Show the IPv6 Prefix-length of WAN port.

Gateway	Show the gateway of WAN port.
DNS	Show the DNS of WAN port.
Connection Duration	Show the information on how long the Ethernet cable has been connected on WAN port when WAN function is enabled. Once WAN function is disabled or Ethernet connection is disconnected, the duration will stop.

Table 3-1-3-1 WAN Status

Bridge				
Name	STP	IPv4	IPv6	Members
Bridge0	Enabled	192.168.1.1/24	2004::1/64	eth1,WLAN-2.4G,WLAN-5G

Figure 3-1-3-2

Bridge	
Item	Description
Name	Show the name of the bridge interface.
STP	Show if STP is enabled.
IPv4/IPv6	Show the IPv4/IPv6 address and netmask of the bridge interface.
Members	Show the members of the bridge interface.

Table 3-1-3-2 Bridge Status

3.1.4 WLAN

You can check Wi-Fi status on this page, including the information of access point and client.

WLAN Status					
Name	Status	Type	SSID	IPv4 Address	IPv6 Address
WLAN-2.4G	Disconnected	Client	Gateway_F0DD63	-	-
WLAN-5G	Running	AP	charlestest2	192.168.1.1/24	-

Associated Stations				
SSID	MAC Address	IPv4 Address	IPv6 Address	Connection Duration

Figure 3-1-4-1

WLAN Status	
Item	Description
WLAN Status	
Name	Show the name of the Wi-Fi interface .
Status	Show the status of the Wi-Fi interface.
Type	Show the Wi-Fi interface type (AP or client).
SSID	Show the SSID of the router when the interface type is AP. Show the SSID of AP which the router connected to when the interface type is Client.
IPv4/IPv6 Address	Show the IPv4/IPv6 address and netmask of the router when the interface type is AP. Show the IPv4/IPv6 address and netmask of AP which the router connected to when the

	interface type is Client.
Associated Stations	
SSID	Show the SSID of the router when the interface type is AP. Show the SSID of AP which the router connected to when the interface type is Client.
MAC Address	Show the MAC address of the client which connected to the router when the interface type is AP. Show the MAC address of the AP which the router connected to when the interface type is Client.
IPv4/IPv6 Address	Show the IPv4/IPv6 address of the client which connected to the router when the interface type is AP. Show the IPv4/IPv6 address of the AP which the router connected to when the interface type is Client.
Connection Duration	Show the connection duration between client device and router when the interface type is AP. Show the connection duration between router and the AP when the interface type is Client.

Table 3-1-4-1 WLAN Status

3.1.5 VPN

You can check VPN status on this page, including PPTP, L2TP, IPsec, OpenVPN and DMVPN.

Overview	Cellular	Network	WLAN	VPN	Routing	Host List
Clients						
Name	Status	Local IP	Remote IP			
Server						
Name	Status					
OpenVPN Server	Disabled					
Ipsec Server	Disabled					
Connected List						
Server Type	Client IP	Duration				

Figure 3-1-5-1

VPN Status	
Item	Description
Clients	
Name	Show the name of the enabled VPN clients.

Status	Show the status of client. "Connected" refers to a status that client is connected to the server. "Disconnected" means client is disconnected to the server.
Local IP	Show the local IP address of the tunnel.
Remote IP	Show the real remote IP address of the tunnel.
Server	
Name	Show the name of the enabled VPN Server.
Status	Show the status of Server.
Connected List	
Server Type	Show the type of the server.
Client IP	Show the IP address of the client which connected to the server.
Duration	Show the information about how long the client has been connected to this server when the server is enabled. Once the server is disabled or connection is disconnected, the duration will stop counting.

Table 3-1-5-1 VPN Status

3.1.6 Routing

You can check routing status on this page, including the routing table and ARP cache.

Overview	Cellular	Network	WLAN	VPN	Routing	Host List	GPS
Routing Table							
Destination	Netmask/Prefix Length	Gateway	Interface	Metric			
0.0.0.0	0.0.0.0	192.168.22.1	WAN	1			
127.0.0.0	255.0.0.0	-	Loopback	-			
192.168.1.0	255.255.255.0	-	Bridge0	-			
192.168.22.0	255.255.255.0	-	WAN	-			
::	0	2408:844b:1a20:fc0:1d0a:9a67:4a3:3b 5a	Cellular 0	-			
::1	128	-	Loopback	-			
2001:4860:4860:8888	128	2408:844b:1a20:fc0:1d0a:9a67:4a3:3b 5a	Cellular 0	1			
2004::	64	-	Bridge0	-			
2400:3200::1	128	2408:844b:1a20:fc0:1d0a:9a67:4a3:3b 5a	Cellular 0	1			
2408:844b:1a20:fc0::	64	-	Cellular 0	-			
ARP Cache							
IP	MAC	Interface					
192.168.1.113	c8:5b:76:b2:56:1f	Bridge0					
192.168.22.127	24:e1:24:10:47:e1	WAN					
192.168.22.1	5c:dd:70:6c:46:3d	WAN					
192.168.22.6	f4:b5:49:f1:1b:1f	WAN					
192.168.23.77	24:4b:fe:8d:95:ab	WAN					
							Manual Refresh

Figure 3-1-6-1

Item	Description
Routing Table	
Destination	Show the IP address of destination host or destination network.
Netmask/Prefix Length	Show the netmask or prefix length of destination host or destination network.
Gateway	Show the IP address of the gateway.
Interface	Show the outbound interface of the route.
Metric	Show the metric of the route.
ARP Cache	
IP	Show the IP address of ARP pool.
MAC	Show the IP address's corresponding MAC address.
Interface	Show the binding interface of ARP.

Table 3-1-6-1 Routing Information

3.1.7 Host List

You can view the host information on this page.

Figure 3-1-7-1

Host List	
Item	Description
DHCP Leases	
IP Address	Show IP address of DHCP client
MAC/DUID	Show MAC address of DHCPv4 client or DUID of DHCPv6 client.
Lease Time Remaining	Show the remaining lease time of DHCP client.
MAC Binding	
IP	Show the IP address set in the Static IP list of DHCP service.
MAC/DUID	Show the MAC address or DUID set in the Static IP list of DHCP service.

Table 3-1-7-1 Host List Description

3.1.8 GPS

When GPS function is enabled and the GPS information is obtained successfully, you can view the latest GPS information including GPS Time, Latitude, Longitude and Speed on this page.

GPS Status	
Status	Weak Signal
Time for Locating	-
Satellites In Use	-
Satellites In View	-
Latitude	-
Longitude	-
Altitude	-
Speed	-

Figure 3-1-8-1

GPS Status	
Item	Description
Status	Show the status of GPS.
Time for Locating	Show the time for locating.
Satellites In Use	Show the quantity of satellites in use.
Satellites In View	Show the quantity of satellites in view.
Latitude	Show the Latitude of the location.
Longitude	Show the Longitude of the location.
Altitude	Show the Altitude of the location.
Speed	Show the speed of movement.

Table 3-1-8-1 GPS Status Description

3.2 Network

3.2.1 Interface

3.2.1.1 Link Failover

This section describes how to configure link failover strategies, their priority and the ping settings, each rule owns its own ping rules by default. Router will follow the priority to choose the next available interface to access the internet, make sure you have enable the full interface that you need to use here. If priority 1 can only use IPv4, UR75 will select a second link which IPv6 works as main IPv6 link and vice versa.

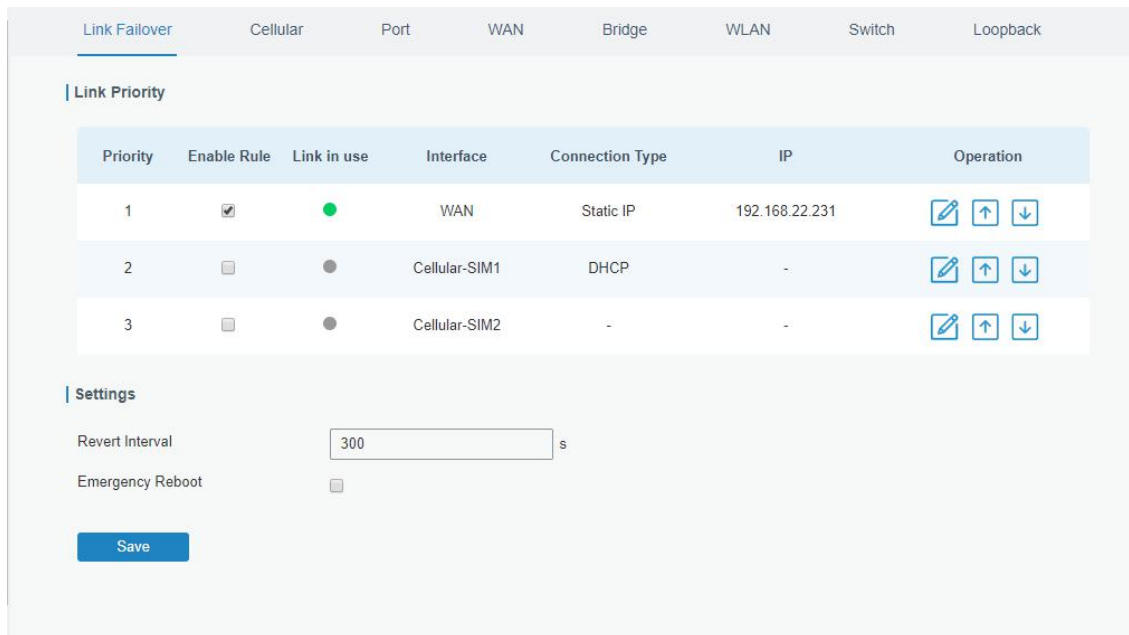

Figure 3-2-1-1

Link Failover	
Item	Description
Link Priority	
Priority	Display the priority of each interface, you can modify it by the operation's up and down button.
Enable Rule	If enabled, the router will choose this interface into its switching rule. For the Cellular interface, if it's not enabled here, the interface will be disabled as well.
Link In Use	Mark whether this interface is in use with Green color
Interface	Display the name of the interface.
Connection type	Display how to obtain the IP address in this interface, like static IP or DHCP.
IP	Display the IP address of the interface.
Operation	You can change the priority of the rules and configure the ping detection rules here.
Settings	
Revert Interval	Specify the number of seconds to waiting for switching to the link with higher priority, 0 means disable the function.
Emergency Reboot	Enable to reboot the device if no link is available.

Table 3-2-1-1 Link Failover Parameters

Ping Detection

Enable

IPv4 Primary Server

IPv4 Secondary Server

IPv6 Primary Server

IPv6 Secondary Server

Interval s

Retry Interval s

Timeout s

Max Ping Retries

OK Cancel

Figure 3-2-1-2

Ping Detection	
Item	Description
Enable	If enabled, the router will periodically detect the connection status of the link.
IPv4/IPv6 Primary Server	The router will send ICMP packet to the IPv4/IPv6 address or hostname to determine whether the Internet connection is still available or not.
IPv4/IPv6 Secondary Server	The router will try to ping the secondary server if primary server is not available.
Interval	Time interval (in seconds) between two Pings.
Retry Interval	Set the ping retry interval. When ping failed, the router will ping again in every retry interval.
Timeout	The maximum amount of time the router will wait for a response to a ping request. If it does not receive a response for the amount of time defined in this field, the ping request will be considered to have failed.
Max Ping Retries	The retry times of the router sending ping request until determining that the connection has failed.

Table 3-2-1-2 Ping Detection Parameters

3.2.1.2 Cellular

This section explains how to set the related parameters for cellular network. UR75 cellular router has two cellular interfaces, namely SIM1 and SIM2. Only one cellular interface is active at one time. If both cellular interfaces are enabled, it will follow the priority rule configured in “Link Failover” page.

	Link Failover	Cellular	Port	WAN	Bridge	WLAN	Switch	Loopback
Cellular Settings								
	SIM1				SIM2			
Protocol Type	IPv4				IPv4			
APN								
Username								
Password								
PIN Code								
Access Number								
Authentication Type	Auto				Auto			
Network Type	Auto				Auto			
SMS Center								
Enable NAT	<input checked="" type="checkbox"/>				<input checked="" type="checkbox"/>			
Roaming	<input checked="" type="checkbox"/>				<input checked="" type="checkbox"/>			
Data Limit	0 MB				0 MB			
Billing Day	Day 1 of The Month				Day 1 of The Month			
Connection Setting								
Connection Mode	Always Online							
Re-dial Interval(s)	5							

Figure 3-2-1-3

Cellular Settings	
Item	Description
Protocol	Select from "IPv4", "IPv6" and "IPv4/IPv6".
APN	Enter the Access Point Name for cellular dial-up connection provided by local ISP.
Username	Enter the username for cellular dial-up connection provided by local ISP.
Password	Enter the password for cellular dial-up connection provided by local ISP.
PIN Code	Enter a 4-8 characters PIN code to unlock the SIM.
Access Number	Enter the dial-up center NO. For cellular dial-up connection provided by local ISP.
Authentication Type	Select from "Auto", "PAP", "CHAP", "MS-CHAP", and "MS-CHAPv2".
Network Type	Select from "Auto", "5G NSA", "5G SA", "4G Only" and "3G Only". Auto: connect to the network with the strongest signal automatically. 4G Only: connect to 4G network only. And so on.

SMS Center	Enter the local SMS center number for storing, forwarding, converting and delivering SMS message.
Enable NAT	Enable or disable NAT function.
Roaming	Enable or disable roaming.
Data Limit	When you reach the specified data usage limit, the data connection of currently used SIM card will be disabled. 0 means disable the function.
Billing Day	Choose the billing day of the SIM card, the router will reset the data used to 0.

Table 3-2-1-3 Cellular Parameters

Figure 3-2-1-4

Connection Setting	
Item	Description
Connection Mode	Select from "Always Online" and "Connect on Demand".
Re-dial Interval(s)	Set the interval to dial into ISP when it lost connection, the default value is 5s.
Max Idle Times	Set the maximum duration of router when current link is under idle status. Range: 10-3600
Triggered by Call	The router will switch from offline mode to cellular network mode automatically when it receives a call from the specific phone number.
Call Group	Select a call group for call trigger. Go to "System > Phone&SMS > Phone" to set up phone group.
Triggered by SMS	The router will switch from offline mode to cellular network mode automatically when it receives a specific SMS from the specific mobile phone.
SMS Group	Select an SMS group for trigger. Go to "System > Phone&SMS > SMS" to set up SMS group.
SMS Text	Fill in the SMS content for triggering.
Triggered by IO	The router will switch from offline mode to cellular network mode

automatically when the DI status is changed. Go to "Industrial > I/O > DI" to configure trigger condition.

Table 3-2-1-4 Cellular Parameters

Related Topics

[Cellular Network Connection](#)

[Phone Group](#)

[DI Setting](#)

3.2.1.3 Port

This section describes how to configure the Ethernet port parameters.

UR75 cellular router supports 5 Gigabit Ethernet ports.

Port	Status	Property	Speed	Duplex
LAN1	up	lan	auto	auto
LAN2	up	lan	auto	auto
LAN3	up	lan	auto	auto
LAN4	up	lan	auto	auto
WAN	up	wan	auto	auto

Figure 3-2-1-5

Port Setting	
Item	Description
Port	Users can define the Ethernet ports according to their needs.
Status	Set the status of Ethernet port; select "up" to enable and "down" to disable.
Property	Show the Ethernet port's type, as a WAN port or a LAN port.
Speed	Ethernet port speed is fixed as "auto".
Duplex	Ethernet port mode is fixed as "auto".

Table 3-2-1-5 Port Parameters

3.2.1.4 WAN

WAN port can be connected with Ethernet cable to get Internet access. It supports 3 connection types.

- **Static IP:** configure IP address, netmask and gateway for Ethernet WAN interface.
- **DHCP Client:** configure Ethernet WAN interface as DHCP Client to obtain IPv4 address automatically.
- **PPPoE:** configure Ethernet WAN interface as PPPoE Client.
- **DHCPv6 Client:** configure Ethernet WAN interface as DHCP Client to obtain IPv6 address automatically.

- **PPPoE v6**: configure Ethernet WAN interface as PPPoEv6 Client.
- **Dual-Stack Lite**: use IPv4-in-IPv6 tunneling to send terminal device's IPv4 packet through a tunnel on the IPv6 access network to the ISP.

The screenshot shows the WAN Settings configuration page for WAN_1. The page is divided into tabs: Link Failover, Cellular, Port, WAN (selected), and Bridge. The WAN Settings section is expanded to show the configuration for WAN_1. The settings are as follows:

Setting	Value
Enable	<input checked="" type="checkbox"/>
Port	WAN
Connection Type	Static IP
IPv4 Address	192.168.22.108
Netmask	255.255.255.0
IPv4 Gateway	192.168.22.1
IPv6 Address	fe80::26e1:24ff:fe0:db3e
Prefix Length	64
IPv6 Gateway	
MTU	1500
IPv4 Primary DNS	114.114.114.114
IPv4 Secondary DNS	8.8.8.8
IPv6 Primary DNS	2001:4860:4860::8888
IPv6 Secondary DNS	
Enable NAT	<input checked="" type="checkbox"/>

Figure 3-2-1-6

WAN Basic Setting		
Item	Description	Default
Enable	Enable WAN function.	Enable
Port	The port that is currently set as WAN port.	WAN
Connection Type	Select from "Static IP", "DHCP Client", "DHCPv6 Client", "PPPoE", "DHCPv6 Client", "PPPoEv6", and "Dual-Stack Lite".	Static IP
MTU	Set the maximum transmission unit.	1500
IPv4 Primary DNS Server	Set the primary IPv4 DNS server.	114.114.114.114
IPv4 Secondary DNS Server	Set the secondary IPv4 DNS server.	8.8.8.8
IPv6 Primary	Set the primary IPv6 DNS server.	2001:4860:4

DNS Server		860:8888
IPv6 Secondary DNS Server	Set the secondary IPv6 DNS server.	--
Enable NAT	Enable or disable NAT function. When enabled, a private IP can be translated to a public IP.	Enable

Table 3-2-1-6 WAN Parameters

1. Static IP Configuration

If the external network assigns a fixed IP for the WAN interface, user can select "Static IP" mode.

Figure 3-2-1-7

Static IP		
Item	Description	Default
IPv4 Address	Set the IPv4 address of the WAN port.	192.168.0.1
Netmask	Set the Netmask for WAN port.	255.255.255.0
IPv4 Gateway	Set the gateway for WAN port's IPv4 address.	192.168.0.2
IPv6 Address	Set the IPv6 address which can access Internet.	Generated from Mac address
Prefix-length	Set the IPv6 prefix length to identify how many bits of a Global Unicast IPv6 address are there in network part. For example, in 2001:0DB8:0000:000b::/64, the number 64 is used to identify that the first 64 bits are in network part.	64
IPv6	Set the gateway for WAN port's IPv6 address.	--

Gateway	E.g.2001:DB8:ACAD:4::2.	
Multiple IP Address	Set the multiple IP addresses for WAN port.	Null

Table 3-2-1-7 Static Parameters

2. DHCP Client/DHCPv6 Client

If the external network has DHCP server enabled and has assigned IP addresses to the Ethernet WAN interface, user can select "DHCP client" mode to obtain IP address automatically.

Enable	<input checked="" type="checkbox"/>
Port	WAN
Connection Type	DHCP Client
MTU	1500
Use Peer DNS	<input type="checkbox"/>
IPv4 Primary DNS	114.114.114.114
IPv4 Secondary DNS	8.8.8.8
Enable NAT	<input checked="" type="checkbox"/>

Figure 3-2-1-8

Enable	<input checked="" type="checkbox"/>
Port	WAN
Connection Type	DHCPv6 Client
Request IPv6-address	None
Request IPv6-prefix of length	0-64
MTU	1500
IPv6 Primary DNS	2001:4860:4860::8888
IPv6 Secondary DNS	
Enable NAT	<input checked="" type="checkbox"/>

Figure 3-2-1-9

DHCP Client	
Item	Description
Use Peer DNS	Obtain peer DNS automatically during PPP dialing. DNS is necessary when visiting domain name.
DHCPv6 Client	
Request IPv6-address	Choose the ways to obtain the IPv6 address from the DHCP Server. Select from try, force, none. Try: The DHCP Server will assign specific address in priority. Force: The DHCP Server assigns specific address only. None: The DHCP Server will randomly assign address.The

	specific address is relevant to the prefix length of IPv6 address you set.
Request prefix length of IPv6	Set the prefix length of IPv6 address which router is expected to obtain from DHCP Server.

Table 3-2-1-8 DHCP Client Parameters

3. PPPoE/PPPoEv6

PPPoE refers to a point to point protocol over Ethernet. With PPPoE, remote access devices can get control of each user. If type as PPPoEv6, router can get both IPv4 and IPv6 address.

Enable	<input checked="" type="checkbox"/>
Port	WAN
Connection Type	PPPoE
Username	<input type="text"/>
Password	<input type="text"/>
Link Detection Interval(s)	60
Max Retries	0
MTU	1500
Use Peer DNS	<input type="checkbox"/>
Primary DNS	8.8.8.8
Secondary DNS	<input type="text"/>
Enable NAT	<input checked="" type="checkbox"/>

Figure 3-2-1-10

Enable	<input checked="" type="checkbox"/>
Port	WAN
Connection Type	PPPoEv6
Username	<input type="text"/>
Password	<input type="text"/>
Link Detection Interval(s)	60
Max Retries	0
MTU	1500
Use Peer DNS	<input type="checkbox"/>
IPv4 Primary DNS	114.114.114.114
IPv4 Secondary DNS	8.8.8.8
IPv6 Primary DNS	2001:4860:4860::8888
IPv6 Secondary DNS	<input type="text"/>
Enable NAT	<input checked="" type="checkbox"/>

Figure 3-2-1-11

PPPoE	
Item	Description
Username	Enter the username provided by your Internet Service Provider (ISP).
Password	Enter the password provided by your Internet Service Provider (ISP).
Link Detection Interval (s)	Set the heartbeat interval for link detection. Range: 1-600.
Max Retries	Set the maximum retry times after it fails to dial up. Range: 0-9.
Use Peer DNS	Obtain peer DNS automatically during PPP dialing. DNS is necessary when visiting domain name.

Table 3-2-1-9 PPOE Parameters

4. Dual-Stack Lite

Dual-Stack Lite (DS-Lite) uses IPv4-in-IPv6 tunneling to send a subscriber's IPv4 packet through a tunnel on the IPv6 access network to the ISP. The IPv6 packet is decapsulated to recover the subscriber's IPv4 packet and is then sent to the Internet after NAT address and port translation and other LSN related processing. The response packets traverse through the same path to the subscriber.

Figure 3-2-1-12

Dual-Stack Lite	
Item	Description
IPv6 Gateway	Set the gateway for WAN port's IPv6 address.
DS-Lite AFTR Address	Set the DS-Lite AFTR server address.
Local IPv6 Address	Set the WAN port IPv6 address which use the same subnet as IPv6 gateway.

Table 3-2-1-10 Dual-Stack Lite Parameters

Related Configuration Example

[Ethernet WAN Connection](#)

3.2.1.5 Bridge

Bridge setting is used for managing local area network devices which are connected to LAN ports of the UR75, allowing each of them to access the Internet.

The screenshot shows the 'Bridge Setting' configuration page. The 'Bridge' tab is selected. The configuration includes:

- Name: Bridge0
- STP:
- IP Address: 192.168.1.1
- Netmask: 255.255.255.0
- IPv6 Address: 2004::1/64
- MTU: 1500

Below the main settings is a section for 'Multiple IP Address' with a table header:

IP Address	Netmask	Operation
		<input style="background-color: #007bff; color: white; border: none; padding: 2px 5px;" type="button" value="+"/>

Figure 3-2-1-13

Bridge		
Item	Description	Default
Name	Show the name of bridge. "Bridge0" is set by default and cannot be changed.	Bridge0
STP	Enable/disable STP.	Disable
IP Address	Set the IP address for bridge.	192.168.1.1
Netmask	Set the Netmask for bridge.	255.255.255.0
IPv6 Address	Set the IPv6 address for bridge.	2004::1/64
MTU	Set the maximum transmission unit. Range: 68-1500.	1500
Multiple IP Address	Set the multiple IP addresses for bridge.	Null

Table 3-2-1-11 Bridge Settings

3.2.1.6 WLAN

This section explains how to set the related parameters for Wi-Fi network. UR75 supports both 2.4G and 5G Wi-Fi and it can work as AP or client mode at the same time.

Link Failover	Cellular	Port	WAN	Bridge	WLAN
WLAN1-2.4G					
Enable	<input checked="" type="checkbox"/>				
Work Mode	AP				
BSSID	24:e1:24:f0:d9:40				
Radio Type	802.11n(2.4GHz)				
Channel	Auto				
Bandwidth	20MHz				
SSID	Router_F0D940				
Encryption Mode	WPA-PSK/WPA2-PSK				
Cipher	Auto				
Key					
SSID Broadcast	<input type="checkbox"/>				
AP Isolation	<input type="checkbox"/>				
Guest Mode	<input type="checkbox"/>				

Figure 3-2-1-14

WLAN	
Item	Description
Enable	Enable/disable WLAN.
Work Mode	Select router's work mode. The options are "Client" or "AP".
SSID	Fill in the SSID of the access point.
BSSID	Fill in the MAC address of the access point. Either SSID or BSSID can be filled to join the network.
Encryption Mode	Select encryption mode. The options are "No Encryption", "WEP Open System", "WEP Shared Key", "WPA-PSK", "WPA2-PSK" and "WPA-PSK/WPA2-PSK".
Cipher	Select cipher. The options are "Auto", "AES", "TKIP" and "AES/TKIP".
Key	Fill in the key of access point.
Client Mode	
Scan	Click "Scan" button to search the nearby access point.
SSID	Show SSID.
Channel	Show wireless channel.
Signal	Show wireless signal.

BSSID	Show the MAC address of the access point.
Cipher	Show the cipher of the access point.
Security	Show the encryption mode.
Frequency	Show the frequency of radio.
Join Network	Click the button to join the wireless network.
AP Mode	
Radio Type	Select Radio type. 2.4G radio types can only be selected in WLAN 1 and 5G radio types can only be selected in WLAN2.
Channel	Select wireless channel. The options are "Auto", "1", "2"....."11".
Cipher	Select cipher. The options are "Auto", "AES", "TKIP" and "AES/TKIP".
Group Rekey Time	Rekeytime is when you select PSK encryption mode.
Bandwidth	Select bandwidth. The options are "20MHz" and "40MHz".
SSID Broadcast	When SSID broadcast is disabled, other wireless devices can't not find the SSID, and users have to enter the SSID manually to access to the wireless network.
AP Isolation	When AP isolation is enabled, all users that access to the AP are isolated without communication with each other.
Guest Mode	The internal network is not allowed to visit if the guest mode is enabled.
IP Setting	
Protocol	Set the IP address in wireless network.
IP Address	Set the IP address in wireless network.
Netmask	Set the netmask in wireless network.
Gateway	Set the gateway in wireless network.

Table 3-2-1-12 WLAN Parameters

MAC Filtering

Type: Allow and Block the Rest

MAC Address	Description	Operation
		+

Save & Apply

Figure 3-2-1-15

MAC Filtering	
Item	Description
Type	In this mode, you can choose the rule according to your security policy, which is 'Allow and Block the Rest' and 'Block and Allow the Rest', the default value is Disabled.
Allow and block the rest	Only the listed MAC addresses are allowed to connect to the router's wireless access point.

Block and allow the rest

The listed MAC addresses are not allowed to connect to the router's wireless access point.

Table 3-2-1-13 MAC Filtering Parameters

Related Topic

[Wi-Fi Application Example](#)

3.2.1.7 Switch

VLAN is a kind of new data exchange technology that realizes virtual work groups by logically dividing the LAN device into network segments.

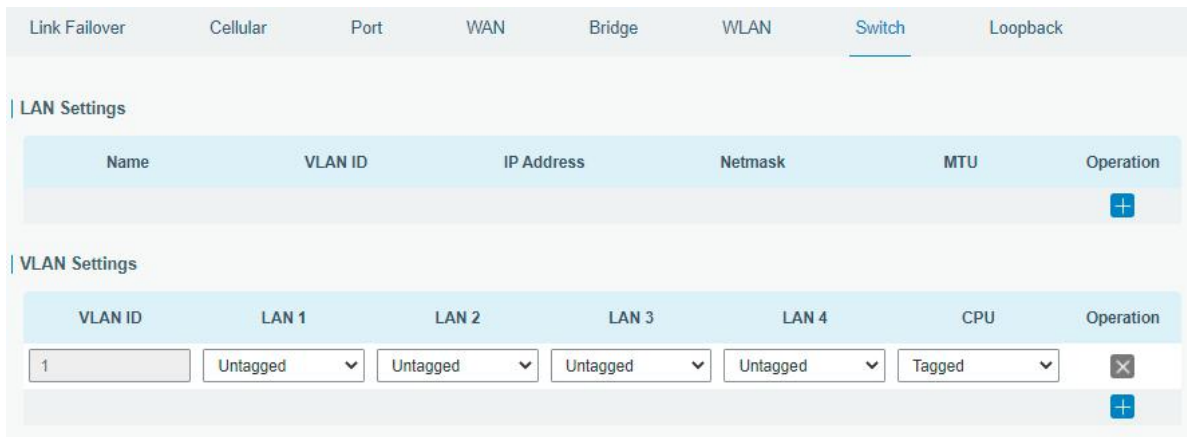

Figure 3-2-1-16

Switch	
Item	Description
LAN Settings	
Name	Set interface name of VLAN.
VLAN ID	Select VLAN ID of the interface.
IP Address	Set IP address of LAN port.
Netmask	Set Netmask of LAN port.
MTU	Set the maximum transmission unit of LAN port. Range: 68-1500.
VLAN Settings	
VLAN ID	Set the label ID of the VLAN. Range: 1-4094.
LAN 1/2/3/4	Make the VLAN bind with the corresponding ports and select status from "Tagged", "Untagged" and "Close" for Ethernet frame on trunk link.
CPU	Control communication between VLAN and other networks.

Table 3-2-1-14 VLAN Trunk Parameters

3.2.1.8 Loopback

Loopback interface is used for replacing router's ID as long as it is activated. When the interface is DOWN, the ID of the router has to be selected again which leads to long convergence time of OSPF. Therefore, Loopback interface is generally recommended as the ID of the router.

Loopback interface is a logic and virtual interface on router. Under default conditions, there's no loopback interface on router, but it can be created as required.

Figure 3-2-1-17

Loopback		
Item	Description	Default
IP Address	Unalterable	127.0.0.1
Netmask	Unalterable	255.0.0.0
Multiple IP Addresses	Apart from the IP above, user can configure other IP addresses.	Null

Table 3-2-1-15 Loopback Parameters

3.2.2 DHCP

DHCP adopts Client/Server communication mode. The Client sends configuration request to the Server which feeds back corresponding configuration information and distributes IP address to the Client so as to achieve the dynamic configuration of IP address and other information.

3.2.2.1 DHCP Server/DHCPv6 Server

UR75 can be set as a DHCP server or DHCPv6 server to distribute IP address when a host logs on and ensures each host is supplied with different IP addresses. DHCP Server has simplified some previous network management tasks requiring manual operations to the largest extent. UR75 only supports stateful DHCPv6 when working as DHCPv6 server.

DHCP Server DHCPv6 Server DHCP Relay

— DHCP Server_1

Enable

Interface

Start Address

End Address

Netmask

Lease Time(Min)

Primary DNS Server

Secondary DNS Server

Windows Name Server

Static IP

MAC Address	IP Address	Operation
		<input type="button" value="+"/>

Figure 3-2-2-1

DHCP Server DHCPv6 Server DHCP Relay

— DHCPv6 Server_1

Enable

Interface

Start Address

End Address

Prefix Length

Lease Time(Min)

Primary DNS Server

Secondary DNS Server

Static IP

DUID	IPv6 Address	Operation
		<input type="button" value="+"/>

Figure 3-2-2-2

DHCP Server/DHCPv6 Server		
Item	Description	Default
Enable	Enable or disable DHCP server.	Enable
Interface	Select interface.	Bridge0
Start Address	Define the beginning of the pool of IP addresses which will be leased to DHCP clients.	192.168.1.2
End Address	Define the end of the pool of IP addresses which will be leased to DHCP clients.	192.168.1.254
Netmask	Define the subnet mask of IPv4 address obtained by DHCP clients from DHCP server.	255.255.255.0

Prefix Length	Set the IPv6 prefix length of IPv6 address obtained by DHCP clients from DHCP server.	64
Lease Time (Min)	Set the lease time on which the client can use the IP address obtained from DHCP server. Range: 1-10080.	1440
Primary DNS Server	Set the primary DNS server.	192.168.1.1
Secondary DNS Server	Set the secondary DNS server.	Null
Windows Name Server	Define the Windows Internet Naming Service obtained by DHCP clients from DHCP sever. Generally you can leave it blank.	Null
Static IP		
MAC Address	Set a static and specific MAC address for the DHCP client (it should be different from other MACs so as to avoid conflict).	Null
DUID	Set a static and specific DUID for the DHCPv6 client (it should be different from other DUID so as to avoid conflict).	Null
IP Address	Set a static and specific IP address for the DHCP client (it should be outside of the DHCP range).	Null

Table 3-2-2-1 DHCP Server Parameters

3.2.2.2 DHCP Relay

UR75 can be set as DHCP Relay to provide a relay tunnel to solve the problem that DHCP Client and DHCP Server are not in the same subnet.

Figure 3-2-2-2

DHCP Relay	
Item	Description
Enable	Enable or disable DHCP relay.
DHCP Server	Set DHCP server, up to 10 servers can be configured; separate them by blank space or ",".

Table 3-2-2-2 DHCP Relay Parameters

3.2.3 Firewall

This section describes how to set the firewall parameters, including security, ACL, DMZ, Port Mapping, MAC Binding and SPI.

The firewall implements corresponding control of data flow at entry direction (from Internet to local area network) and exit direction (from local area network to Internet) according to the content features of packets, such as protocol style, source/destination IP address, etc. It ensures that the router operate in a safe environment and host in local area network.

3.2.3.1 Security

Service	Port	Local	Remote
HTTP	80	<input checked="" type="checkbox"/>	<input checked="" type="checkbox"/>
HTTPS	443	<input checked="" type="checkbox"/>	<input checked="" type="checkbox"/>
TELNET	23	<input checked="" type="checkbox"/>	<input checked="" type="checkbox"/>
SSH	22	<input checked="" type="checkbox"/>	<input checked="" type="checkbox"/>
FTP	21	<input type="checkbox"/>	<input checked="" type="checkbox"/>

Figure 3-2-3-1

Item	Description	Default
Prevent Attack		
DoS/DDoS Protection	Enable/disable Prevent DoS/DDoS Attack.	Disable
Access Service Control		
Port	Set port number of the services. Range: 1-65535.	--
Local	Access the router locally.	Enable
Remote	Access the router remotely.	Disable

HTTP	Users can log in the device locally via HTTP to access and control it through Web after the option is checked.	80
HTTPS	Users can log in the device locally and remotely via HTTPS to access and control it through Web after option is checked.	443
TELNET	Users can log in the device locally and remotely via Telnet after the option is checked.	23
SSH	Users can log in the device locally and remotely via SSH after the option is checked.	22
FTP	Users can log in the device locally and remotely via FTP after the option is checked.	21
Website Blocking		
URL Blocking	Enter the HTTP address which you want to block.	
Keyword Blocking	You can block specific website by entering keyword. The maximum number of character allowed is 64.	

Table 3-2-3-1 Security Parameters

3.2.3.2 ACL

Access control list, also called ACL, implements permission or prohibition of access for specified network traffic (such as the source IP address) by configuring a series of matching rules so as to filter the network interface traffic. When router receives packet, the field will be analyzed according to the ACL rule applied to the current interface. After the special packet is identified, the permission or prohibition of corresponding packet will be implemented according to preset strategy.

The data package matching rules defined by ACL can also be used by other functions requiring flow distinction.

The screenshot displays the ACL configuration interface. At the top, there are navigation tabs: Security, ACL (selected), Port Mapping, DMZ, MAC Binding, Custom Rules, and SPI. The main content area is divided into sections:

- ACL Setting:** A dropdown menu for 'Default Filter Policy' is currently set to 'Accept'.
- Access Control List:** A table with columns: ID, Action, Protocol, Source IP, Destination IP, More Detail, Description, and Operation. A blue '+' button is present at the bottom right of this table to add a new rule.
- Interface List:** A table with columns: Interface, In ACL, Out ACL, and Operation. A blue '+' button is present at the bottom right of this table to add a new interface.

A 'Save' button is located at the bottom left of the configuration area.

Figure 3-2-3-2

Item	Description
ACL Setting	
Default Filter Policy	Select from "Accept" and "Deny". The packets which are not included in the access control list will be processed by the default filter policy.
Access Control List	
Type	Select type from "Extended" and "Standard".
ID	User-defined ACL number. Range: 1-199.
Action	Select from "Permit" and "Deny".
Protocol	Select protocol from "ip", "icmp", "tcp", "udp", and "1-255".
Source IP	Source network address (leaving it blank means all).
Source Wildcard Mask	Wildcard mask of the source network address.
Destination IP	Destination network address (0.0.0.0 means all).
Destination Wildcard Mask	Wildcard mask of destination address.
Description	Fill in a description for the groups with the same ID.
ICMP Type	Enter the type of ICMP packet. Range: 0-255.
ICMP Code	Enter the code of ICMP packet. Range: 0-255.
Source Port Type	Select source port type, such as specified port, port range, etc.
Source Port	Set source port number. Range: 1-65535.
Start Source Port	Set start source port number. Range: 1-65535.
End Source Port	Set end source port number. Range: 1-65535.
Destination Port Type	Select destination port type, such as specified port, port range, etc.
Destination Port	Set destination port number. Range: 1-65535.
Start Destination Port	Set start destination port number. Range: 1-65535.
End Destination Port	Set end destination port number. Range: 1-65535.
More Details	Show information of the port.
Interface List	
Interface	Select network interface for access control.
In ACL	Select a rule for incoming traffic from ACL ID.
Out ACL	Select a rule for outgoing traffic from ACL ID.

Table 3-2-3-2 ACL Parameters

Related Configuration Example

[Access Control Application Example](#)

3.2.3.3 Port Mapping

Port mapping is an application of network address translation (NAT) that redirects a communication request from the combination of an address and port number to another while the packets are

traversing a network gateway such as a router or firewall.

Click  to add a new port mapping rules.

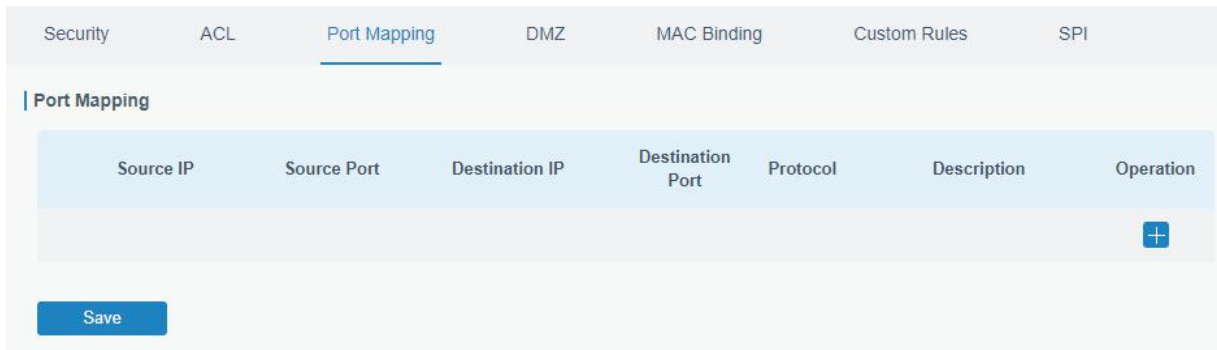

Figure 3-2-3-3

Port Mapping	
Item	Description
Source IP	Specify the host or network which can access local IP address. 0.0.0.0/0 means all.
Source Port	Enter the TCP or UDP port from which incoming packets are forwarded. Range: 1-65535.
Destination IP	Enter the IP address that packets are forwarded to after being received on the incoming interface.
Destination Port	Enter the TCP or UDP port that packets are forwarded to after being received on the incoming port(s). Range: 1-65535.
Protocol	Select from "TCP" and "UDP" as your application required.
Description	The description of this rule.

Table 3-2-3-3 Port Mapping Parameters

Related Configuration Example

[NAT Application Example](#)

3.2.3.4 DMZ

DMZ is a host within the internal network that has all ports exposed, except those forwarded ports in port mapping.

Figure 3-2-3-4

DMZ	
Item	Description
Enable	Enable or disable DMZ.
DMZ Host	Enter the IP address of the DMZ host on the internal network.
Source Address	Set the source IP address which can access to DMZ host. "0.0.0.0/0" means any address.

Table 3-2-3-4 DMZ Parameters

3.2.3.5 MAC Binding

MAC Binding is used for specifying hosts by matching MAC addresses and IP addresses that are in the list of allowed outer network access.

Figure 3-2-3-5

MAC Binding List	
Item	Description
MAC Address	Set the binding MAC address.
IP Address	Set the binding IP address.
Description	Fill in a description for convenience of recording the meaning of the binding rule for each piece of MAC-IP.

Table 3-2-3-5 MAC Binding Parameters

3.2.3.6 Custom Rules

In this page, you can configure your own custom firewall iptables rules.

Figure 3-2-3-6

Custom Rules	
Item	Description
Rule	Specify an iptables rule like the example shows. Tips: You must reboot the device to take effect after modifying or deleting the iptables rules.
Description	Enter the description of the rule.

Table 3-2-3-6 Custom Rules Parameters

3.2.3.7 SPI

Figure 3-2-3-7

SPI Firewall	
Item	Description
Enable	Enable/disable SPI firewall.
Filter Proxy	Blocks HTTP requests containing the "Host": string.
Filter Cookies	Identifies HTTP requests that contain "Cookie": String and mangle the cookie. Attempts to stop cookies from being used.

Filter ActiveX	Blocks HTTP requests of the URL that ends in ".ocx" or ".cab".
Filter Java Applets	Blocks HTTP requests of the URL that ends in ".js" or ".class".
Filter Multicast	Prevent multicast packets from reaching the LAN.
Filter IDENT(port 113)	Prevent WAN access to Port 113.
Block WAN SNMP access	Block SNMP requests from the WAN.
Filter WAN NAT Redirection	Prevent hosts on LAN from using WAN address of router to connect servers on the LAN (which have been configured using port redirection).
Block Anonymous WAN Requests	Stop the router from responding to "pings" from the WAN.

Table 3-2-3-7 SPI Parameters

3.2.4 QoS

Quality of service (QoS) refers to traffic prioritization and resource reservation control mechanisms rather than the achieved service quality. QoS is engineered to provide different priority for different applications, users, data flows, or to guarantee a certain level of performance to a data flow.

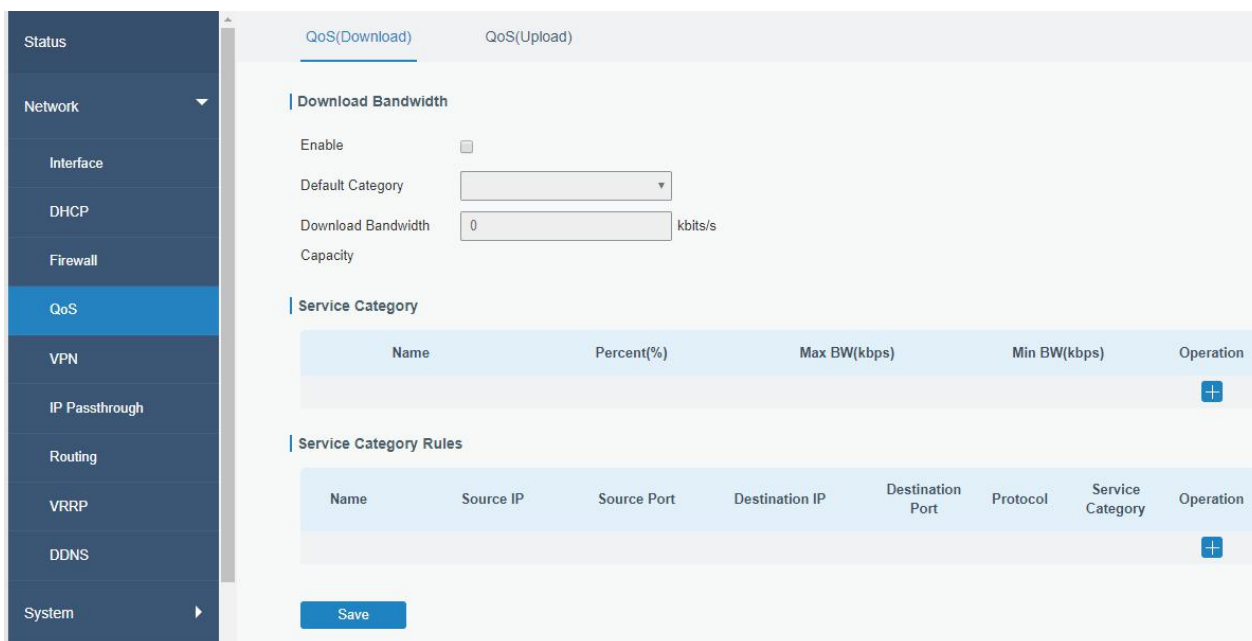

Figure 3-2-4-1

QoS	
Item	Description
Download/Upload	
Enable	Enable or disable QoS.
Default Category	Select the default category from Service Category list.
Download/Upload Bandwidth Capacity	The download/upload bandwidth capacity of the network that the router is connected with, in kbps. Range: 1-8000000.
Service Category	
Name	You can use characters such digits, letters and "-".

Percent (%)	Set percent for the service category. Range: 0-100.
Max BW(kbps)	The maximum bandwidth that this category is allowed to consume, in kbps. The value should be less than the "Download/Upload Bandwidth Capacity" when the traffic is blocked.
Min BW(kbps)	The minimum bandwidth that can be guaranteed for the category, in kbps. The value should be less than the "MAX BW" value.
Service Category Rules	
Item	Description
Name	Give the rule a descriptive name.
Source IP	Source address of flow control (leaving it blank means any).
Source Port	Source port of flow control. Range: 0-65535 (leaving it blank means any).
Destination IP	Destination address of flow control (leaving it blank means any).
Destination Port	Destination port of flow control. Range: 0-65535 (leaving it blank means any).
Protocol	Select protocol from "ANY", "TCP", "UDP", "ICMP", and "GRE".
Service Category	Set service category for the rule.

Table 3-2-4-1 QoS (Download/Upload) Parameters

Related Configuration Example

[QoS Application Example](#)

3.2.5 VPN

Virtual Private Networks, also called VPNs, are used to securely connect two private networks together so that devices can connect from one network to the other network via secure channels.

The UR75 supports DMVPN, IPsec, GRE, L2TP, PPTP, OpenVPN, as well as GRE over IPsec and L2TP over IPsec.

3.2.5.1 DMVPN

A dynamic multi-point virtual private network (DMVPN), combining mGRE and IPsec, is a secure network that exchanges data between sites without passing traffic through an organization's headquarter VPN server or router.

The screenshot displays the 'DMVPN Settings' configuration page. The left sidebar contains a navigation menu with categories like Network, System, Industrial, Maintenance, and APP. The main content area is titled 'DMVPN Settings' and lists various configuration parameters with input fields or dropdown menus. A 'Save' button is located at the bottom left of the settings area.

Figure 3-2-5-1

DMVPN	
Item	Description
Enable	Enable or disable DMVPN.
Hub Address	The IP address or domain name of DMVPN Hub.
Local IP address	DMVPN local tunnel IP address.
GRE Hub IP Address	GRE Hub tunnel IP address.
GRE Local IP Address	GRE local tunnel IP address.
GRE Netmask	GRE local tunnel netmask.
GRE Key	GRE tunnel key.
Negotiation Mode	Select from "Main" and "Aggressive".
Authentication Algorithm	Select from "DES", "3DES", "AES128", "AES192" and "AES256".
Encryption Algorithm	Select from "MD5" and "SHA1".
DH Group	Select from "MODP768_1", "MODP1024_2" and "MODP1536_5".
Key	Enter the preshared key.
Local ID Type	Select from "Default", "ID", "FQDN", and "User FQDN"
IKE Life Time (s)	Set the lifetime in IKE negotiation. Range: 60-86400.
SA Algorithm	Select from "DES_MD5", "DES_SHA1", "3DES_MD5", "3DES_SHA1", "AES128_MD5", "AES128_SHA1", "AES192_MD5", "AES192_SHA1", "AES256_MD5" and "AES256_SHA1".
PFS Group	Select from "NULL", "MODP768_1", "MODP1024_2" and

	"MODP1536-5".
Life Time (s)	Set the lifetime of IPsec SA. Range: 60-86400.
DPD Interval Time (s)	Set DPD interval time
DPD Timeout (s)	Set DPD timeout.
Cisco Secret	Cisco Nhrp key.
NHRP Holdtime (s)	The holdtime of NHRP protocol.

Table 3-2-5-1 DMVPN Parameters

3.2.5.2 IPsec Server

IPsec is especially useful for implementing virtual private networks and for remote user access through dial-up connection to private networks. A big advantage of IPsec is that security arrangements can be handled without requiring changes to individual user computers.

IPsec provides three choices of security service: Authentication Header (AH), Encapsulating Security Payload (ESP), and Internet Key Exchange (IKE). AH essentially allows authentication of the senders' data. ESP supports both authentication of the sender and data encryption. IKE is used for cipher code exchange. All of them can protect one and more data flows between hosts, between host and gateway, and between gateways.

DMVPN	IPsec Server	IPsec	GRE	L2TP
IPsec Server				
Enable		<input type="checkbox"/>		
IPsec Mode		Tunnel		
IPsec Protocol		ESP		
Local Subnet				
Local Subnet Mask				
Local ID Type		Default		
Remote Subnet				
Remote Subnet Mask				
Remote ID Type		Default		
IKE Parameter		<input type="checkbox"/>		
SA Parameter		<input type="checkbox"/>		
IPsec Advanced		<input type="checkbox"/>		
Expert Options				
Save				

Figure 3-2-5-2

IPsec Server	
Item	Description
Enable	Enable IPsec tunnel. A maximum of 3 tunnels is allowed.
IPsec Mode	Select from "Tunnel" and "Transport".
IPsec Protocol	Select from "ESP" and "AH".
Local Subnet	Enter the local subnet IP address that IPsec protects.
Local Subnet Netmask	Enter the local netmask that IPsec protects.
Local ID Type	Select from "Default", "ID", "FQDN", and "User FQDN".
Remote Subnet	Enter the remote subnet IP address that IPsec protects.
Remote Subnet Mask	Enter the remote netmask that IPsec protects.
Remote ID type	Select from "Default", "ID", "FQDN", and "User FQDN".

Table 3-2-5-2 IPsec Parameters

IKE Parameter

IKE Version

Negotiation Mode

Encryption Algorithm

Authentication Algorithm

DH Group

Local Authentication

XAUTH

Lifetime(s)

XAUTH List

Username	Password	Operation
		+

PSK List

Selector	PSK	Operation
		+

Figure 3-2-5-3

SA Parameter

SAAlgorithm

PFS Group

Lifetime(s)

DPD Time Interval(s)

DPD Timeout(s)

IPsec Advanced

Enable Compression

VPN Over IPsec Type

Expert Options

Figure 3-2-5-4

IKE Parameter	
Item	Description
IKE Version	Select from "IKEv1" and "IKEv2".
Negotiation Mode	Select from "Main" and "Aggressive".
Encryption Algorithm	Select from "DES", "3DES", "AES128", "AES192" and "AES256".
Authentication Algorithm	Select from "MD5" and "SHA1"
DH Group	Select from "MODP768_1", "MODP1024_2" and "MODP1536_5".
Local Authentication	Select from "PSK" and "CA".
XAUTH	Enter XAUTH username and password after XAUTH is enabled.

Lifetime (s)	Set the lifetime in IKE negotiation. Range: 60-86400.
XAUTH List	
Username	Enter the username used for the xauth authentication.
Password	Enter the password used for the xauth authentication.
PSK List	
Selector	Enter the corresponding identification number for PSK authentication.
PSK	Enter the pre-shared key.
SA Parameter	
SA Algorithm	Select from "DES_MD5", "DES_SHA1", "3DES_MD5", "3DES_SHA1", "AES128_MD5", "AES128_SHA1", "AES192_MD5", "AES192_SHA1", "AES256_MD5" and "AES256_SHA1".
PFS Group	Select from "NULL", "MODP768_1", "MODP1024_2" and "MODP1536_5".
Lifetime (s)	Set the lifetime of IPsec SA. Range: 60-86400.
DPD Interval Time(s)	Set DPD interval time to detect if the remote side fails.
DPD Timeout(s)	Set DPD timeout. Range: 10-3600.
IPsec Advanced	
Enable Compression	The head of IP packet will be compressed after it's enabled.
VPN Over IPsec Type	Select from "NONE", "GRE" and "L2TP" to enable VPN over IPsec function.
Expert Options	User can enter some other initialization strings in this field and separate the strings with ";". For example, if more local or remote subnet need to be added, users can add contents here.

Table 3-2-5-3 IPsec Server Parameters

3.2.5.3 IPsec

Figure 3-2-5-5

IPsec	
Item	Description
Enable	Enable IPsec tunnel. A maximum of 3 tunnels is allowed.
IPsec Gateway Address	Enter the IP address or domain name of remote IPsec server.
IPsec Mode	Select from "Tunnel" and "Transport".
IPsec Protocol	Select from "ESP" and "AH".
Local Subnet	Enter the local subnet IP address that IPsec protects.
Local Subnet Netmask	Enter the local netmask that IPsec protects.
Local ID Type	Select from "Default", "ID", "FQDN", and "User FQDN".
Remote Subnet	Enter the remote subnet IP address that IPsec protects.
Remote Subnet Mask	Enter the remote netmask that IPsec protects.
Remote ID type	Select from "Default", "ID", "FQDN", and "User FQDN".

Table 3-2-5-4 IPsec Parameters

IKE Parameter	<input checked="" type="checkbox"/>
IKE Version	IKEv1
Negotiation Mode	Main
Encryption Algorithm	AES128
Authentication Algorithm	SHA1
DH Group	MODP768-1
Local Authentication	PSK
Local Secrets
XAUTH	<input checked="" type="checkbox"/>
Username	
Password	
Lifetime(s)	28800
SA Parameter	<input type="checkbox"/>
IPsec Advanced	<input checked="" type="checkbox"/>
Enable Compression	<input checked="" type="checkbox"/>
VPN Over IPsec Type	NONE
Expert Options	

Figure 3-2-5-6

IKE Parameter	
Item	Description
IKE Version	Select from "IKEv1" and "IKEv2".
Negotiation Mode	Select from "Main" and "Aggressive".
Encryption Algorithm	Select from "DES", "3DES", "AES128", "AES192" and "AES256".
Authentication Algorithm	Select from "MD5" and "SHA1"
DH Group	Select from "MODP768_1", "MODP1024_2" and "MODP1536_5".
Local Authentication	Select from "PSK" and "CA".
Local Secrets	Enter the pre-shared key.
XAUTH	Enter XAUTH username and password after XAUTH is enabled.
Lifetime (s)	Set the lifetime in IKE negotiation. Range: 60-86400.
SA Parameter	
SA Algorithm	Select from "DES_MD5", "DES_SHA1", "3DES_MD5", "3DES_SHA1", "AES128_MD5", "AES128_SHA1", "AES192_MD5", "AES192_SHA1", "AES256_MD5" and "AES256_SHA1".
PFS Group	Select from "NULL", "MODP768_1", "MODP1024_2" and

	"MODP1536_5".
Lifetime (s)	Set the lifetime of IPsec SA. Range: 60-86400.
DPD Interval Time(s)	Set DPD interval time to detect if the remote side fails.
DPD Timeout(s)	Set DPD timeout. Range: 10-3600.
IPsec Advanced	
Enable Compression	The head of IP packet will be compressed after it's enabled.
VPN Over IPsec Type	Select from "NONE", "GRE" and "L2TP" to enable VPN over IPsec function.
Expert Option	User can enter some other initialization strings in this field and separate the strings with “;”. For example, if more local or remote subnet need to be added, users can add contents here.

Table 3-2-5-5 IPsec Parameters

3.2.5.4 GRE

Generic Routing Encapsulation (GRE) is a protocol that encapsulates packets in order to route other protocols over IP networks. It's a tunneling technology that provides a channel through which encapsulated data message could be transmitted and encapsulation and decapsulation could be realized at both ends.

In the following circumstances the GRE tunnel transmission can be applied:

- GRE tunnel could transmit multicast data packets as if it were a true network interface. Single use of IPsec cannot achieve the encryption of multicast.
- A certain protocol adopted cannot be routed.
- A network of different IP addresses shall be required to connect other two similar networks.

The screenshot displays the configuration page for GRE tunneling. At the top, there are navigation tabs: DMVPN, IPsec Server, IPsec, GRE (highlighted), L2TP, PPTP, and OpenVPN Client. Below the tabs, the 'GRE Settings' section is visible, with a sub-section for 'GRE_1'. The settings include:

- Enable:** A toggle switch that is currently turned off.
- Remote IP Address:** An empty text input field.
- Local IP Address:** An empty text input field.
- Local Virtual IP Address:** An empty text input field.
- Netmask:** A text input field containing the value '255.255.255.0'.
- Peer Virtual IP Address:** An empty text input field.
- Global Traffic Forwarding:** A toggle switch that is currently turned off.
- Remote Subnet:** An empty text input field.
- Remote Netmask:** An empty text input field.
- MTU:** A text input field containing the value '1500'.
- Key:** An empty text input field.
- Enable NAT:** A checked checkbox.

Figure 3-2-5-7

GRE	
Item	Description
Enable	Check to enable GRE function.
Remote IP Address	Enter the real remote IP address of GRE tunnel.
Local IP Address	Set the local IP address.
Local Virtual IP Address	Set the local tunnel IP address of GRE tunnel.
Netmask	Set the local netmask.
Peer Virtual IP Address	Enter remote tunnel IP address of GRE tunnel.
Global Traffic Forwarding	All the data traffic will be sent out via GRE tunnel when this function is enabled.
Remote Subnet	Enter the remote subnet IP address of GRE tunnel.
Remote Netmask	Enter the remote netmask of GRE tunnel.
MTU	Enter the maximum transmission unit. Range: 64-1500.
Key	Set GRE tunnel key.
Enable NAT	Enable NAT traversal function.

Table 3-2-5-6 GRE Parameters

3.2.5.5 L2TP

Layer Two Tunneling Protocol (L2TP) is an extension of the Point-to-Point Tunneling Protocol (PPTP) used by an Internet service provider (ISP) to enable the operation of a virtual private network (VPN) over the Internet.

The screenshot displays the 'L2TP Settings' configuration page. At the top, there are navigation tabs for DMVPN, IPsec Server, IPsec, GRE, L2TP (selected), PPTP, and OpenVPN Client. Below the tabs, the 'L2TP Settings' section is expanded to show 'L2TP_1'. The settings include:

- Enable:**
- Remote IP Address:**
- Username:**
- Password:**
- Authentication:**
- Global Traffic Forwarding:**
- Key:**
- Advanced Settings:**

Figure 3-2-5-8

L2TP	
Item	Description
Enable	Check to enable L2TP function.
Remote IP Address	Enter the public IP address or domain name of L2TP server.
Username	Enter the username that L2TP server provides.
Password	Enter the password that L2TP server provides.
Authentication	Select from "Auto", "PAP", "CHAP", "MS-CHAPv1" and "MS-CHAPv2".
Global Traffic Forwarding	All of the data traffic will be sent out via L2TP tunnel after this function is enabled.
Remote Subnet	Enter the remote IP address that L2TP protects.
Remote Subnet Mask	Enter the remote netmask that L2TP protects.
Key	Enter the password of L2TP tunnel.

Table 3-2-5-7 L2TP Parameters

Advanced Settings	<input checked="" type="checkbox"/>
Local IP Address	<input type="text"/>
Peer IP Address	<input type="text"/>
Enable NAT	<input checked="" type="checkbox"/>
Enable MPPE	<input checked="" type="checkbox"/>
Address/Control Compression	<input type="checkbox"/>
Protocol Field Compression	<input type="checkbox"/>
Asyncmap Value	<input type="text" value="ffffff"/>
MRU	<input type="text" value="1500"/>
MTU	<input type="text" value="1500"/>
Link Detection Interval(s)	<input type="text" value="60"/>
Max Retries	<input type="text" value="0"/>
Expert Options	<input type="text"/>

Figure 3-2-5-9

Advanced Settings	
Item	Description
Local IP Address	Set tunnel IP address of L2TP client. Client will obtain tunnel IP address automatically from the server when it's null.
Peer IP Address	Enter tunnel IP address of L2TP server.
Enable NAT	Enable NAT traversal function.
Enable MPPE	Enable MPPE encryption.

Address/Control Compression	For PPP initialization. User can keep the default option.
Protocol Field Compression	For PPP initialization. User can keep the default option.
Asyncmap Value	One of the PPP protocol initialization strings. User can keep the default value. Range: 0-ffffff.
MRU	Set the maximum receive unit. Range: 64-1500.
MTU	Set the maximum transmission unit. Range: 64-1500
Link Detection Interval (s)	Set the link detection interval time to ensure tunnel connection. Range: 0-600.
Max Retries	Set the maximum times of retry to detect the L2TP connection failure. Range: 0-10.
Expert Options	User can enter some other PPP initialization strings in this field and separate the strings with blank space.

Table 3-2-5-8 L2TP Parameters

3.2.5.6 PPTP

Point-to-Point Tunneling Protocol (PPTP) is a protocol that allows corporations to extend their own corporate network through private "tunnels" over the public Internet. Effectively, a corporation uses a wide-area network as a single large local area network.

Figure 3-2-5-10

PPTP	
Item	Description
Enable	Enable PPTP client. A maximum of 3 tunnels is allowed.
Remote IP Address	Enter the public IP address or domain name of PPTP server.
Username	Enter the username that PPTP server provides.
Password	Enter the password that PPTP server provides.
Authentication	Select from "Auto", "PAP", "CHAP", "MS-CHAPv1", and "MS-CHAPv2".
Global Traffic Forwarding	All of the data traffic will be sent out via PPTP tunnel once enable this function.
Remote Subnet	Set the peer subnet of PPTP.
Remote Subnet Mask	Set the netmask of peer PPTP server.

Table 3-2-5-9 PPTP Parameters

Advanced Settings	<input checked="" type="checkbox"/>
Local IP Address	<input type="text"/>
Peer IP Address	<input type="text"/>
Enable NAT	<input checked="" type="checkbox"/>
Enable MPPE	<input checked="" type="checkbox"/>
Address/Control Compression	<input type="checkbox"/>
Protocol Field Compression	<input type="checkbox"/>
Asyncmap Value	<input type="text" value="ffffff"/>
MRU	<input type="text" value="1500"/>
MTU	<input type="text" value="1500"/>
Link Detection Interval(s)	<input type="text" value="60"/>
Max Retries	<input type="text" value="0"/>
Expert Options	<input type="text"/>

Figure 3-2-5-11

PPTP Advanced Settings	
Item	Description
Local IP Address	Set IP address of PPTP client.
Peer IP Address	Enter tunnel IP address of PPTP server.
Enable NAT	Enable the NAT faction of PPTP.
Enable MPPE	Enable MPPE encryption.
Address/Control Compression	For PPP initialization. User can keep the default option.
Protocol Field	For PPP initialization. User can keep the default option.

Compression	
Asyncmap Value	One of the PPP protocol initialization strings. User can keep the default value. Range: 0-ffffff.
MRU	Enter the maximum receive unit. Range: 0-1500.
MTU	Enter the maximum transmission unit. Range: 0-1500.
Link Detection Interval (s)	Set the link detection interval time to ensure tunnel connection. Range: 0-600.
Max Retries	Set the maximum times of retrying to detect the PPTP connection failure. Range: 0-10.
Expert Options	User can enter some other PPP initialization strings in this field and separate the strings with blank space.

Table 3-2-5-10 PPTP Parameters

Related Configuration Example

[PPTP Application Example](#)

3.2.5.7 OpenVPN Client

OpenVPN is an open source virtual private network (VPN) product that offers a simplified security framework, modular network design, and cross-platform portability.

Advantages of OpenVPN include:

- Security provisions that function against both active and passive attacks.
- Compatibility with all major operating systems.
- High speed (1.4 megabytes per second typically).
- Ability to configure multiple servers to handle numerous connections simultaneously.
- All encryption and authentication features of the OpenSSL library.
- Advanced bandwidth management.
- A variety of tunneling options.
- Compatibility with smart cards that support the Windows Crypt application program interface (API).

DMVPN IPsec GRE L2TP PPTP OpenVPN Client OpenVPN Server Certificatio

OpenVPN Client Settings

— OpenVPN_1

Enable

Protocol

Remote IP Address

Port

Interface

Authentication

Local Tunnel IP

Remote Tunnel IP

Enable NAT

Compression

Link Detection Interval(s)

Link Detection Timeout(s)

Cipher

MTU

Max Frame Size

Verbose Level

Expert Options

Local Route

Subnet	Subnet Mask	Operation
		<input type="button" value="+"/>

Figure 3-2-5-12

OpenVPN Client	
Item	Description
Enable	Enable OpenVPN client. A maximum of 3 tunnels is allowed.
Protocol	Select from "UDP" and "TCP".
Remote IP Address	Enter remote OpenVPN server's IP address or domain name.
Port	Enter the listening port number of remote OpenVPN server. Range: 1-65535.
Interface	Select from "tun" and "tap".
Authentication	Select from "None", "Pre-shared", "Username/Password", "X.509 cert", and "X.509 cert+user".
Local Tunnel IP	Set local tunnel address.
Remote Tunnel IP	Enter remote tunnel address.
Global Traffic Forwarding	All the data traffic will be sent out via OpenVPN tunnel when this function is enabled.
Enable TLS Authentication	Check to enable TLS authentication.
Username	Enter username provided by OpenVPN server.
Password	Enter password provided by OpenVPN server.

Enable NAT	Enable NAT traversal function.
Compression	Select LZO to compress data.
Link Detection Interval (s)	Set link detection interval time to ensure tunnel connection. Range: 10-1800.
Link Detection Timeout (s)	Set link detection timeout. OpenVPN will be reestablished after timeout. Range: 60-3600.
Cipher	Select from "NONE", "BF-CBC", "DE-CBC", "DES-EDE3-CBC", "AES-128-CBC", "AES-192-CBC" and "AES-256-CBC".
MTU	Enter the maximum transmission unit. Range: 128-1500.
Max Frame Size	Set the maximum frame size. Range: 128-1500.
Verbose Level	Select from "ERROR", "WARNING", "NOTICE" and "DEBUG".
Expert Options	User can enter some other PPP initialization strings in this field and separate the strings with blank space.
Local Route	
Subnet	Set the local route's IP address.
Subnet Mask	Set the local route's netmask.

Table 3-2-5-11 OpenVPN Client Parameters

3.2.5.8 OpenVPN Server

The UR75 supports OpenVPN server to create secure point-to-point or site-to-site connections in routed or bridged configurations and remote access facilities.

The screenshot displays the 'OpenVPN Server' configuration page. At the top, there are navigation tabs for DMVPN, IPsec, GRE, L2TP, PPTP, OpenVPN Client, and OpenVPN Server. The 'OpenVPN Server' tab is active. Below the tabs, the 'OpenVPN Server Settings' section is visible. The settings are as follows:

- Enable:
- Protocol: UDP (dropdown)
- Port: 1194 (text input)
- Listening IP: (text input)
- Interface: tun (dropdown)
- Authentication: None (dropdown)
- Local Virtual IP: (text input)
- Remote Virtual IP: (text input)
- Enable NAT:
- Compression: LZO (dropdown)
- Link Detection Interval: 60 (text input)
- Cipher: None (dropdown)
- MTU: 1500 (text input)
- Max Frame Size: 1500 (text input)
- Verbose Level: ERROR (dropdown)
- Expert Options: (text input)

Figure 3-2-5-13

The screenshot shows two configuration sections: 'Local Route' and 'Account'. Each section has a table with columns for configuration fields and an 'Operation' column with a '+' icon.

Local Route		
Subnet	Netmask	Operation
		+

Account		
Username	Password	Operation
		+

Figure 3-2-5-14

OpenVPN Server	
Item	Description
Enable	Enable/disable OpenVPN server.
Protocol	Select from TCP and UDP.
Port	Fill in listening port number. Range: 1-65535.
Listening IP	Enter WAN IP address or LAN IP address. Leaving it blank refers to all active WAN IP and LAN IP address.
Interface	Select from "tun" and "tap".
Authentication	Select from "None", "Pre-shared", "Username/Password", "X.509 cert" and "X. 509 cert +user".
Local Virtual IP	The local tunnel address of OpenVPN's tunnel.
Remote Virtual IP	The remote tunnel address of OpenVPN's tunnel.
Client Subnet	Local subnet IP address of OpenVPN client.
Client Netmask	Local netmask of OpenVPN client.
Renegotiation Interval(s)	Set interval for renegotiation. Range: 0-86400.
Max Clients	Maximum OpenVPN client number. Range: 1-128.
Enable CRL	Enable CRL
Enable Client to Client	Allow access between different OpenVPN clients.
Enable Dup Client	Allow multiple users to use the same certification.
Enable NAT	Check to enable the NAT traversal function.
Compression	Select "LZO" to compress data.
Link Detection Interval	Set link detection interval time to ensure tunnel connection. Range: 10-1800.
Cipher	Select from "NONE", "BF-CBC", "DES-CBC", "DES-EDE3-CBC", "AES-128-CBC", "AES-192-CBC" and "AES-256-CBC".
MTU	Enter the maximum transmission unit. Range: 64-1500.
Max Frame Size	Set the maximum frame size. Range: 64-1500.
Verbose Level	Select from "ERROR", "WARNING", "NOTICE" and "DEBUG".
Expert Options	User can enter some other PPP initialization strings in this field and separate the strings with blank space.
Local Route	
Subnet	The real local IP address of OpenVPN client.
Netmask	The real local netmask of OpenVPN client.

Account

Username & Password	Set username and password for OpenVPN client.
---------------------	---

Table 3-2-5-12 OpenVPN Server Parameters

3.2.5.9 Certifications

User can import/export certificate and key files for OpenVPN and IPsec on this page.

Figure 3-2-5-15

OpenVPN Client	
Item	Description
CA	Import/Export CA certificate file.
Public Key	Import/Export public key file.
Private Key	Import/Export private key file.
TA	Import/Export TA key file.
Preshared Key	Import/Export static key file.
PKCS12	Import/Export PKCS12 certificate file.

Table 3-2-5-13 OpenVPN Client Certification Parameters

OpenVPN Server

— OpenVPN Server

CA	<input type="text"/>	Browse	Import	Export	Delete
Public Key	<input type="text"/>	Browse	Import	Export	Delete
Private Key	<input type="text"/>	Browse	Import	Export	Delete
DH	<input type="text"/>	Browse	Import	Export	Delete
TA	<input type="text"/>	Browse	Import	Export	Delete
CRL	<input type="text"/>	Browse	Import	Export	Delete
Preshared Key	<input type="text"/>	Browse	Import	Export	Delete

Figure 3-2-5-16

OpenVPN Server	
Item	Description
CA	Import/Export CA certificate file.
Public Key	Import/Export public key file.
Private Key	Import/Export private key file.
DH	Import/Export DH key file.
TA	Import/Export TA key file.
CRL	Import/Export CRL.
Preshared Key	Import/Export static key file.

Table 3-2-5-14 OpenVPN Server Parameters

IPsec

— IPsec_1

CA	<input type="text"/>	Browse	Import	Export	Delete
Client Key	<input type="text"/>	Browse	Import	Export	Delete
Server Key	<input type="text"/>	Browse	Import	Export	Delete
Private Key	<input type="text"/>	Browse	Import	Export	Delete
CRL	<input type="text"/>	Browse	Import	Export	Delete

Figure 3-2-5-17

IPsec	
Item	Description
CA	Import/Export CA certificate.
Client Key	Import/Export client key.
Server Key	Import/Export server key.
Private Key	Import/Export private key.

CRL	Import/Export certificate recovery list.
-----	--

Table 3-2-5-15 IPsec Parameters



Figure 3-2-5-18

IPsec Server	
Item	Description
CA	Import/Export CA certificate.
Local Certificate	Import/Export Local Certificate file.
Private Key	Import/Export private key.
CRL	Import/Export certificate recovery list.

Table 3-2-5-16 IPsec Server Parameters

3.2.6 IP Passthrough

IP Passthrough mode shares or "passes" the Internet providers assigned IP address to a single LAN client device connected to the router.

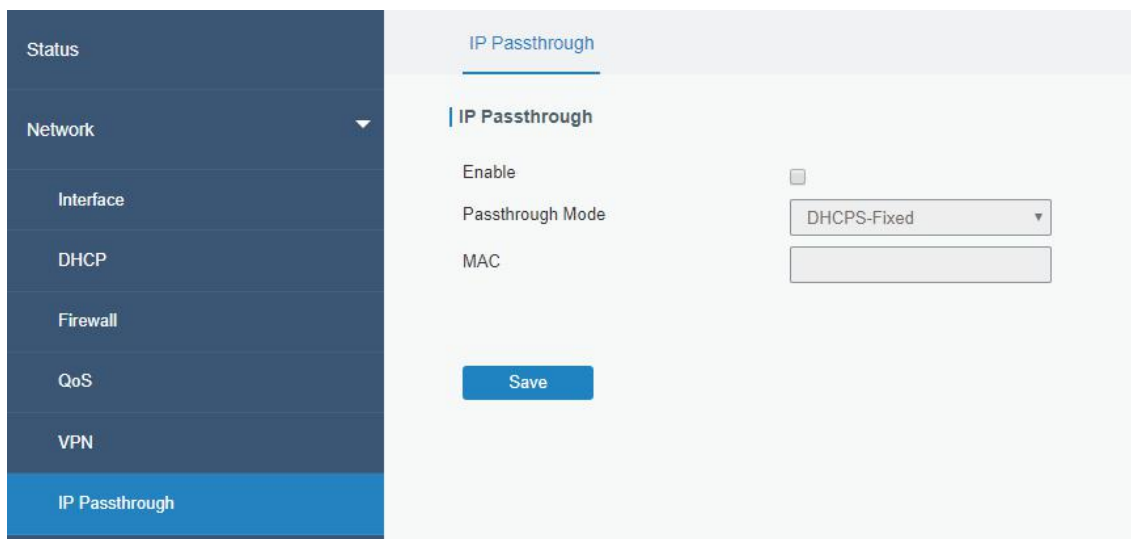

Figure 3-2-6-1

IP Passthrough	
Item	Description
Enable	Enable or disable IP Passthrough.

Passthrough Mode	Select passthrough mode from “DHCPs-Fixed” and “DHCPs-Dynamic”.
MAC	Set MAC address.

Table 3-2-6-1 IP Passthrough Parameters

3.2.7 Routing

3.2.7.1 Static Routing

A static routing is a manually configured routing entry. Information about the routing is manually entered rather than obtained from dynamic routing traffic. After setting static routing, the package for the specified destination will be forwarded to the path designated by user.

Destination	Netmask/Prefix Length	Interface	Gateway	Distance	Operation
2400:3200::1	128	Cellular	2408:844b:1a30:115a:b94b::	1	X
2001:4860:4860::8888	128	Cellular	2408:844b:1a30:115a:b94b::	1	X
::	0	Cellular	2408:844b:1a30:115a:b94b::	1	X
::	0		2408:844b:1a30:126:a02f6e::	1	X
0.0.0.0	0.0.0.0	WAN	192.168.22.1	1	X

Figure 3-2-7-1

Static Routing	
Item	Description
Destination	Enter the destination IPv4/IPv6 address.
Netmask/Prefix Length	Enter the subnet mask or prefix length of destination address.
Interface	The interface through which the data can reach the destination address.
Gateway	IPv4/IPv6 address of the next router that will be passed by before the input data reaches the destination address.
Distance	Priority, smaller value refers to higher priority. Range: 1-255.

Table 3-2-7-1 Static Routing Parameters

3.2.7.2 RIP

RIP is mainly designed for small networks. RIP uses Hop Count to measure the distance to the destination address, which is called Metric. In RIP, the hop count from the router to its directly connected network is 0 and the hop count of network to be reached through a router is 1 and so on. In order to limit the convergence time, the specified metric of RIP is an integer in the range of 0 - 15 and

the hop count larger than or equal to 16 is defined as infinity, which means that the destination network or host is unreachable. Because of this limitation, the RIP is not suitable for large-scale networks. To improve performance and prevent routing loops, RIP supports split horizon function. RIP also introduces routing obtained by other routing protocols.

Each router that runs RIP manages a routing database, which contains routing entries to reach all reachable destinations.

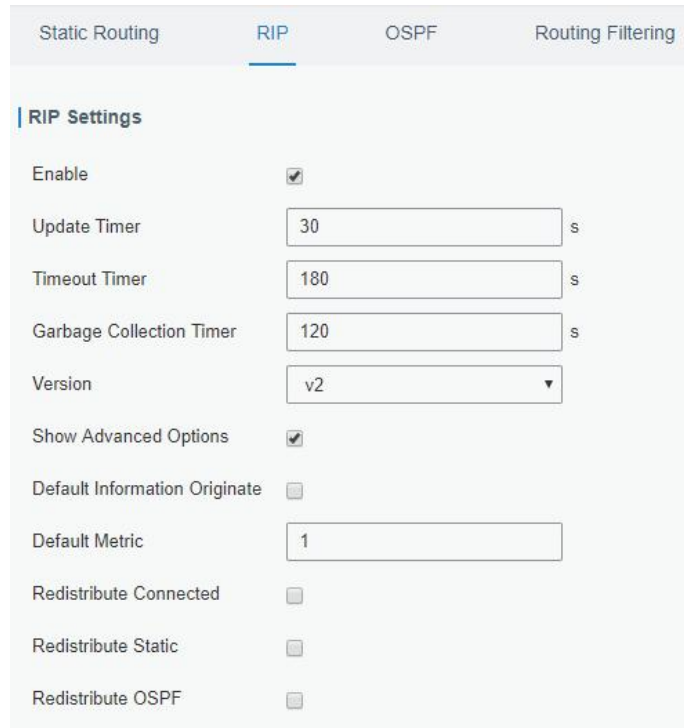

Item	Value
Enable	<input checked="" type="checkbox"/>
Update Timer	30 s
Timeout Timer	180 s
Garbage Collection Timer	120 s
Version	v2
Show Advanced Options	<input checked="" type="checkbox"/>
Default Information Originate	<input type="checkbox"/>
Default Metric	1
Redistribute Connected	<input type="checkbox"/>
Redistribute Static	<input type="checkbox"/>
Redistribute OSPF	<input type="checkbox"/>

Figure 3-2-7-2

RIP	
Item	Description
Enable	Enable or disable RIP.
Update Timer	It defines the interval to send routing updates. Range: 5-2147483647, in seconds.
Timeout Timer	It defines the routing aging time. If no update package on a routing is received within the aging time, the routing's Routing Cost in the routing table will be set to 16. Range: 5-2147483647, in seconds.
Garbage Collection Timer	It defines the period from the routing cost of a routing becomes 16 to it is deleted from the routing table. In the time of Garbage-Collection, RIP uses 16 as the routing cost for sending routing updates. If Garbage Collection times out and the routing still has not been updated, the routing will be completely removed from the routing table. Range: 5-2147483647, in seconds.
Version	RIP version. The options are v1 and v2.
Advanced Settings	

Default Information Originate	Default information will be released when this function is enabled.
Default Metric	The default cost for the router to reach destination. Range: 0-16
Redistribute Connected	Check to enable.
Metric	Set metric after "Redistribute Connected" is enabled. Range: 0-16.
Redistribute Static	Check to enable.
Metric	Set metric after "Redistribute Static" is enabled. Range: 0-16.
Redistribute OSPF	Check to enable.
Metric	Set metric after "Redistribute OSPF" is enabled. Range: 0-16.

Table 3-2-7-2 RIP Parameters

Distance/Metric Management							
Distance	IP Address	Netmask	ACL Name	Operation			
				+			
Metric	Policy In/Out	Interface	ACL Name	Operation			
				+			
Filter Policy							
Policy Type	Policy Name	Policy In/Out	Interface	Operation			
				+			
Passive Interface							
Passive Interface							Operation
							+
Interface							
Interface	Send Version	Receive Version	Split-Horizon	Authentication Mode	Authentication String	Authentication Key-chain	Operation
							+
Neighbor							
IP Address							Operation
							+
Network							
IP Address				Netmask			Operation
							+

Figure 3-2-7-3

Item	Description
Distance/Metric Management	
Distance	Set the administrative distance that a RIP route learns. Range: 1-255.
IP Address	Set the IP address of RIP route.
Netmask	Set the netmask of RIP route.
ACL Name	Set ACL name of RIP route.
Metric	The metric of received route or sent route from the interface. Range: 0-16.
Policy in/out	Select from "in" and "out".
Interface	Select interface of the route.
ACL Name	Access control list name of the route strategy.
Filter Policy	
Policy Type	Select from "access-list" and "prefix-list".
Policy Name	User-defined prefix-list name.
Policy in/out	Select from "in" and "out".
Interface	Select interface from "cellular0", "WAN" and "Bridge0".
Passive Interface	
Passive Interface	Select interface from "cellular0" and "WAN", "Bridge0".
Interface	
Interface	Select interface from "cellular0", "WAN" and "Bridge0".
Send Version	Select from "default", "v1" and "v2".
Receive Version	Select from "default", "v1" and "v2".
Split-Horizon	Select from "enable" and "disable".
Authentication Mode	Select from "text" and "md5".
Authentication String	The authentication key for package interaction in RIPV2.
Authentication Key-chain	The authentication key-chain for package interaction in RIPV2.
Neighbor	
IP Address	Set RIP neighbor's IP address manually.
Network	
IP Address	The IP address of interface for RIP publishing.
Netmask	The netmask of interface for RIP publishing.

Table 3-2-7-3

3.2.7.3 OSPF

OSPF, short for Open Shortest Path First, is a link status based on interior gateway protocol

developed by IETF.

If a router wants to run the OSPF protocol, there should be a Router ID that can be manually configured. If no Router ID configured, the system will automatically select an IP address of interface as the Router ID. The selection order is as follows:

- If a Loopback interface address is configured, then the last configured IP address of Loopback interface will be used as the Router ID;
- If no Loopback interface address is configured, the system will choose the interface with the biggest IP address as the Router ID.

Five types of packets of OSPF:

- **Hello packet**
- **DD packet** (Database Description Packet)
- **LSR packet** (Link-State Request Packet)
- **LSU packet** (Link-State Update Packet)
- **LSAck packet** (Link-Sate Acknowledgment Packet)

Neighbor and Neighboring

After OSPF router starts up, it will send out Hello Packets through the OSPF interface. Upon receipt of Hello packet, OSPF router will check the parameters defined in the packet. If it's consistent, a neighbor relationship will be formed. Not all matched sides in neighbor relationship can form the adjacency relationship. It is determined by the network type. Only when both sides successfully exchange DD packets and LSDB synchronization is achieved, the adjacency in the true sense can be formed. LSA describes the network topology around a router, LSDB describes entire network topology.

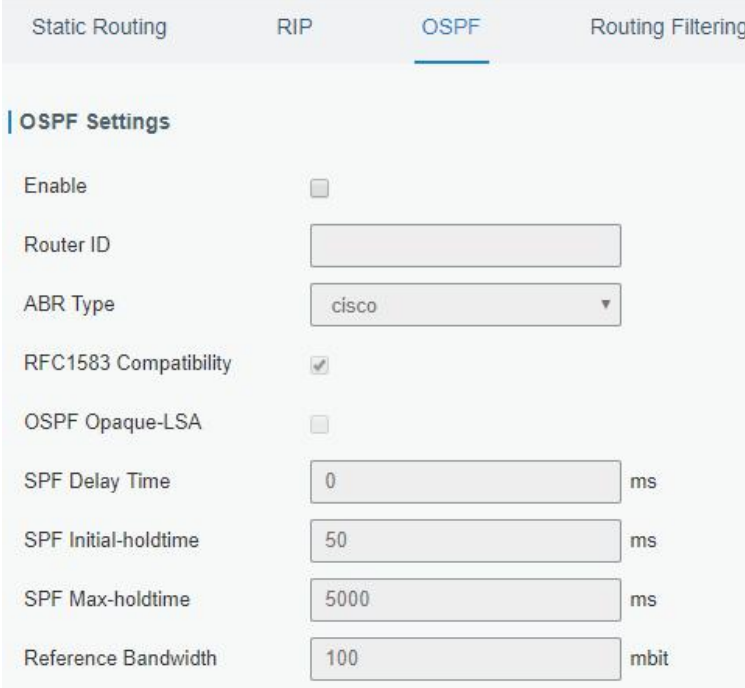

The screenshot shows a configuration interface for OSPF settings. At the top, there are four tabs: 'Static Routing', 'RIP', 'OSPF' (which is selected and underlined), and 'Routing Filtering'. Below the tabs, the 'OSPF Settings' section is visible. It contains several configuration options:

Setting	Value	Unit
Enable	<input type="checkbox"/>	
Router ID	<input type="text"/>	
ABR Type	cisco	
RFC1583 Compatibility	<input checked="" type="checkbox"/>	
OSPF Opaque-LSA	<input type="checkbox"/>	
SPF Delay Time	0	ms
SPF Initial-holdtime	50	ms
SPF Max-holdtime	5000	ms
Reference Bandwidth	100	mbit

Figure 3-2-7-4

OSPF	
Item	Description
Enable	Enable or disable OSPF.
Router ID	Router ID (IP address) of the originating LSA.
ABR Type	Select from cisco, ibm, standard and shortcut.
RFC1583 Compatibility	Enable/Disable.
OSPF Opaque-LSA	Enable/Disable LSA: a basic communication means of the OSPF routing protocol for the Internet Protocol (IP).
SPF Delay Time	Set the delay time for OSPF SPF calculations. Range: 0-6000000, in milliseconds.
SPF Initial-holdtime	Set the initialization time of OSPF SPF. Range: 0-6000000, in milliseconds.
SPF Max-holdtime	Set the maximum time of OSPF SPF. Range: 0-6000000, in milliseconds.
Reference Bandwidth	Range: 1-4294967, in Mbit.

Table 3-2-7-4 OSPF Parameters

Interface

Interface	Hello Interval(s)	Dead Interval(s)	Retransmit Interval(s)	Transmit Delay(s)	Operation
Bridge0	10	40	5	1	<input type="button" value="X"/>
					<input type="button" value="+"/>

Interface Advanced Options

Interface	Network	Cost	Priority	Authentication	Key ID	Key	Operation
Bridge	broad	10	1				<input type="button" value="X"/>
							<input type="button" value="+"/>

Figure 3-2-7-5

Item	Description
Interface	
Interface	Select interface from "cellular0","WAN"and "Bridge0".
Hello Interval (s)	Send interval of Hello packet. If the Hello time between two adjacent routers is different, the neighbour relationship cannot be established. Range: 1-65535.
Dead Interval (s)	Dead Time. If no Hello packet is received from the neighbours within the dead time, then the neighbour is considered failed. If dead times of two adjacent routers are different, the neighbour relationship cannot be established.
Retransmit Interval (s)	When the router notifies an LSA to its neighbour, it is required to make acknowledgement. If no acknowledgement packet is received within the

	retransmission interval, this LSA will be retransmitted to the neighbour. Range: 3-65535.
Transmit Delay (s)	It will take time to transmit OSPF packets on the link. So a certain delay time should be increased before transmission the aging time of LSA. This configuration needs to be further considered on the low-speed link. Range: 1-65535.
Interface Advanced Options	
Interface	Select interface.
Network	Select OSPF network type.
Cost	Set the cost of running OSPF on an interface. Range: 1-65535.
Priority	Set the OSPF priority of interface. Range: 0-255.
Authentication	Set the authentication mode that will be used by the OSPF area. Simple: a simple authentication password should be configured and confirmed again. MD5: MD5 key & password should be configured and confirmed again.
Key ID	It only takes effect when MD5 is selected. Range 1-255.
Key	The authentication key for OSPF packet interaction.

Table 3-2-7-5 OSPF Parameters

The screenshot shows a configuration interface with four main sections, each containing a table of fields and an 'Operation' column with a '+' button:

- Passive Interface:** A single table with columns 'Passive Interface' and 'Operation'.
- Network:** A table with columns 'IP Address', 'Netmask', 'Area ID', and 'Operation'.
- Neighbor:** A table with columns 'IP Address', 'Priority', 'Poll', and 'Operation'.
- Area:** A table with columns 'Area ID', 'Area', 'No Summary', 'Authentication', and 'Operation'.

Figure 3-2-7-6

Item	Description
Passive Interface	
Passive Interface	Select interface from "cellular0", "WAN" and "Bridge0".
Network	
IP Address	The IP address of local network.
Netmask	The netmask of local network.
Area ID	The area ID of original LSA's router.
Area	

Area ID	Set the ID of the OSPF area (IP address).
Area	Select from "Stub" and "NSSA". The backbone area (area ID 0.0.0.0) cannot be set as "Stub" or "NSSA".
No Summary	Forbid route summarization.
Authentication	Select authentication from "simple" and "md5".

Table 3-2--7-6 OSPF Parameters

Area Advanced Options

Area Range

Area ID	IP Address	Netmask	No Advertise	Cost	Operation
					+

Area Filter

Area ID	Filter Type	ACL Name	Operation
			+

Area Virtual Link

Area ID	ABR Address	Authentication	Key ID	Key	Hello Interval	Dead Interval	Retransmit Interval	Transmit Delay	Operation
									+



Figure 3-2-7-7

Area Advanced Options	
Item	Description
Area Range	
Area ID	The area ID of the interface when it runs OSPF (IP address).
IP Address	Set the IP address.
Netmask	Set the netmask.
No Advertise	Forbid the route information to be advertised among different areas.
Cost	Range: 0-16777215
Area Filter	
Area ID	Select an Area ID for Area Filter.
Filter Type	Select from "import", "export", "filter-in", and "filter-out".
ACL Name	Enter an ACL name which is set on "Routing > Routing Filtering" webpage.
Area Virtual Link	
Area ID	Set the ID number of OSPF area.
ABR Address	ABR is the router connected to multiple outer areas.
Authentication	Select from "simple" and "md5".
Key ID	It only takes effect when MD5 is selected. Range 1-15.
Key	The authentication key for OSPF packet interaction.
Hello Interval	Set the interval time for sending Hello packets through the interface. Range: 1-65535.

Dead Interval	The dead interval time for sending Hello packets through the interface. Range: 1-65535.
Retransmit Interval	The retransmission interval time for re-sending LSA. Range: 1-65535.
Transmit Delay	The delay time for LSA transmission. Range: 1-65535.

Table 3-2-7-7 OSPF Parameters

Redistribution

Redistribution Type	Metric	Metric Type	Route Map	Operation
connected		1		
				

Redistribution Advanced Options

Always Redistribute Default Route

Redistribute Default Route Metric

Redistribute Default Route Metric Type

Distance Management

Area Type	Distance	Operation
		

Figure 3-2-7-8

Item	Description
Redistribution	
Redistribution Type	Select from "connected", "static" and "rip".
Metric	The metric of redistribution router. Range: 0-16777214.
Metric Type	Select Metric type from "1" and "2".
Route Map	Mainly used to manage route for redistribution.
Redistribution Advanced Options	
Always Redistribute Default Route	Send redistribution default route after starting up.
Redistribute Default Route Metric	Send redistribution default route metric. Range: 0-16777214.
Redistribute Default Route Metric Type	Select from "0", "1" and "2".
Distance Management	
Area Type	Select from "intra-area", "inter-area" and "external".
Distance	Set the OSPF routing distance for area learning. Range: 1-255.

Table 3-2-7-8 OSPF Parameters

3.2.7.4 Routing Filtering

Figure 3-2-7-9

Routing Filtering	
Item	Description
Access Control List	
Name	User-defined name, need to start with a letter. Only letters, digits and underline (_) are allowed.
Action	Select from "permit" and "deny".
Match Any	No need to set IP address and subnet mask.
IP Address	User-defined.
Netmask	User-defined.
IP Prefix-List	
Name	User-defined name, need to start with a letter. Only letters, digits and underline (_) are allowed.
Sequence Number	A prefix name list can be matched with multiple rules. One rule is matched with one sequence number. Range: 1-4294967295.
Action	Select from "permit" and "deny".
Match Any	No need to set IP address, subnet mask, FE Length, and LE Length.
IP Address	User-defined.
Netmask	User-defined.
FE Length	Specify the minimum number of mask bits that must be matched. Range: 0-32.
LE Length	Specify the maximum number of mask bits that must be matched. Range: 0-32.

Table 3-2-7-9 Routing Filtering Parameters

3.2.8 VRRP

The Virtual Router Redundancy Protocol (VRRP) is a computer networking protocol that provides automatic assignment of available Internet Protocol (IP) routers for participating hosts. This increases the availability and reliability of routing paths via automatic default gateway selections in

an IP sub-network.

Increasing the number of exit gateway is a common method for improving system reliability. VRRP adds a group of routers that undertake gateway function into a backup group so as to form a virtual router. The election mechanism of VRRP will decide which router undertakes the forwarding task, and the host in LAN is only required to configure the default gateway for the virtual router.

In VRRP, routers need to be aware of failures in the virtual master router. To achieve this, the virtual master router sends out multicast “alive” announcements to the virtual backup routers in the same VRRP group.

The VRRP router who has the highest number will become the virtual master router. The VRRP router number ranges from 1 to 255 and usually we use 255 for the highest priority and 100 for backup.

If the current virtual master router receives an announcement from a group member (Router ID) with a higher priority, then the latter will pre-empt and become the virtual master router.

VRRP has the following characteristics:

- The virtual router with an IP address is known as the Virtual IP address. For the host in LAN, it is only required to know the IP address of virtual router, and set it as the address of the next hop of the default route.
- The network Host communicates with the external network through this virtual router.
- A router will be selected from the set of routers based on its priority to undertake the gateway function. Other routers will be used as backup routers to perform the duties of gateway for the gateway router in the case of any malfunction, so as to guarantee uninterrupted communication between the host and external network.

When interface connected with the uplink is at the state of Down or Removed, the router actively lowers its priority so that priority of other routers in the backup group will be higher. Thus the router with the highest priority becomes the gateway for the transmission task.

VRRP	
VRRP Status	
Status	DISABLE
VRRP Settings	
Enable	<input type="checkbox"/>
Interface	Bridge0
Virtual Router ID	1
Virtual IP	
Priority	100
Advertisement Interval (s)	1
Preemption Mode	<input type="checkbox"/>
IPv4 Primary Server	8.8.8.8
IPv4 Secondary Server	114.114.114.114
Interval	300 s
Retry Interval	5 s
Timeout	3 s
Max Ping Retries	3
Save	

Figure 3-2-8-1

VRRP		
Item	Description	Default
Enable	Enable or disable VRRP.	Disable
Interface	Select the interface of Virtual Router.	None
Virtual Router ID	User-defined Virtual Router ID. Range: 1-255.	None
Virtual IP	Set the IP address of Virtual Router.	None
Priority	The VRRP priority range is 1-254 (a bigger number indicates a higher priority). The router with higher priority will be more likely to become the gateway router.	100
Advertisement Interval (s)	Heartbeat package transmission time interval between routers in the virtual ip group. Range: 1-255.	1
Preemption Mode	If the router works in the preemption mode, once it finds that its own priority is higher than that of the current gateway router, it will send VRRP notification package, resulting in re-election of gateway router and eventually replacing the original gateway router. Accordingly, the original gateway router will become a Backup router.	Disable
IPV4 Primary Server	The router will send ICMP packet to the IP address or host name to determine whether the Internet connection is still available or not.	8.8.8.8
IPV4 Secondary Server	The router will try to ping the secondary server name if primary server is not available.	114.114.114.114
Interval	Time interval (in seconds) between two Pings.	300
Retry Interval	Set the ping retry interval. When ping failed, the router will ping again every retry interval.	5
Timeout	The maximum amount of time the router will wait for a response to a ping request. If it does not receive a response for the amount of time defined in this field, the ping request will be considered as failure.	3
Max Ping Retries	The retry times of the router sending ping request until determining that the connection has failed.	3

Table 3-2-8-1 VRRP Parameters

Related Configuration Example

[VRRP Application Example](#)

3.2.9 DDNS

Dynamic DNS (DDNS) is a method that automatically updates a name server in the Domain Name System, which allows user to alias a dynamic IP address to a static domain name.

DDNS serves as a client tool and needs to coordinate with DDNS server. Before starting configuration, user shall register on a website of proper domain name provider and apply for a domain name.

DDNS

| DDNS Status

Status -

| DDNS Method List

Enable

Name

Service Type DynDNS ▾

Username

User ID

Password

Server

Server Path

Hostname

Append IP

Use HTTPS

Save

Figure 3-2-9-1

DDNS	
Item	Description
Status	Show connection status of DDNS.
Enable	Enable/disable DDNS.
Name	Give the DDNS a descriptive name.
Service Type	Select the DDNS service provider.
Username	Enter the username for DDNS register.
User ID	Enter User ID of the custom DDNS server.
Password	Enter the password for DDNS register.
Server	Enter the name of DDNS server.
Server Path	By default the hostname is appended to the path.
Hostname	Enter the hostname for DDNS.
Append IP	Append your current IP to the DDNS server update path.

Use HTTPS	Enable HTTPS for some DDNS providers.
-----------	---------------------------------------

Table 3-2-9-1 DDNS Parameters

3.3 System

This section describes how to configure general settings, such as administration account, access service, system time, common user management, SNMP, AAA, event alarms, etc.

3.3.1 General Settings

3.3.1.1 General

General settings include system info and HTTPS certificates.

Figure 3-3-1-1

General		
Item	Description	Default
System		
Hostname	User-defined router name, needs to start with a letter.	ROUTER
Web Login Timeout (s)	You need to log in again if it times out. Range: 100-3600.	1800
Encrypting Cleartext Passwords	This function will encrypt all of cleartext passwords into ciphertext passwords.	Enable
HTTPS Certificates		
Certificate	Click "Browse" button, choose certificate file on the PC, and then click "Import" button to upload the file into router. Click "Export" button will export the file to the PC. Click "Delete" button will delete the file.	--
Key	Click "Browse" button, choose key file on the PC, and then	--

click "Import" button to upload the file into router. Click "Export" button will export file to the PC. Click "Delete" button will delete the file.

Table 3-3-1-1 General Setting Parameters

3.3.1.2 System Time

This section explains how to set the system time including time zone and time synchronization type.

Note: to ensure that the router runs with the correct time, it's recommended that you set the system time when configuring the router.

Figure 3-3-1-2

Figure 3-3-1-3

Figure 3-3-1-4

Figure 3-3-1-5

System Time	
Item	Description
Current Time	Show the current system time.
Time Zone	Click the drop down list to select the time zone you are in.
Sync Type	Click the drop down list to select the time synchronization type.
Sync with Browser	Synchronize time with browser.
Browser Time	Show the current time of browser.
Set up Manually	Manually configure the system time.
GPS Time Synchronization	Synchronize time with GPS.
Primary NTP Server	Enter primary NTP Server's IP address or domain name.
Secondary NTP Server	Enter secondary NTP Server's IP address or domain name.
NTP Server	

Enable NTP Server	NTP client on the network can achieve time synchronization with router after "Enable NTP Server" option is checked.
-------------------	---

Table 3-3-1-2 System Time Parameters

3.3.1.3 Email

SMTP, short for Simple Mail Transfer Protocol, is a TCP/IP protocol used in sending and receiving e-mail. This section describes how to configure email settings and add email groups for alarms and events.

Figure 3-3-1-6

SMTP Client Settings	
Item	Description
Enable	Enable or disable SMTP client function.
Email Address	Enter the sender's email account.
Password	Enter the sender's email password.
SMTP Server Address	Enter SMTP server's domain name.
Port	Enter SMTP server port. Range: 1-65535.
Encryption	Select from: None, TLS/SSL, STARTTLS. None: No encryption. The default port is 25. STARTTLS: STARTTLS is a way to take an existing insecure connection and upgrade it to a secure connection by using SSL/TLS. The default port is 587. TLS/SSL: SSL and TLS both provide a way to encrypt a communication channel between two computers (e.g. your computer and our server). TLS is the successor to SSL and the terms SSL and TLS are used interchangeably unless you're referring to a specific version of the protocol. The default port is 465.

Table 3-3-1-3 SMTP Setting

Figure 3-3-1-7

Item	Description
Email List	
Email Address	Enter the Email address.
Description	The description of the Email address.
Email Group List	
Group ID	Set number for email group. Range: 1-100.
Description	The description of the Email group.
List	Show the Email address list.
Selected	Show the selected Email address.

Table 3-3-1-4 Email Settings

Related Topics

[DI Setting](#)

[Events Setting](#)

[Events Application Example](#)

3.3.1.4 Storage

You can view SSD information on this page.

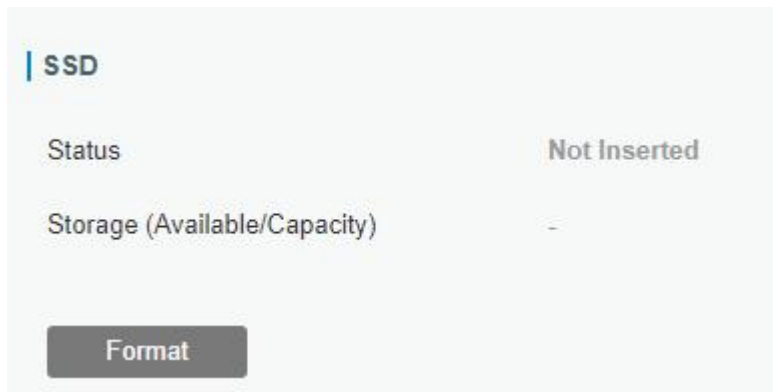

Figure 3-3-1-8

Storage	
Item	Description
Status	Show the status of SSD, such as "Available" or "Not Inserted".
Storage (Capacity/Available)	The total capacity of the SSD.
Format	Format the SSD.

Table 3-3-1-5 Storage Information

3.3.2 Phone&SMS

3.3.2.1 Phone

Phone settings involve in call/SMS trigger, SMS control and SMS alarm for events.

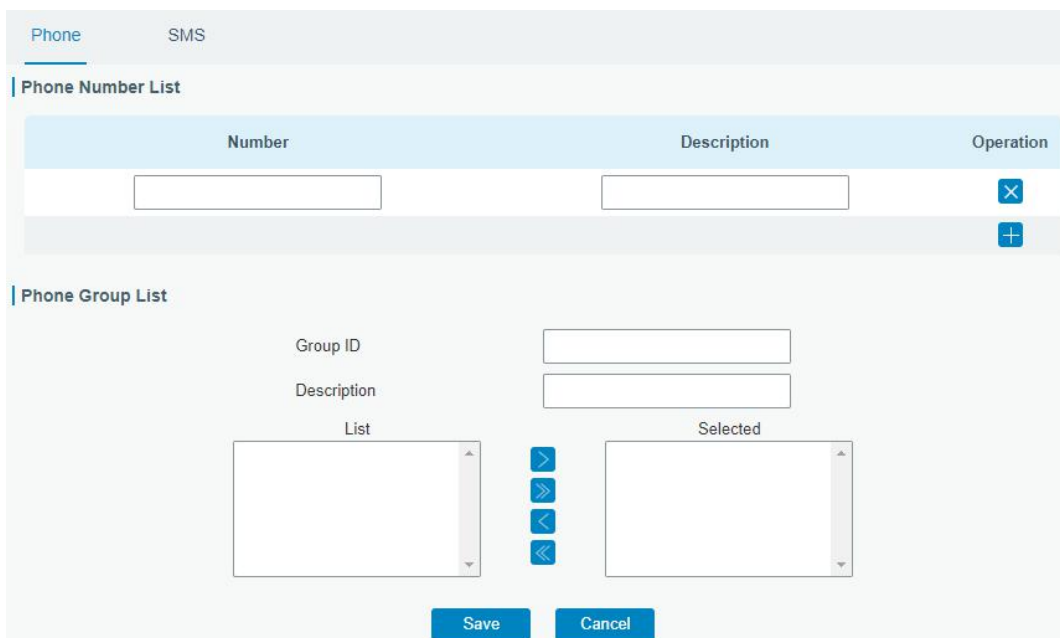

Figure 3-3-2-1

Phone	
Item	Description
Phone Number List	

Number	Enter the telephone number. Digits, "+" and "-" are allowed.
Description	The description of the telephone number.
Phone Group List	
Group ID	Set number for phone group. Range: 1-100.
Description	The description of the phone group.
List	Show the phone list.
Selected	Show the selected phone number.

Table 3-3-2-1 Phone Settings

Related Topic

[Connect on Demand](#)

3.3.2.2 SMS

SMS settings involve in remote SMS control, sending SMS and SMS receiving and sending status.

Figure 3-3-2-2

SMS Settings	
Item	Description
SMS Mode	Select SMS mode from "TEXT" and "PDU".
SMS Remote Control	Enable/disable SMS Remote Control.
Authentication Type	You can choose "phone number" or "password + phone number". Phone number: Use phone number for authentication. Password + phone number: Use both ""Password"" and ""Phone number"" for authentication.
Password	Set password for authentication.
Phone Group	Select the Phone group which used for remote control. User can click the Phone Group and set phone number.

Table 3-3-2-2 SMS Remote Control Parameters

Send SMS

Phone Number

Content

Inbox

From To Sender

Sender	Time	Content
--------	------	---------

< > 10 ▾ Go to:

Outbox

From To Recipient

Recipient	Time	Content	Status
-----------	------	---------	--------

< > 10 ▾ Go to:

Figure 3-3-2-3

SMS	
Item	Description
Send SMS	
Phone Number	Enter the number to receive the SMS.
Content	SMS content.
Inbox/Outbox	
Sender	SMS sender from outside.
Recipient	SMS recipient which UR75 send to.
From	Select the start date.
To	Select the end date.
Search	Search for SMS record.

Table 3-3-2-3 SMS Settings

3.3.3 User Management

3.3.3.1 Account

Here you can change the login username and password of the administrator.

Note: it is strongly recommended that you modify them for the sake of security.

Figure 3-3-3-1

Account	
Item	Description
Username	Enter a new username. You can use characters such as a-z, 0-9, "_", "-", "\$". The first character can't be a digit.
Old Password	Enter the old password.
New Password	Enter a new password.
Confirm New Password	Enter the new password again.

Table 3-3-3-1 Account Settings

3.3.3.2 User Management

This section describes how to create common user accounts.

The common user permission includes Read-Only and Read-Write.

Figure 3-3-3-2

User Management	
Item	Description
Username	Enter a new username. You can use characters such as a-z, 0-9, "_", "-", "\$". The first character can't be a digit.
Password	Set password.
Permission	Select user permission from "Read-Only" and "Read-Write". <ul style="list-style-type: none"> - Read-Only: users can only view the configuration of router in this level. - Read-Write: users can view and set the configuration of router in this level.

Table 3-3-3-2 User Management

3.3.4 SNMP

SNMP is widely used in network management for network monitoring. SNMP exposes management data with variables form in managed system. The system is organized in a management information base (MIB) which describes the system status and configuration. These variables can be remotely queried by managing applications.

Configuring SNMP in networking, NMS, and a management program of SNMP should be set up at the Manager.

Configuration steps are listed as below for achieving query from NMS:

1. Enable SNMP setting.
2. Download MIB file and load it into NMS.
3. Configure MIB View.
4. Configure VCAM.

Related Configuration Example

[SNMP Application Example](#)

3.3.4.1 SNMP

UR75 supports SNMPv1, SNMPv2c and SNMPv3 version. SNMPv1 and SNMPv2c employ community name authentication. SNMPv3 employs authentication encryption by username and password.

The screenshot shows a web configuration page for SNMP. At the top, there are five tabs: 'SNMP' (selected), 'MIB View', 'VACM', 'Trap', and 'MIB'. Below the tabs is a section titled 'SNMP Settings'. It contains five rows of configuration options:

- Enable:** A checkbox that is checked.
- Port:** A text input field containing the value '161'.
- SNMP Version:** A dropdown menu currently showing 'SNMPv2'.
- Location Information:** A text input field containing the value '225_location'.
- Contact Information:** A text input field containing the value '225_Contact'.

At the bottom of the settings area is a blue 'Save' button.

Figure 3-3-4-1

SNMP Settings	
Item	Description
Enable	Enable or disable SNMP function.
Port	Set SNMP listened port. Range: 1-65535. The default port is 161.
SNMP Version	Select SNMP version; support SNMP v1/v2c/v3.
Location Information	Fill in the location information.

Contact Information	Fill in the contact information.
---------------------	----------------------------------

Table 3-3-4-1 SNMP Parameters

3.3.4.2 MIB View

This section explains how to configure MIB view for the objects.

Figure 3-3-4-2

MIB View	
Item	Description
View Name	Set MIB view's name.
View Filter	Select from "Included" and "Excluded".
View OID	Enter the OID number.
Included	You can query all nodes within the specified MIB node.
Excluded	You can query all nodes except for the specified MIB node.

Table 3-3-4-2 MIB View Parameters

3.3.4.3 VACM

This section describes how to configure VACM parameters.

Figure 3-3-4-3

VACM	
Item	Description
SNMP v1 & v2 User List	
Community	Set the community name.
Permission	Select from "Read-Only" and "Read-Write".

MIB View	Select an MIB view to set permissions from the MIB view list.
Network	The IP address and bits of the external network accessing the MIB view.
Read-Write	The permission of the specified MIB node is read and write.
Read-Only	The permission of the specified MIB node is read only.
SNMP v3 User Group	
Group Name	Set the name of SNMPv3 group.
Security Level	Select from "NoAuth/NoPriv", "Auth/NoPriv", and "Auth/Priv".
Read-Only View	Select an MIB view to set permission as "Read-only" from the MIB view list.
Read-Write View	Select an MIB view to set permission as "Read-write" from the MIB view list.
Inform View	Select an MIB view to set permission as "Inform" from the MIB view list.
SNMP v3 User List	
Username	Set the name of SNMPv3 user.
Group Name	Select a user group to be configured from the user group.
Authentication	Select from "MD5", "SHA", and "None".
Authentication Password	The password should be filled in if authentication is "MD5" and "SHA".
Encryption	Select from "AES", "DES", and "None".
Encryption Password	The password should be filled in if encryption is "AES" and "DES".

Table 3-3-4-3 VACM Parameters

3.3.4.4 Trap

This section explains how to enable network monitoring by SNMP trap.

Figure 3-3-4

SNMP Trap	
Item	Description
Enable	Enable or disable SNMP Trap function.
SNMP Version	Select SNMP version; support SNMP v1/v2c/v3.
Server Address	Fill in NMS's IP address or domain name.
Port	Fill in UDP port. Port range is 1-65535. The default port is 162.

Name	Fill in the group name when using SNMP v1/v2c; fill in the username when using SNMP v3.
Auth/Priv Mode	Select from "NoAuth & No Priv", "Auth & NoPriv", and "Auth & Priv".

Table 3-3-4-4 Trap Parameters

3.3.4.5 MIB

This section describes how to download MIB files. The last MIB file "LTE-ROUTER-MIB.txt" is for the UR75 router.

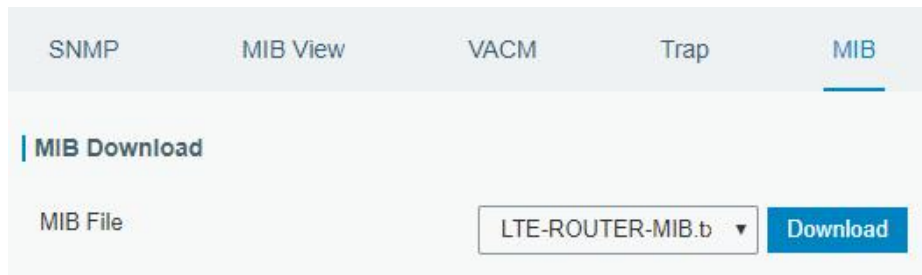

Figure 3-3-4-5

MIB	
Item	Description
MIB File	Select the MIB file you need.
Download	Click "Download" button to download the MIB file to PC.

Table 3-3-4-5 MIB Download

3.3.5 AAA

AAA access control is used for visitors control and the available corresponding services once access is allowed. It adopts the same method to configure three independent safety functions. It provides modularization methods for following services:

- Authentication: verify if the user is qualified to access to the network.
- Authorization: authorize related services available for the user.
- Charging: record the utilization of network resources.

3.3.5.1 Radius

Using UDP for its transport, Radius is generally applied in various network environments with higher requirements of security and permission of remote user access.

Figure 3-3-5-1

Radius	
Item	Description
Enable	Enable or disable Radius.
Server IP Address	Fill in the Radius server IP address/domain name.
Server Port	Fill in the Radius server port. Range: 1-65535.
Key	Fill in the key consistent with that of Radius server in order to get connected with Radius server.

Table 3-3-5-1 Radius Parameters

3.3.5.2 TACACS+

Using TCP for its transport, TACACS+ is mainly used for authentication, authorization and charging of the access users and terminal users by adopting PPP and VPDN.

Figure 3-3-5-2

TACACS+	
Item	Description
Enable	Enable or disable TACACS+.
Server IP Address	Fill in the TACACS+ server IP address/domain name.
Server Port	Fill in the TACACS+ server port. Range: 1-65535.
Key	Fill in the key consistent with that of TACACS+ server in order to get connected with TACACS+ server.

Table 3-3-5-2 TACACS+ Parameters

3.3.5.3 LDAP

A common usage of LDAP is to provide a central place to store usernames and passwords. This allows many different applications and services to connect the LDAP server to validate users.

LDAP is based on a simpler subset of the standards contained within the X.500 standard. Because of this relationship, LDAP is sometimes called X.500-lite as well.

Figure 3-3-5-3

LDAP	
Item	Description
Enable	Enable or Disable LDAP.
Server IP Address	Fill in the LDAP server's IP address/domain name. The maximum count is 10.
Server Port	Fill in the LDAP server's port. Range: 1-65535
Base DN	The top of LDAP directory tree.
Security	Select secure method from "None", "StartTLS" and "SSL".

Username	Enter the username to access the server.
Password	Enter the password to access the server.

Table 3-3-5-3 LDAP Parameters

3.3.5.4 Authentication

AAA supports the following authentication ways:

- None: uses no authentication, generally not recommended.
- Local: uses the local username database for authentication.
 - Advantages: rapidness, cost reduction.
 - Disadvantages: storage capacity limited by hardware.
- Remote: has user's information stored on authentication server. Radius, TACACS+ and LDAP supported for remote authentication.

When radius, TACACS+, and local are configured at the same time, the priority level is: 1 > 2 > 3.

Service	1	2	3
Console	None ▼	None ▼	None ▼
Web	None ▼	None ▼	None ▼
Telnet	None ▼	None ▼	None ▼
SSH	None ▼	None ▼	None ▼

Figure 3-3-5-4

Authentication	
Item	Description
Console	Select authentication for Console access.
Web	Select authentication for Web access.
Telnet	Select authentication for Telnet access.
SSH	Select authentication for SSH access.

Table 3-3-5-4 Authentication Parameters

3.3.6 Device Management

3.3.6.1 DeviceHub

You can connect the device to the Milesight DeviceHub on this page so as to manage the router centrally and remotely. For more details please refer to *DeviceHub User Guide*.

The screenshot shows a web interface for 'Milesight VPN'. At the top, there are two tabs: 'Device Management' (which is active) and 'Milesight VPN'. Below the tabs, the 'Device Management' section is displayed. It includes a 'Status' field showing 'Disconnected'. There are three input fields: 'Server Address', 'Authentication Code', and a dropdown menu for 'Activation Method' currently set to 'By Authentication Code'. A blue 'Connect' button is located at the bottom left of the form area.

Figure 3-3-6-1

DeviceHub	
Item	Description
Status	Show the connection status between the router and the DeviceHub.
Disconnected	Click this button to disconnect the router from the DeviceHub.
Server Address	IP address or domain of the device management server.
Activation Method	Select activation method to connect the router to the DeviceHub server, options are "By Authentication Code" and "By Account name".
Authentication Code	Fill in the authentication code generated from the DeviceHub.
Account name	Fill in the registered DeviceHub account (email) and password.
Password	

Table 3-3-6-1

3.3.6.2 Milesight VPN

You can connect the device to the Milesight VPN on this page so as to manage the router and connected devices centrally and remotely. For more details please refer to *MilesightVPN User Guide*.

Device Management
Milesight VPN

Milesight VPN Setting

Server	<input type="text"/>
Port	<input type="text" value="18443"/>
Authorization Code	<input type="text"/>
Device Name	<input type="text"/>

[Connect](#)

Milesight VPN Status

Status	Disconnected
Local IP	--
Remote IP	--
Duration	-

Figure 3-3-6-2

Milesight VPN	
Item	Description
Milesight VPN Settings	
Server	Enter the IP address or domain name of Milesight VPN.
Port	Enter the HTTPS port number.
Authorization code	Enter the authorization code which generated by Milesight VPN.
Device Name	Enter the name of the device.
Milesight VPN Status	
Status	Show the connection information about whether the router is connected to the Milesight VPN.
Local IP	Show the virtual IP of the router.
Remote IP	Show the virtual IP of the Milesight VPN.
Duration	Show the information on how long the router has been connected to the Milesight VPN.

Table 3-3-6-2

3.3.7 Events

Event feature is capable of sending alerts by Email when certain system events occur.

3.3.7.1 Events

You can view alarm messages on this page.

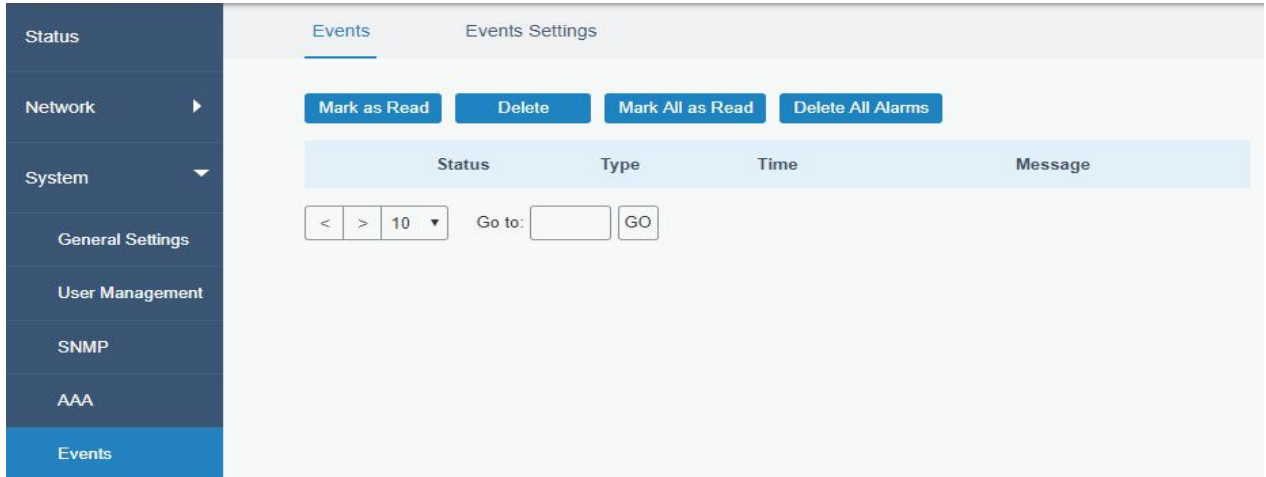

Figure 3-3-7-1

Events	
Item	Description
Mark as Read	Mark the selected event alarm as read.
Delete	Delete the selected event alarm.
Mark All as Read	Mark all event alarms as read.
Delete All Alarms	Delete all event alarms.
Status	Show the reading status of the event alarms, such as "Read" and "Unread".
Type	Show the event type that should be alarmed.
Time	Show the alarm time.
Message	Show the alarm content.

Table 3-3-7-1 Events Parameters

3.3.7.2 Events Settings

In this section, you can decide what events to record and whether you want to receive email and SMS notifications when any change occurs.

Events [Events Settings](#)

Events Settings

Enable

Phone Group List

Email Group List

Events	Record <input type="checkbox"/>	Email <input type="checkbox"/> Email Group List	SMS <input type="checkbox"/> Phone Group List	SNMP <input type="checkbox"/>
System Startup	<input type="checkbox"/>	<input type="checkbox"/>	<input type="checkbox"/>	<input type="checkbox"/>
System Reboot	<input type="checkbox"/>	<input type="checkbox"/>	<input checked="" type="checkbox"/>	<input checked="" type="checkbox"/>
System Time Update	<input type="checkbox"/>	<input type="checkbox"/>	<input checked="" type="checkbox"/>	<input checked="" type="checkbox"/>
VPN Up	<input type="checkbox"/>	<input type="checkbox"/>	<input type="checkbox"/>	<input type="checkbox"/>
VPN Down	<input type="checkbox"/>	<input type="checkbox"/>	<input type="checkbox"/>	<input type="checkbox"/>
WAN Up	<input type="checkbox"/>	<input type="checkbox"/>	<input type="checkbox"/>	<input type="checkbox"/>
WAN Down	<input type="checkbox"/>	<input type="checkbox"/>	<input type="checkbox"/>	<input type="checkbox"/>
Link switch	<input type="checkbox"/>	<input type="checkbox"/>	<input type="checkbox"/>	<input type="checkbox"/>
Weak Signal	<input type="checkbox"/>	<input type="checkbox"/>	<input type="checkbox"/>	<input type="checkbox"/>
Cellular Up	<input type="checkbox"/>	<input type="checkbox"/>	<input type="checkbox"/>	<input type="checkbox"/>

Figure 3-3-7-2

Cellular Down	<input checked="" type="checkbox"/>	<input type="checkbox"/>	<input type="checkbox"/>	<input type="checkbox"/>
Cellular Data Stats Clear	<input type="checkbox"/>	<input type="checkbox"/>	<input type="checkbox"/>	<input type="checkbox"/>
Cellular Data Traffic is running out	<input type="checkbox"/>	<input type="checkbox"/>	<input type="checkbox"/>	<input type="checkbox"/>
Cellular Data Traffic Overflow	<input type="checkbox"/>	<input type="checkbox"/>	<input type="checkbox"/>	<input type="checkbox"/>
WLAN Up(AP)	<input type="checkbox"/>	<input type="checkbox"/>	<input type="checkbox"/>	<input type="checkbox"/>
WLAN Down(AP)	<input type="checkbox"/>	<input type="checkbox"/>	<input type="checkbox"/>	<input type="checkbox"/>
WLAN Up(Client)	<input type="checkbox"/>	<input type="checkbox"/>	<input type="checkbox"/>	<input type="checkbox"/>
WLAN Down(Client)	<input type="checkbox"/>	<input type="checkbox"/>	<input type="checkbox"/>	<input type="checkbox"/>

Figure 3-3-7-3

Event Settings	
Item	Description
Enable	Check to enable "Events Settings".
Phone Group List	Select phone group to receive SMS alarm.
Email Group List	Select email group to receive alarm.
Record	The relevant content of event alarm will be recorded on "Event" page if this option is checked.
Email	The relevant content of event alarm will be sent out via email if this option is checked.

Email Setting	Click and you will be redirected to the page "Email" to configure email group list.
SMS	The relevant content of event alarm will be sent out via SMS if this option is checked.
SMS Setting	Click and you will be redirected to the page of "Phone" to configure phone group list.
VPN Up	VPN is connected.
VPN Down	VPN is disconnected.
WAN Up	Ethernet cable is connected to WAN port.
WAN Down	Ethernet cable is disconnected to WAN port.
Link Switch	Switch to use other interface for Internet access.
Weak Signal	The signal level of cellular is low.
Cellular Up	Cellular network is connected.
Cellular Down	Cellular network is disconnected.
Cellular Data Stats Clear	Zero out the data usage of the main SIM card.
Cellular Data Traffic is running out	The main SIM card is reaching the data usage limit.
Cellular Data Traffic Over Flow	The main SIM card has exceeded the data usage plan.
WLAN Up(AP)	The WLAN(AP) is enabled.
WLAN Down(AP)	The WLAN(AP) has stopped working.
WLAN Up(Client)	The WLAN(Client) is enabled.
WLAN Down(Client)	The WLAN(Client) has stopped working.

Table 4-3-7-2 Events Parameters

Related Topics

[Email Setting](#)

[Events Application Example](#)

3.4 Industrial Interface

UR75 router is capable of connecting with terminals through industrial interfaces so as to realize wireless communication between terminals and remote data center.

There are two types of the router's industrial interface: serial port (RS232 and RS485) and I/O (digital input and digital output).

RS232 adopts full-duplex communication. It's generally used for communication within 20m.

RS485 adopts half-duplex communication to achieve transmission of serial communication data with distance up to 120m.

Digital input of I/O interface is a logical variable or switch variable with only two values of 0 and 1. "0" refers to low level and "1" refers to high level .

3.4.1 I/O

3.4.1.1 DI

This section explains how to configure monitoring condition on digital input, and take certain actions once the condition is reached.

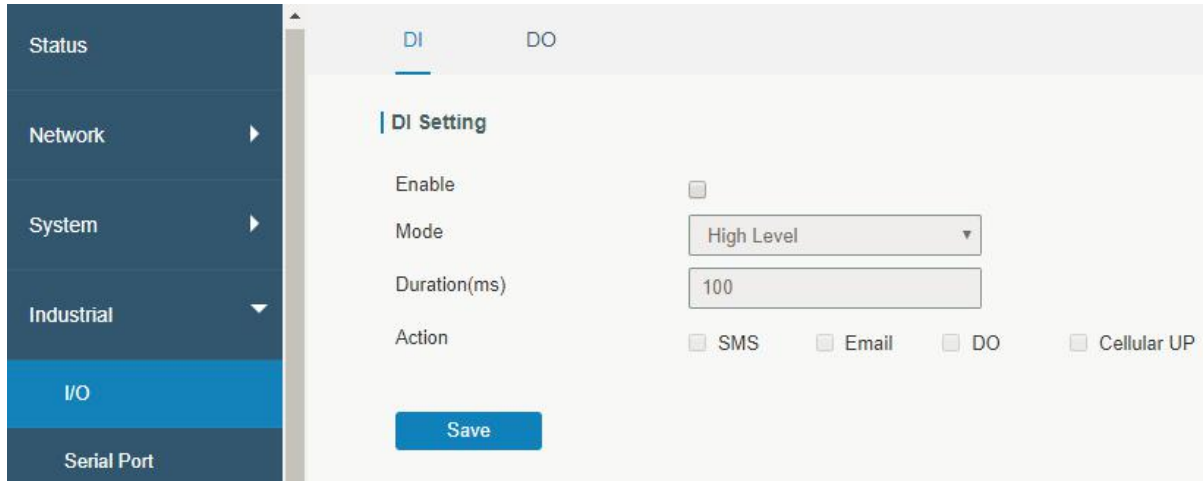

Figure 3-4-1-1

DI	
Item	Description
Enable	Enable or disable DI.
Mode	Options are "High Level", "Low Level", and "Counter".
Duration (ms)	Set the duration of high/low level in digital input. Range: 1-10000.
Condition	Select from "Low->High", and "High-> Low".
Low->High	The counter value will increase by 1 if digital input's status changes from low level to high level.
High->Low	The counter value will increase by 1 if digital input's status changes from high level to low level.
Counter	The system will take actions accordingly when the counter value reach the preset one, and then reset the counter value to 0. Range: 1-100.
Action	Select the corresponding actions that the system will take when digital input mode meets the preset condition or duration.
SMS	Check to enable SMS alarm.
Phone Group	Set phone group to receive SMS alarm.
SMS Content	Set the content of SMS alarm.
Email	Check to enable Email alarm.
Email Group	Set phone group to receive email alarm.
Email Content	Set the content of email alarm.
DO	Control output status of DO.
Cellular UP	Trigger the router to switch from offline mode to cellular network mode.

Table 3-4-1-1 DI Parameters

Related Topics

[DO Setting](#)

[Email Setting](#)

[Connect on Demand](#)

3.4.1.2 DO

This section describes how to configure digital output mode.

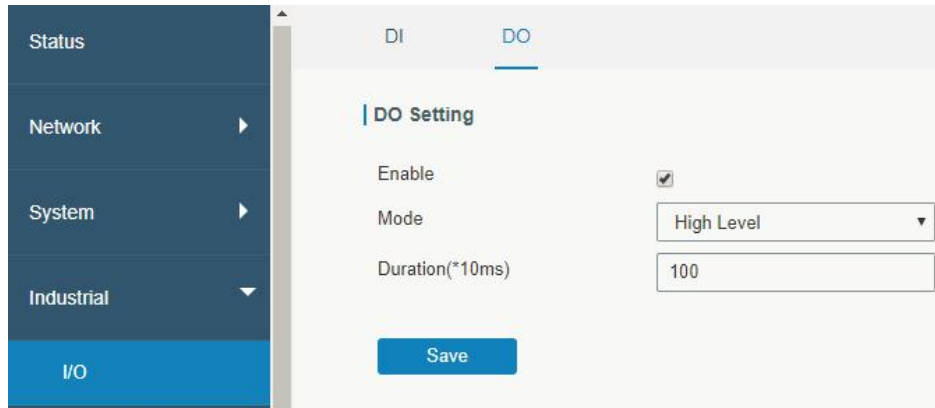

Figure 3-4-1-2

DO	
Item	Description
Enable	Enable or disable DO.
Mode	Select from "High Level", "Low Level", "Pulse" and "Custom" .
Duration (*10ms)	Set duration of high/low level on digital output. Range: 1-10000.
Initial Status	Select high level or low level as the initial status of the pulse.
Duration of High Level (*10ms)	Set the duration of pulse's high level. Range: 1-10000.
Duration of Low Level (*10ms)	Set the duration of pulse's low level. Range: 1-10000.
The Number of Pulse	Set the quantity of pulse. Range: 1-100.
Phone Group	Select phone group which will be used for I/O configuration. User can click the Phone Group and set phone number.

Table 3-4-1-2 DO Settings

Related Topics

[DI Setting](#)

3.4.2 Serial Port

This section explains how to configure serial port parameters to achieve communication with serial terminals, and configure work mode to achieve communication with the remote data center, so as to achieve two-way communication between serial terminals and remote data center.

Serial1
Serial 2

Serial Settings

Enable

Serial Type RS232 ▼

Baud Rate 9600 ▼

Data Bits 8bits ▼

Stop Bits 1bits ▼

Parity None ▼

Software Flow Control

Serial Mode Modbus Master ▼

Save & Apply

Figure 3-4-2-1

Serial Settings		
Item	Description	Default
Enable	Enable or disable serial port function.	Disable
Serial Type	Serial Port 1 is a RS232 port and Serial Port 2 is a RS485 port.	--
Baud Rate	Range is 300-230400. Same with the baud rate of the connected terminal device.	9600
Data Bits	Options are "8" and "7". Same with the data bits of the connected terminal device.	8
Stop Bits	Options are "1" and "2". Same with the stop bits of the connected terminal device.	1
Parity	Options are "None", "Odd" and "Even". Same with the parity of the connected terminal device.	None
Software Flow Control	Enable or disable software flow control.	Disable
Serial Mode	Select work mode of the serial port. Options are "DTU Mode", "Modbus Master", "Modbus Slave" and "GPS".	Disable
DTU Mode	In DTU mode, the serial port can establish communication with the remote server/client.	--
GPS	In GPS mode, go to "Industrial > GPS > GPS Serial Forwarding" to select corresponding Serial Type, then GPS data will be forwarded to this serial port.	--
Modbus Master	In Modbus Master mode, go to "Industrial > Modbus Master" to configure basic parameters and channels.	--
Modbus Slave	In Modbus Slave mode, go to "Industrial > Modbus Slave" to	--

configure basic parameters.

Table 3-4-2-1 Serial Parameters

Serial Mode: DTU Mode

DTU Protocol: Transparent

Protocol: TCP

Keepalive Interval: 75 s

Keepalive Retry Times: 9

Packet Size: 1024 Bytes

Serial Frame Interval: 100 ms

Reconnect Interval: 10 s

Specific Protocol:

Register String:

Destination IP Address

Server Address	Server Port	Status	Operation
			+

Figure 3-4-2-2

DTU Mode		
Item	Description	Default
DTU Protocol	<p>Select from "None", "Transparent", "Modbus", "UDP server" and "TCP server".</p> <ul style="list-style-type: none"> - Transparent: the routed is used as TCP client/UDP and transmits data transparently. - TCP server: the router is used as TCP server and transmits data transparently. - UDP server: the router is used as UDP server and transmits data transparently. - Modbus: the router will be used as TCP server with modbus gateway function, which can achieve conversion between Modbus RTU and Modbus TCP. 	--
TCP/UDP Server		
Listening port	Set the router listening port. Range: 1-65535.	502
Keepalive Interval	After TCP connection is established, client will send heartbeat packet regularly by TCP to keep alive. The interval range is 1-3600 in seconds.	75
Keepalive Retry Times	When TCP heartbeat times out, router will resend heartbeat. After it reaches the preset retry times, TCP connection will be reestablished. The retry times range is 1-16.	9
Packet Size	Set the size of the serial data frame. Packet will be sent out when preset frame size is reached. The size range is 1-1024. The unit is	1024

	byte.	
Serial Frame Interval	The interval that the router sends out real serial data stored in the buffer area to public network. The range is 10-65535, in milliseconds. Note: data will be sent out to public network when real serial data size reaches the preset packet size, even though it's within the serial frame interval.	100

Table 3-4-2-2 DTU Parameters

Item	Description	Default
Transparent		
Protocol	Select "TCP" or "UDP" protocol.	TCP
Keepalive Interval (s)	After TCP client is connected with TCP server, the client will send heartbeat packet by TCP regularly to keep alive. The interval range is 1-3600, in seconds.	75
Keepalive Retry Times	When TCP heartbeat times out, the router will resend heartbeat. After it reaches the preset retry times, router will reconnect to TCP server. The range is 1-16.	9
Packet Size	Set the size of the serial data frame. Packet will be sent out when preset frame size is reached. The range is 1-1024. The unit is byte.	1024
Serial Frame Interval	The interval that the router sends out real serial data stored in the buffer area to public network. The range is 10-65535, in milliseconds. Note: data will be sent out to public network when real serial data size reaches the preset packet size, even though it's within the serial frame interval.	100
Reconnect Interval	After connection failure, router will reconnect to the server at the preset interval, in seconds. The range is 10-60.	10
Specific Protocol	By Specific Protocol, the router will be able to connect to the TCP2COM software.	--
Heartbeat Interval	By Specific Protocol, the router will send heartbeat packet to the server regularly to keep alive. The interval range is 1-3600, in seconds.	30
ID	Define unique ID of each router. No longer than 63 characters without space character.	--
Register String	Define register string for connection with the server.	Null
Server Address	Fill in the TCP or UDP server address (IP/domain name).	Null
Server Port	Fill in the TCP or UDP server port. Range: 1-65535.	Null
Status	Show the connection status between the router and the server.	--
Modbus		
Local Port	Set the router listening port. Range: 1-65535.	502
Maximum TCP Clients	Specify the maximum number of TCP clients allowed to connect the router which act as a TCP server.	32
Connection	If the TCP server does not receive any data from the slave device w	60

Timeout	within the connection timeout period, the TCP connection will be broken.	
Reading Interval	Set the interval for reading remote channels. When a read cycle ends, the new read cycle begins until this interval expires. If it is set to 0, the device will restart the new read cycle after all channels have been read.	100
Response Timeout	Set the maximum response time that the router waits for the response to the command. If the device does not get a response after the maximum response time, it's determined that the command has timed out.	3000
Maximum Retries	Set the maximum retry times after it fails to read.	3

Table 3-4-2-3 DTU Parameters

Related Configuration Example

[DTU Application Example](#)

3.4.3 Modbus Slave

This section describes how to achieve I/O status via Modbus TCP, Modbus RTU and Modbus RTU over TCP.

3.4.3.1 Modbus TCP

You can define the address of the DI and DO ports so as to poll DI's status and control DO's status via Modbus TCP protocol.

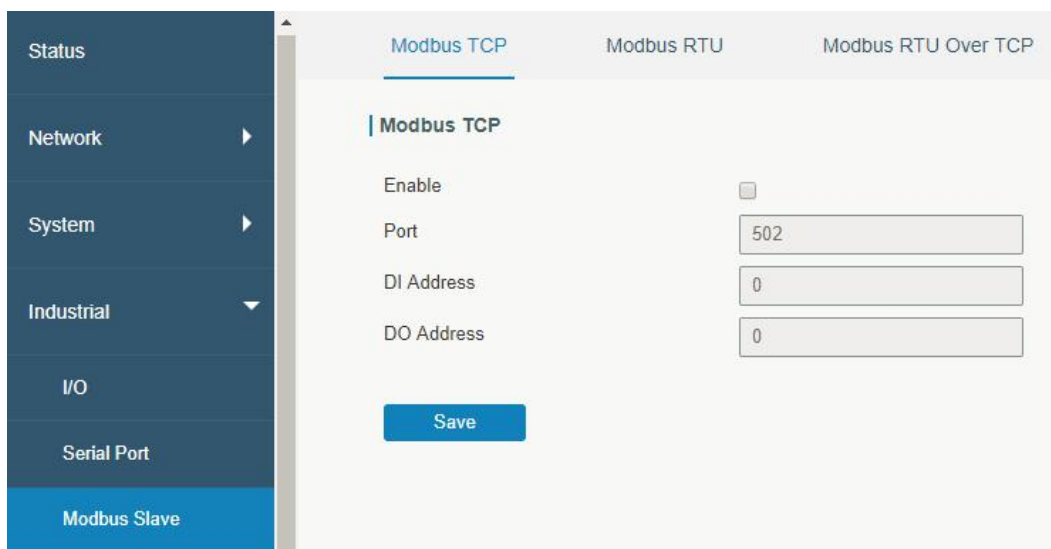

Figure 3-4-3-1

Modbus TCP		
Item	Description	Default
Enable	Enable/disable Modbus TCP.	Disable
Port	Set the router listening port. Range: 1-65535.	502
DI Address	Define the address of DI, range: 0-255.	0

DO Address	Define the address of DO, range: 0, 2-255.	0
------------	--	---

Table 3-4-3-1 Modbus TCP Parameters

3.4.3.2 Modbus RTU

You can define the address of the DI and DO ports so as to poll DI's status and control DO's status via Modbus RTU protocol.

Figure 3-4-3-2

Modbus RTU		
Item	Description	Default
Enable	Enable/disable Modbus RTU.	Disable
Serial Port	Select the corresponding serial port.	serial
Slave ID	Set slave ID is used for distinguishing different devices on the same link.	1
DI Address	Define the address of DI, range: 0-255.	0
DO Address	Define the address of DO, range: 0, 2-255.	0

Table 3-4-3-2 Modbus RTU Parameters

3.4.3.3 Modbus RTU Over TCP

You can define the address of the DI and DO ports so as to poll DI's status and control DO's status via Modbus RTU over TCP.

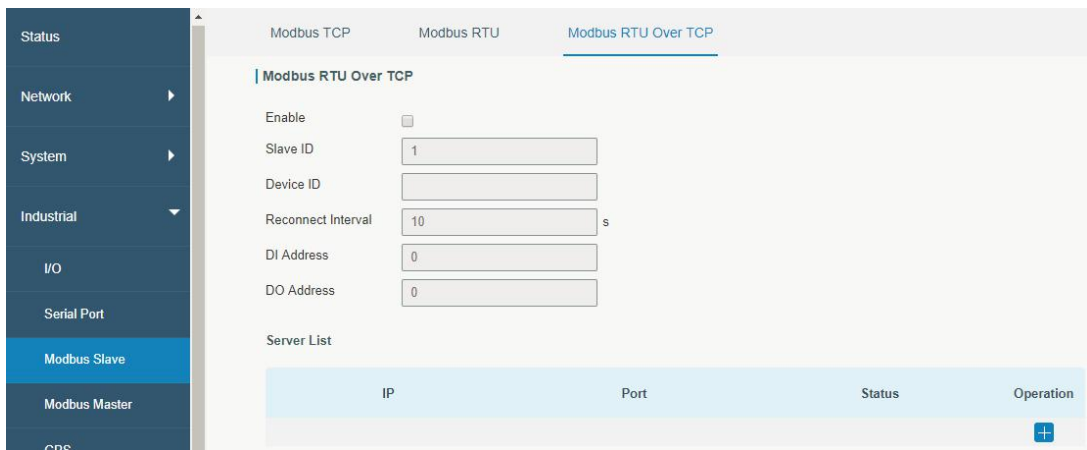

Figure 3-4-3-3

Modbus RTU Over TCP		
Item	Description	Default
Enable	Enable/disable Modbus RTU over TCP function.	Disable
Slave ID	Set slave ID is used for distinguishing different devices on the same link.	1
Device ID	Set device ID. The server will get the device ID to the server for identifying identity so that the server can manage multiple devices.	--
Reconnection Interval	The reconnection interval when the device and the server fails to establish connection or disconnected.	10
DI Address	Define the address of DI, range: 0-255.	0
DO Address	Define the address of DO, range: 0, 2-255.	0
Server List		
IP	Enter the IP address of the server.	
Port	Enter the port of the server. Range: 0-65535.	
Status	Show the connection status between the router and the server.	

Table 3-4-3-3 Modbus RTU Over TCP Parameters

3.4.4 Modbus Master

UR75 router can be set as Modbus Master to poll the remote Modbus Slave and send alarm according to the response.

3.4.4.1 Modbus Master

You can configure Modbus Master's parameters on this page.

Figure 3-4-4-1

Modbus Master		
Item	Description	Default
Enable	Enable/disable Modbus master.	--
Read Interval/s	Set the interval for reading remote channels. When the read cycle ends, the commands which haven't been sent out will be discard, and the new read cycle begins. If it is set to 0, the device will restart the new read cycle after all channels have been read. Range: 0-600.	0
Max. Retries	Set the maximum retry times after it fails to read, range: 0-5.	3
Max. Response Time/ms	Set the maximum response time that the router waits for the response to the command. If the device does not get a response after the maximum response time, it's determined that the command has timed out. Range: 10-1000.	500
Execution Interval/ms	The execution interval between each command. Range: 10-1000.	50
Channel Name	Select a readable channel form the channel list.	--

Table 3-4-4-1

3.4.4.2 Channel

You can add the channels and configure alarm setting on this page, so as to connect the router to the remote Modbus Slave to poll the address on this page and receive alarms from the router in different conditions.

Figure 3-4-4-2

Channel Setting	
Item	Description
Name	Set the name to identify the remote channel. It cannot be blank.
Slave ID	Set Modbus slave ID.
Address	The starting address for reading.
Number	The address number for reading.
Type	Read command, options are "Coil", "Discrete", "Holding Register (INT16)", "Input Register (INT16)", "Holding Register (INT32)" and "Holding Register (Float)".
Link	Select TCP for transportation.
IP address	Fill in the IP address of the remote Modbus device.
Port	Fill in the port of the remote Modbus device.
Sign	To identify whether this channel is signed. Default: Unsigned.
Decimal Place	Used to indicate a dot in the read into the position of the channel. For example: read the channel value is 1234, and a Decimal Place is equal to 2, then the actual value is 12.34.

Table 3-4-4-2

Figure 3-4-4-3

Alarm Setting	
Item	Description
Name	Set the same name with the channel name to identify the remote channel.
Condition	The condition that triggers alert.
Min. Threshold	Set the min. value to trigger the alert. When the actual value is less than this value, the alarm will be triggered.
Max. Threshold	Set the max. value to trigger the alert. When the actual value is more than this value, the alarm will be triggered.
Alarm	Select the alarm method, e.g SMS.
SMS	The preset alarm content will be sent to the specified phone number.
Phone Group	Select the phone group to receive the alarm SMS.
Email Group	Select the Email group to receive the alarm Email.
Normal Content	When the actual value is restored to the normal value from exceeding the threshold value, the router will automatically cancel the abnormal alarm and send the preset normal content to the specified phone group.
Abnormal Content	When the actual value exceeds the preset threshold, the router will automatically trigger the alarm and send the preset abnormal content to the specified phone group.
Continuous Alarm	Once it is enabled, the same alarm will be continuously reported. Otherwise, the same alarm will be reported only one time.

Table 3-4-4-3

TCP Forwarding

Name	IP	Port	Operation
All ▼	<input type="text"/>	<input type="text"/>	✕ +

Figure 3-4-4-4

TCP Forwarding	
Item	Description
Name	The name of Modbus Master's channel.
IP	The IP address of the server which the packets are forwarded to.
Port	The port of the server's which the packets are forwarded to.

Table 3-4-4-4

3.4.5 GPS

This section give you a detailed introduction to GPS settings, including GPS IP forwarding and GPS serial forwarding.

3.4.5.1 GPS

When you want to receive GPS data, you should enable GPS function on this page.

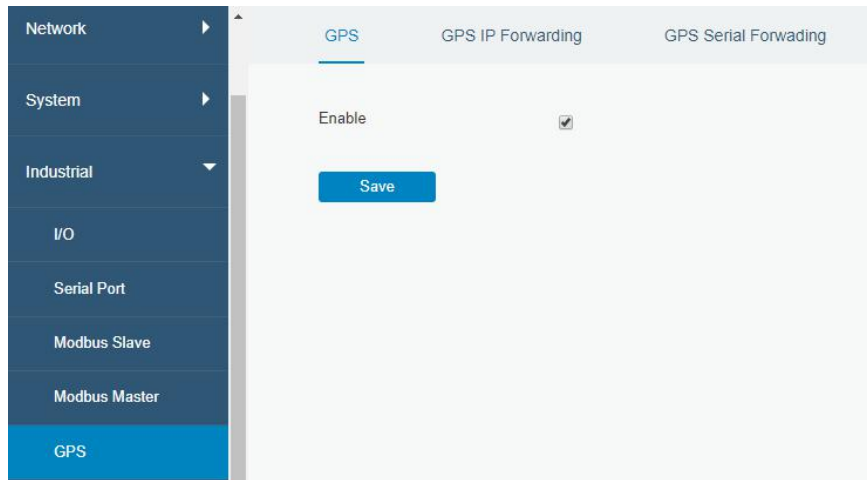

Figure 3-4-5-1

3.4.5.2 GPS IP Forwarding

GPS IP forwarding means that GPS data can be forwarded over the Internet.

Figure 3-4-5-2

Destination IP Address			
Server Address	Server Port	Status	Operation
			+

Figure 3-4-5-3

GPS IP Forwarding		
Item	Description	Default
Enable	Forward the GPS data to the client or server.	Disable
Type	Select connection type of the router. The options are "Client" and "Server".	Client
Protocol	Select protocol of data transmission. The options are "TCP" and "UDP".	TCP
Keepalive Interval	After it's connected with server/client, the router will send heartbeat packet regularly to the server/client to keep alive. The interval range is 1-3600, in seconds.	75
Keepalive Retry	When TCP heartbeat times out, the router will resend heartbeat. After it reaches the preset retry times, router will reconnect to TCP server. The range is 1-16.	9
Local Port	Set the router listening port. Range: 1-65535.	
Reconnect Interval	After connection failure, router will reconnect to the server at the preset interval, in seconds. The range is 10-60.	10
Report Interval	Router will send GPS data to the server/client at the preset interval, in seconds. The range is 1-60.	30
Include RMC	Whether include RMC in GPS data.	--
Include GSA	Whether include GSA in GPS data.	--
Include GGA	Whether include GGA in GPS data.	--
Include GSV	Whether include GSV in GPS data.	--
Message Prefix	Add a prefix to the GPS data.	Null
Message Suffix	Add a suffix to the GPS data.	Null
Destination IP Address		
Server Address	Fill in the server address to receive GPS data (IP/domain name).	--
Server Port	Fill in the port to receive GPS data. Range: 1-65535.	--
Status	Show the connection status between the router and the server.	--

Table 3-4-5-1 GPS IP Forwarding Parameters

3.4.5.3 GPS Serial Forwarding

GPS IP forwarding means that GPS data can be forwarded to the serial port.

Figure 3-4-5-4

GPS Serial Forwarding		
Item	Description	Default
Enable	Forward the GPS data to the preset serial port.	Disable
Serial Type	Select the serial port to receive GPS data.	Serial1
Report Interval	Router will forward the GPS data to the serial port at the preset interval, in seconds. The range is 1-60.	30
Include RMC	Whether include RMC in GPS data.	--
Include GSA	Whether include GSA in GPS data.	--
Include GGA	Whether include GGA in GPS data.	--
Include GSV	Whether include GSV in GPS data.	--

Table 3-4-5-2 GPS Serial Forwarding Parameters

3.5 Maintenance

This section describes system maintenance tools and management.

3.5.1 Tools

Troubleshooting tools includes ping, traceroute, packet analyzer and qxdmlog.

3.5.1.1 Ping

Ping tool is engineered to ping outer network.

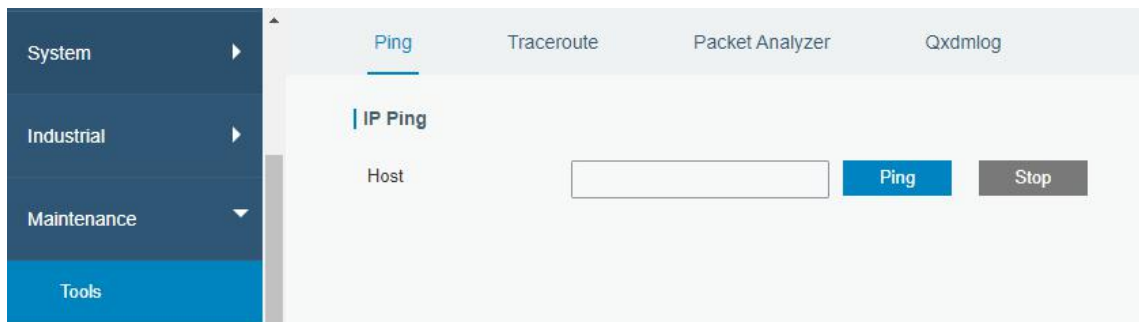

Figure 3-5-1-1

PING	
Item	Description
Host	Ping outer network from the router.

Table 3-5-1-1 IP Ping Parameters

3.5.1.2 Traceroute

Traceroute tool is used for troubleshooting network routing failures.

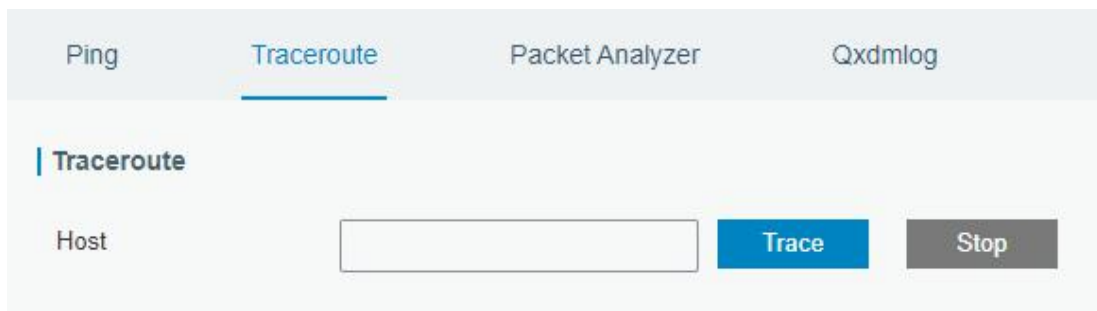

Figure 3-5-1-2

Traceroute	
Item	Description
Host	Address of the destination host to be detected.

Table 3-5-1-2 Traceroute Parameters

3.5.1.3 Packet Analyzer

Packet Analyzer is used for capturing the packet of different interfaces.

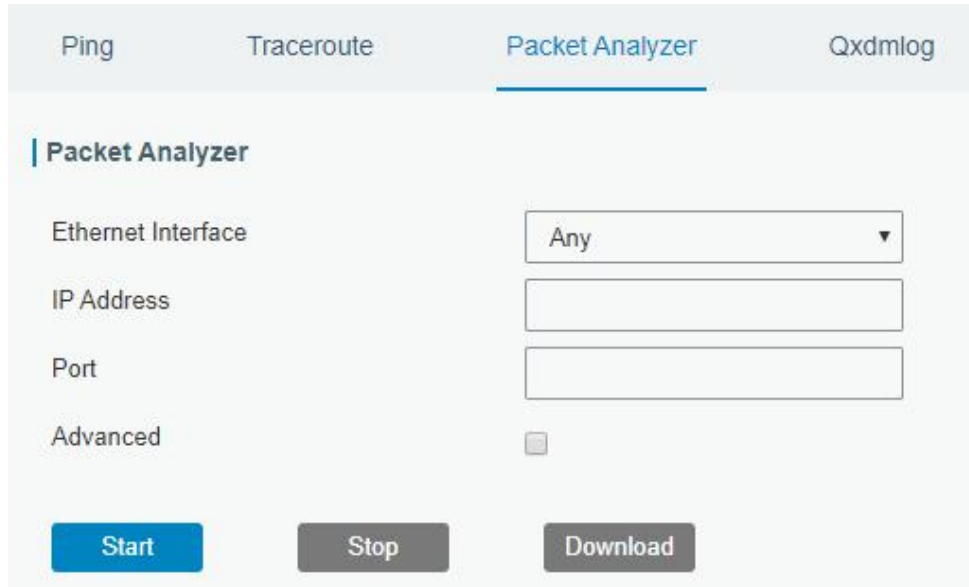

Figure 3-5-1-3

Packet Analyzer	
Item	Description
Ethernet Interface	Select the interface to capture packages.
IP Address	Set the IP address that the router will capture.
Port	Set the port that the router will capture.
Advanced	Set the rules for sniffer. The format is tcpdump.

Table 3-5-1-3 Packet Analyzer Parameters

3.5.1.4 Qxdmlog

This section allow collecting diagnostic logs via QXDM tool.

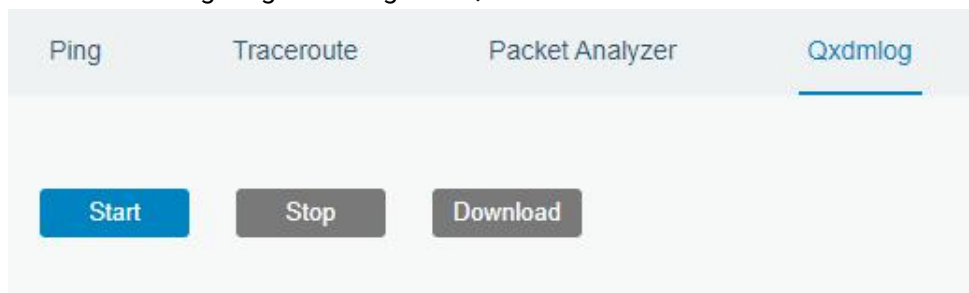

Figure 3-5-1-4

3.5.2 Debugger

3.5.2.1 Cellular Debugger

This section explains how to send AT commands to router and check cellular debug information.

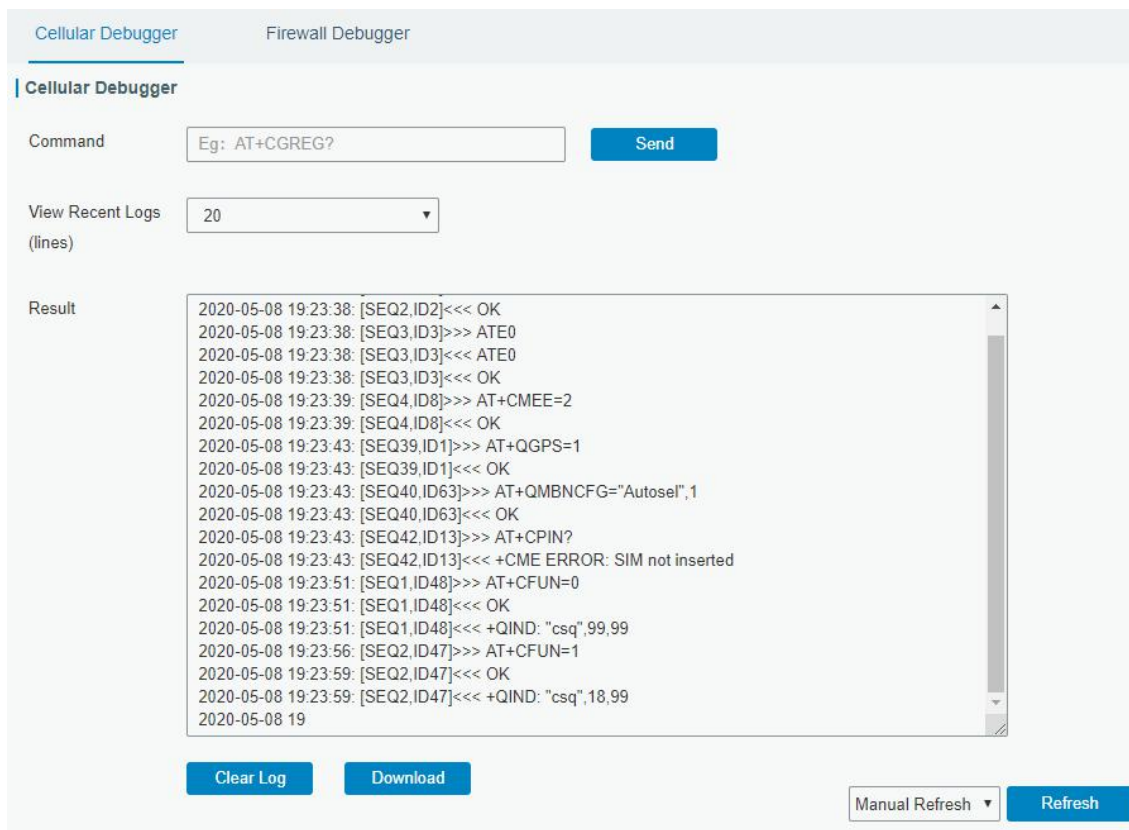

Figure 3-5-2-1

Cellular Debugger	
Item	Description
Command	Enter the AT command that you want to send to cellular modem.
View Recent Logs (lines)	View the specified lines of the result.
Result	Show the response result from cellular modem.

Table 3-5-2-1 Cellular Debugger Parameters

3.5.2.2 Firewall Debugger

This section explains how to send commands to router and check firewall information.

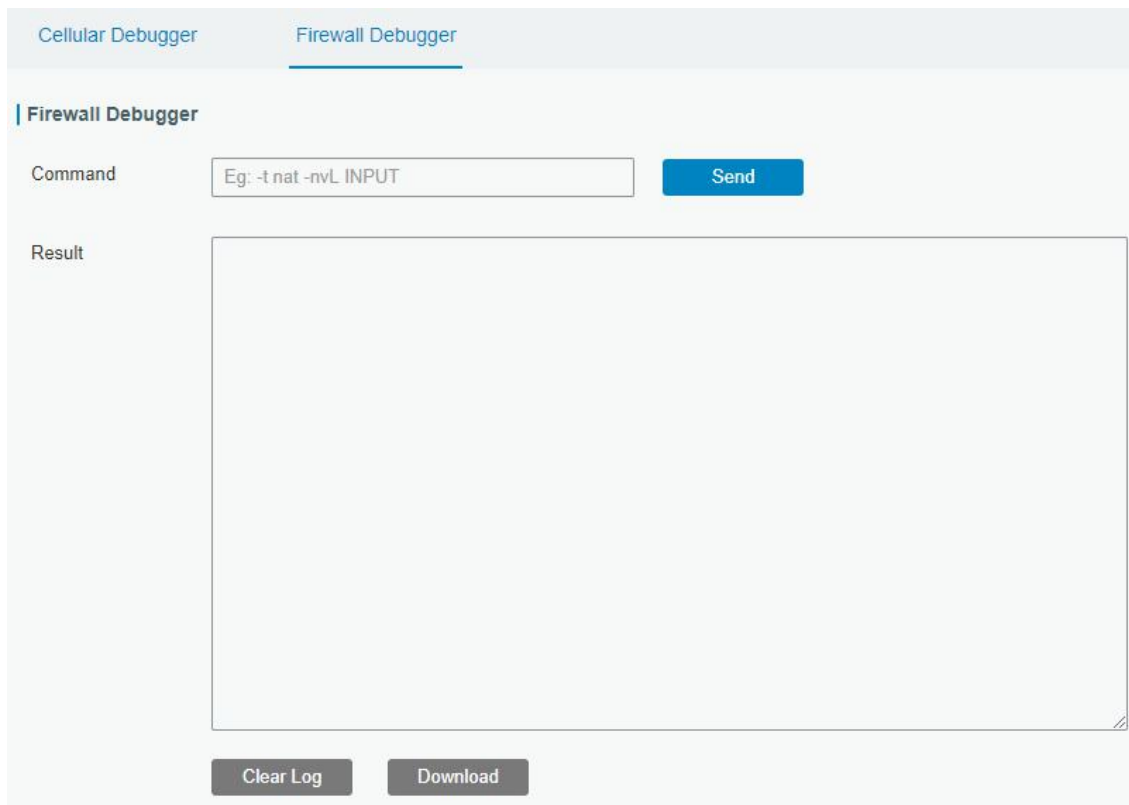

Figure 3-5-2-2

Firewall Debugger	
Item	Description
Command	Enter the iptables command to send to check firewall information.
Result	Show the response result from firewall module.

Table 3-5-2-2 Firewall Debugger Parameters

3.5.3 Log

The system log contains a record of informational, error and warning events that indicates how the system processes. By reviewing the data contained in the log, an administrator or user troubleshooting the system can identify the cause of a problem or whether the system processes are loading successfully. Remote log server is feasible, and router will upload all system logs to remote log server such as Syslog Watcher.

3.5.3.1 System Log

This section describes how to view the recent log on web.

Figure 3-5-3-1

System Log	
Item	Description
View recent (lines)	View the specified lines of system log.
Clear Log	Clear the current system log.

Table 3-5-3-1 System Log Parameter

3.5.3.2 Log Download

This section describes how to download log files.

Figure 3-5-3-2

Log Download	
Item	Description
Download All	Download all log files.

File Name	Show the name of log files.
File Size/KB	Show the size of log files.
Creation Time	Show the creation time of log files.
Operation	Click to download every log file.

Table 3-5-3-2 System Log Parameter

3.5.3.3 Log Settings

This section explains how to enable remote log server and local log setting.

Figure 3-5-3-3

Log Settings	
Item	Description
Remote Log Server	
Enable	With "Remote Log Server" enabled, router will send all system logs to the remote server.
Syslog Server Address	Fill in the remote system log server address (IP/domain name).
Port	Fill in the remote system log server port.
Local Log File	
Storage	User can store the log file in memory or TF card.
Size	Set the size of the log file to be stored.
Log Severity	The list of severities follows the syslog protocol.

Table 3-5-3-3 Log Settings Parameters

3.5.4 Upgrade

This section describes how to upgrade the router firmware via web. Generally you don't need to do the firmware upgrade.

Note: any operation on web page is not allowed during firmware upgrade, otherwise the upgrade will be interrupted, or even the device will break down.

Figure 3-5-4-1

Upgrade	
Item	Description
Firmware Version	Show the current firmware version.
Reset Configuration to Factory Default	When this option is checked, the router will be reset to factory defaults after upgrade.
Upgrade Firmware	Click "Browse" button to select the new firmware file, and click "Upgrade" to upgrade firmware.

Table 3-5-4-1 Upgrade Parameters

Related Configuration Example

[Firmware Upgrade](#)

3.5.5 Backup and Restore

This section explains how to create a complete backup of the system configurations to a file, restore the config file to the router and reset to factory defaults.

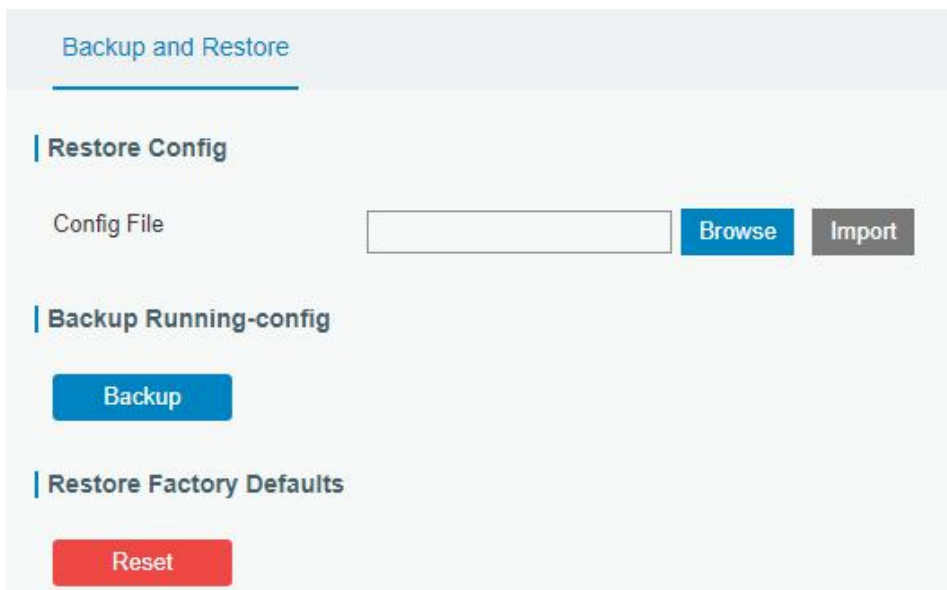

Figure 3-5-5-1

Backup and Restore	
Item	Description
Config File	Click "Browse" button to select configuration file, and then click "Import" button to upload the configuration file to the router.
Backup	Click "Backup" to export the current configuration file to the PC.
Reset	Click "Reset" button to reset factory default settings. Router will restart after reset process is done.

Table 3-5-5-1 Backup and Restore Parameters

Related Configuration Example

[Restore Factory Defaults](#)

3.5.6 Reboot

On this page you can reboot the router immediately or regularly. We strongly recommend clicking "Save" and "Apply" button before rebooting the router so as to avoid losing the new configuration.

Figure 3-5-6-1

Reboot	
Item	Description
Reboot Now	Reboot the router immediately.
Schedule	
Enable	Reboot the router at a scheduled frequency.
Cycles	Select the date and time to execute the schedule.

Table 3-5-2-1 Schedule Parameters

3.6 APP

3.6.1 Python

Python is an object-oriented programming language that has gained popularity because of its clear syntax and readability.

As an interpreted language, Python has a design philosophy that emphasizes code readability, notably using whitespace indentation to delimit code blocks rather than curly brackets or keywords, and a syntax that allows programmers to express concepts in fewer lines of code than it's used in other languages such as C++ or Java. The language provides constructs and intends to enable writing clear programs on both small and large scale.

Users can use Python to quickly generate the prototype of the program, which can be the final interface of the program, rewrite it with a more appropriate language, and then encapsulate the extended class library that Python can call.

This section describes how to view the relevant running status such as App-manager, SDK version, extended storage, etc. Also you can change the App-manager configuration, and import the Python App package from here.

3.6.1.1 Python

Figure 3-6-1-1

Python	
Item	Description
AppManager Status	Show AppManager's running status, like "Uninstalled", "Running" or "Stopped".
SDK Version	Show the version of the installed SDK.
SDK Path	Show the SDK installation path.
Available Storage	Select available storage such as eMMC to install SDK.
SDK Upload	Upload and install SDK for Python.
Uninstall	Uninstall SDK.
View	View application status managed by AppManager.

Table 3-6-1-1 Python Parameters

3.6.1.2 App Manager Configuration

Figure 3-6-1-2

AppManager Configuration	
Item	Description
Enable	After enabling Python AppManager, user can click "View" button on the

	"Python" webpage to view the application status managed by AppManager.
App Management	
ID	Show the ID of the imported App.
App Command	Show the name of the imported App.
Logfile Size(MB)	User-defined Logfile size. Range: 1-50.
Uninstall	Uninstall APP.
App Status	
App Name	Show the name of the imported App.
App Version	Show the version of the imported App.
SDK Version	Show the SDK version which the imported App is based on.

Table 3-6-1-2 APP Manager Parameters

3.6.1.3 Python App

The screenshot shows the 'Python APP' configuration page. It has three tabs: 'Python', 'AppManager Configuration', and 'Python APP'. The 'Python APP' tab is active. The page is organized into three sections:

- Import App Package:** Contains an 'App Package' input field with 'Browse' and 'Import' buttons.
- Import App Configuration:** Contains an 'App Name' dropdown menu, an 'App Configuration' input field with 'Browse' and 'Import' buttons.
- Debug Script:** Contains a 'Debug File' dropdown menu with an 'Export' button, and a 'Debug Script' input field with 'Browse' and 'Import' buttons.

Figure 3-6-1-3

Python APP	
Item	Description
App Package	Select App package and import.
App Name	Select App to import configuration.
App Configuration	Select configuration file and import.
Debug File	Export script file.
Debug Script	Select Python script to be debugged and import.

Table 3-6-1-3 APP Parameters

Chapter 4 Application Examples

4.1 Restore Factory Defaults

4.1.1 Via Web Interface

1. Log in web interface, and go to "Maintenance > Backup and Restore".
2. Click "Reset" button under the "Restore Factory Defaults".

You will be asked to confirm if you'd like to reset it to factory defaults. Then click "Reset" button.

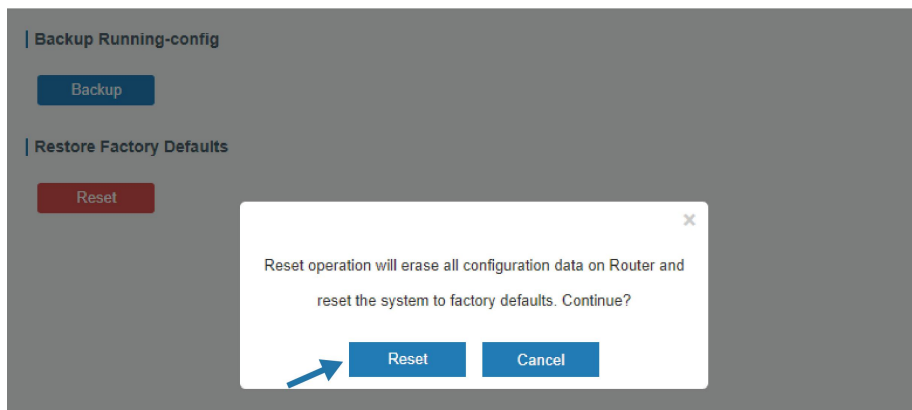
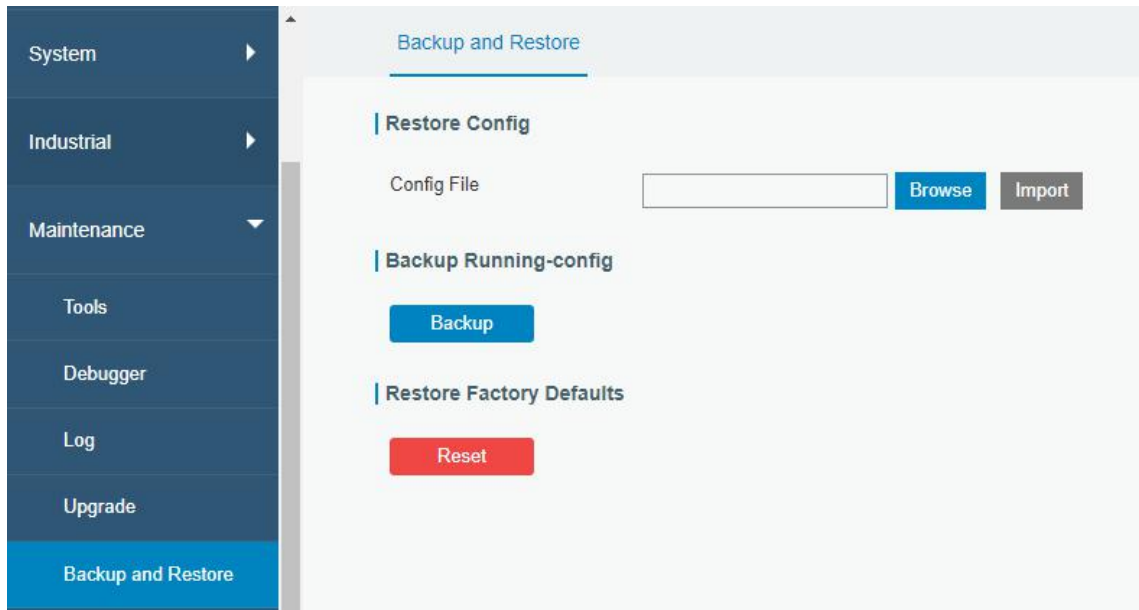

Then the router will reboot and restore to factory settings immediately.

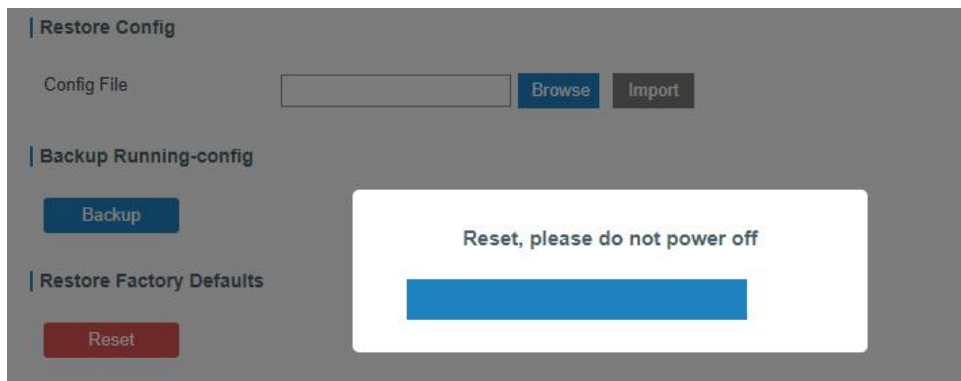

Please wait till the SYSTEM LED blinks slowly and login page pops up again, which means the router has already been reset to factory defaults successfully.

Related Topic

[Restore Factory Defaults](#)

4.2.2 Via Hardware

Locate the reset button on the router, and take corresponding actions based on the status of SYSTEM LED.

SYSTEM LED	Action
Blinking	Press and hold the reset button for more than 5 seconds.
Static Green → Rapidly Blinking	Release the button and wait.
Off → Blinking	The router is now reset to factory defaults.

4.2 Firmware Upgrade

It is suggested that you contact Milesight technical support first before you upgrade router firmware. After getting firmware file please refer to the following steps to complete the upgrade.

1. Go to "Maintenance > Upgrade".
2. Click "Browse" and select the correct firmware file from the PC.
3. Click "Upgrade" and the router will check if the firmware file is correct. If it's correct, the firmware will be imported to the router, and then the router will start to upgrade.

Note: It is recommended to check the box of Reset Configuration to Factory Default before upgrade.

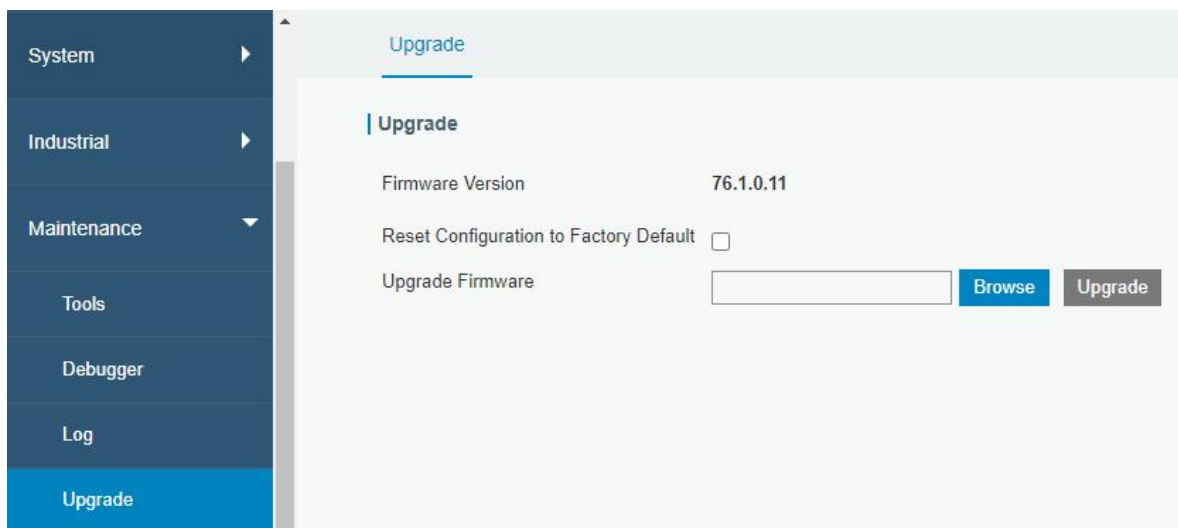

Related Topic

[Upgrade](#)

4.3 Events Application Example

Example

In this section, we will take an example of sending alarm messages by email when the following events occur and recording the event alarms on the Web GUI.

Events	Actions to make events occur (for test)
Router system start up.	Plug the power supply of the router.
Router system time update.	Set up system time manually.

Configuration Steps

1. Go to “System > Events > Events Settings” and enable Event settings.
2. Check corresponding events for record and email alarm, and then click “Save” button as below.

Events Settings

Enable

Phone Group List

Email Group List

Events	Record	Email Email Setting	SMS SMS Setting	SNMP
System Startup	<input checked="" type="checkbox"/>	<input checked="" type="checkbox"/>	<input type="checkbox"/>	<input type="checkbox"/>
System Reboot	<input type="checkbox"/>	<input type="checkbox"/>	<input type="checkbox"/>	<input type="checkbox"/>
System Time Update	<input checked="" type="checkbox"/>	<input checked="" type="checkbox"/>	<input type="checkbox"/>	<input type="checkbox"/>

3. Configure the corresponding parameters including email sending settings and email groups as below. Click “Save” and “Apply” button to make the changes take effect.

SMTP Client Settings

Enable

Email Address

Password

SMTP Server Address

Port

Encryption

Email List

Email Address	Description	Operation
iot.contact@milesight.com	support	<input type="checkbox"/>
		<input type="checkbox"/>

Email Group List

Group ID	Description	Email Address	Operation
1	support	iot.contact@milesight.com	<input type="checkbox"/> <input type="checkbox"/>
			<input type="checkbox"/>

4. To test the functionality of Alarm, please take the corresponding actions listed above. It will send an alarm e-mail to you when the relevant event occurs. Refresh the web GUI, go to “Events > Events”, and you will find the events records.

Events Events Settings

Status	Type	Time	Message
<input type="checkbox"/> Unread	System Time Update	2019-05-15 09:39:08	system time update
<input type="checkbox"/> Unread	System Startup	2019-05-09 11:48:25	system startup

< 1 > 10 Go to:

Related Topics

[Events](#)

[Email Setting](#)

4.4 SNMP Application Example

Before you configure SNMP parameters, please download the relevant “MIB” file from the UR75’s WEB GUI first, and then upload it to any software or tool which supports standard SNMP protocol. Here we take “ManageEngine MibBrowser Free Tool” as an example to access the router to query cellular information.

- Go to “System > SNMP > MIB” and download the MIB file “LTE-ROUTER-MIB.txt” to PC.

System

- General Settings
- Phone & SMS
- User Management
- SNMP**
- AAA

SNMP MIB View VACM Trap **MIB**

MIB Download

MIB File LTE-ROUTER-MIB.b

- Start “ManageEngine MibBrowser Free Tool” on the PC. Click “File > Load MIB” on the menu bar. Then select “LTE-ROUTER-MIB.txt” file from PC and upload it to the software.

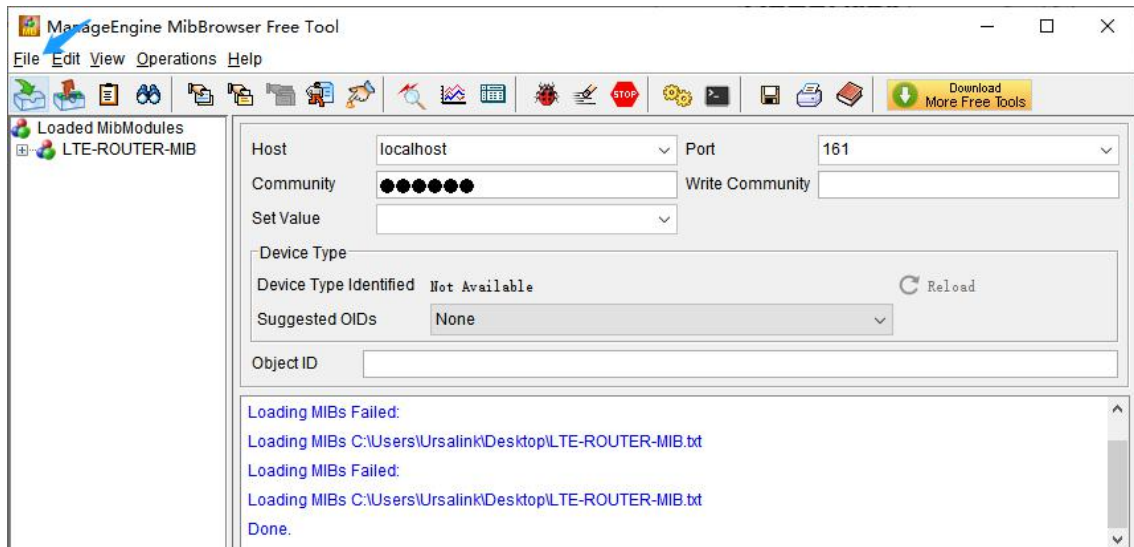

Click the “+” button beside “LTE-ROUTER-MIB”, which is under the “Loaded MibModules” menu, and find “usCellularinfo”. And then you will see the OID of cellular info is “.1.3.6.1.4.1.50234”, which will be filled in the MIB View settings.

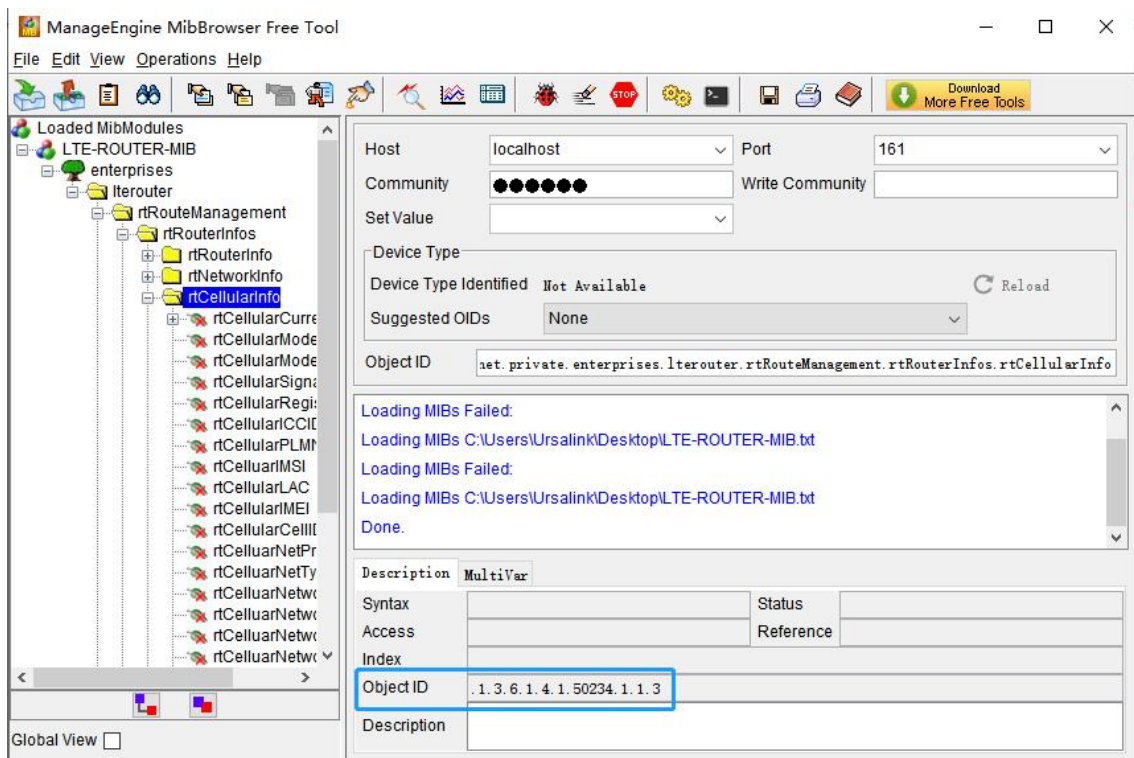

- Go to “System > SNMP > SNMP” on the router’s WEB GUI. Check “Enable” option, then click “Save” button.

SNMP MIB View VACM Trap MIB

SNMP Settings

Enable

Port

SNMP Version

Location Information



Contact Information

Save

4. Go to "System > SNMP > MIB View". Click  to add a new MIB view and define the view to be accessed from the outside network. Then click "Save" button.

SNMP MIB View VACM Trap MIB

View List



View Name	View Filter	View OID	Operation
<input type="text" value="cellular"/>	<input type="text" value="Included"/>	<input type="text" value="1.3.6.1.4.1.50234.1.3"/>	
			

Save

5. Go to "System > SNMP > VACM". Click  to add a new VACM setting to define the access authority for the specified view from the specified outside network. Click "Save" and "Apply" to make the changes take effect.

SNMP MIB View VACM Trap MIB

SNMP v1 & v2 User List

Community	Permission	MIB View	Network	Operation
<input type="text" value="public"/>	<input type="text" value="Read-Write"/>	<input type="text" value="cellular"/>	<input type="text" value="0.0.0.0/0"/>	
				

Save

6. Go to MibBrowser, enter host IP address, port and community. Right click "usCellular CurrentSim"

and then click “FET”. Then you will get the current SIM info on the result box. You can get other cellular info in the same way.

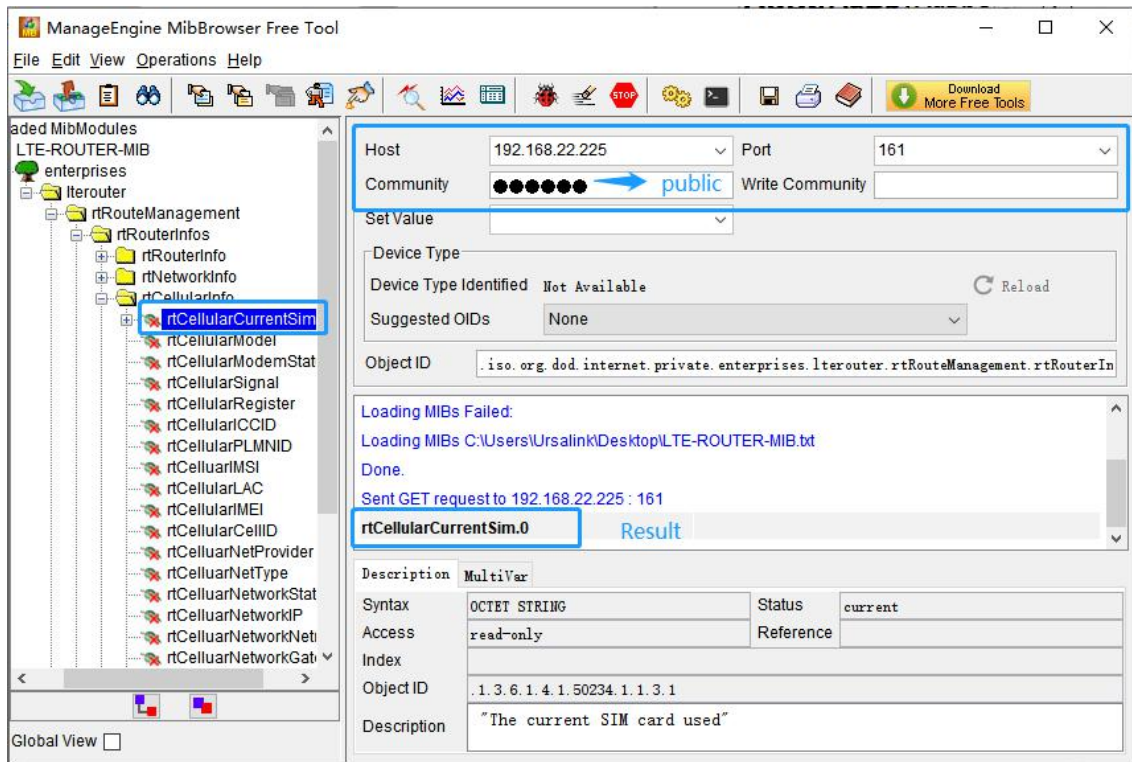

Related Topic

[SNMP](#)

4.5 Network Connection

4.5.1 Cellular Connection

The UR75 routers have two cellular interfaces, named SIM1 & SIM2. Only one cellular interface is active at one time. If both cellular interfaces are enabled, SIM1 interface takes precedence as default.

Example

We are about to take an example of inserting a SIM card into SIM1 slot of the UR75 and configuring the router to get Internet access through cellular.

Configuration Steps

1. Go to “Network > Interface > Cellular > Cellular Setting” and configure the cellular info.

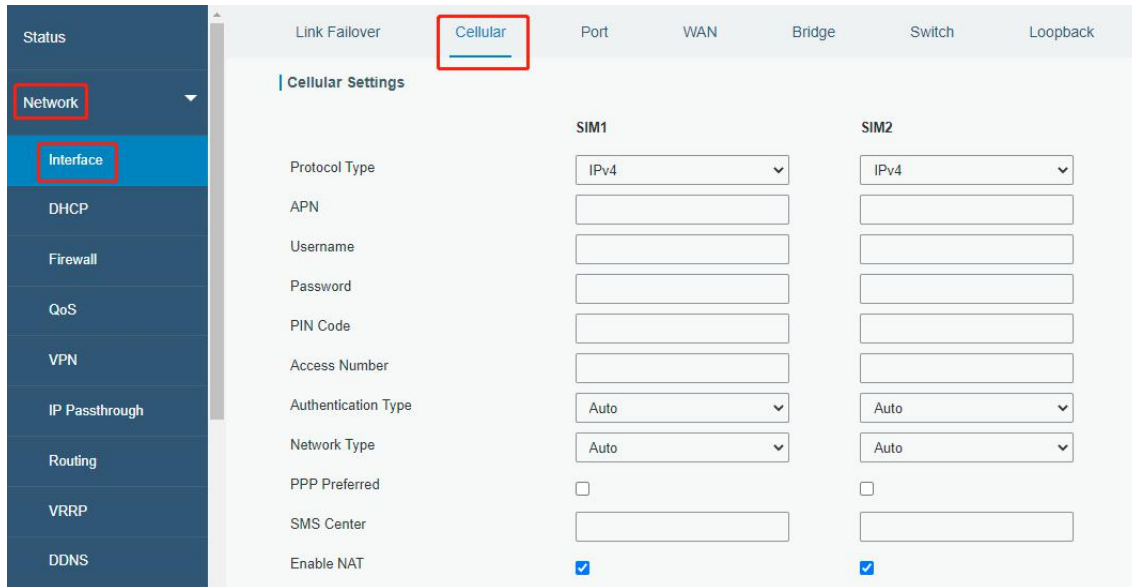

Cellular Settings

	SIM1	SIM2
Protocol Type	IPv4	IPv4
APN		
Username		
Password		
PIN Code		
Access Number		
Authentication Type	Auto	Auto
Network Type	Auto	Auto
PPP Preferred	<input type="checkbox"/>	<input type="checkbox"/>
SMS Center		
Enable NAT	<input checked="" type="checkbox"/>	<input checked="" type="checkbox"/>

Click “Save” and “Apply” for configuration to take effect.

2. Go to “Network > Interface > Link Failover” to enable correspond SIM and change link priority.

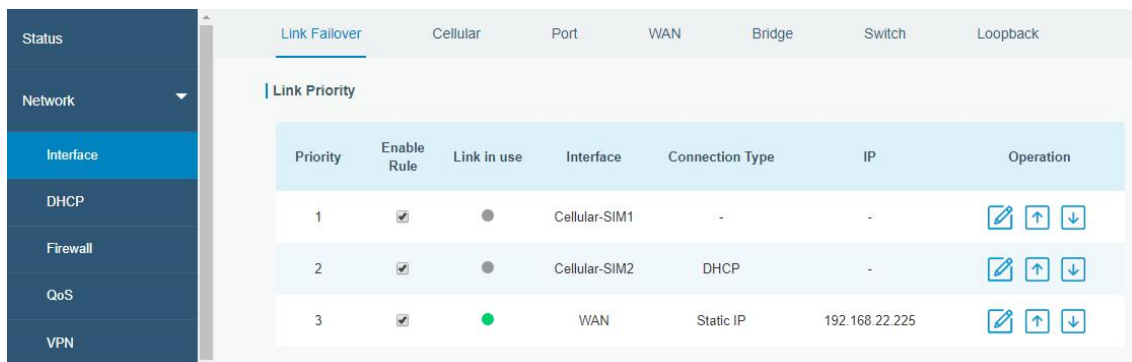

Priority	Enable Rule	Link in use	Interface	Connection Type	IP	Operation
1	<input checked="" type="checkbox"/>	<input type="radio"/>	Cellular-SIM1	-	-	
2	<input checked="" type="checkbox"/>	<input type="radio"/>	Cellular-SIM2	DHCP	-	
3	<input checked="" type="checkbox"/>	<input checked="" type="radio"/>	WAN	Static IP	192.168.22.225	

3. Click  to configure ICMP ping detection information.

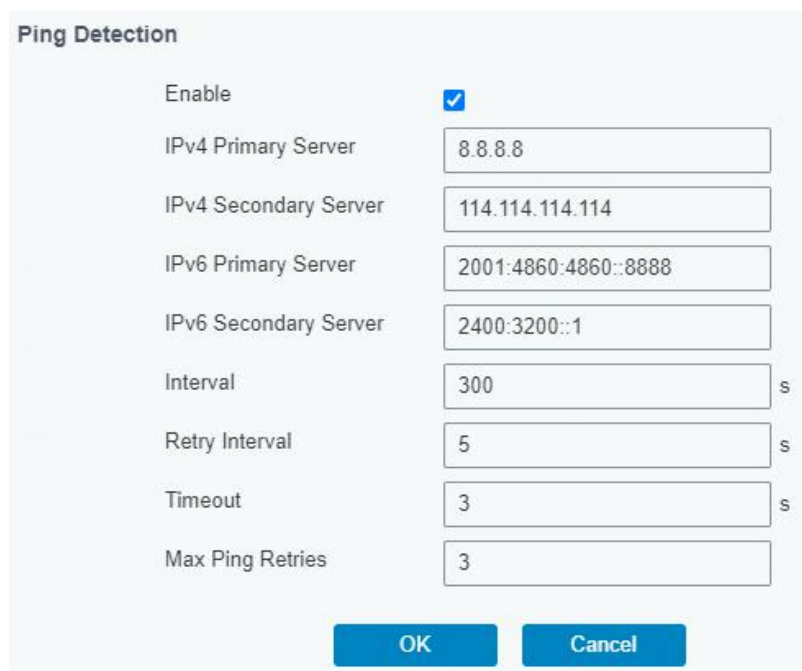

Ping Detection

Enable

IPv4 Primary Server

IPv4 Secondary Server

IPv6 Primary Server

IPv6 Secondary Server

Interval s

Retry Interval s

Timeout s

Max Ping Retries

4. Check the cellular connection status by WEB GUI of router.

Click "Status > Cellular" to view the status of the cellular connection. If it shows 'Connected', SIM1 has dialed up successfully.

Overview	Cellular	Network	WLAN	VPN	Routing	Host List	GPS
Modem		Network					
Model	EC20F	Status	Connected				
Version	EC20CEHCLGR06A05M1G	IPv4 Address	10.171.227.152/28				
Current SIM	SIM1	IPv4 Gateway	10.171.227.153				
Signal Level	31asu (-51dBm)	IPv4 DNS	211.143.147.120				
Register Status	Registered (Home network)	IPv6 Address	2409:8934:1a1e:ca08:9c3f:1718:6fcd:4ad3/64				
IMEI	861942056289607	IPv6 Gateway	2409:8934:1a1e:ca08:8e7:5c15:e8dd:111				
IMSI	460005970144200	IPv6 DNS	2409:8034:2000:0:0:0:0:4				
ICCID	898600511318F2001679	Connection Duration	0 days, 02:32:02				
ISP	CHINA MOBILE	Data Usage Monthly					
Network Type	TDD LTE	SIM-1	RX: 0.0 MIB TX: 0.0 MIB ALL: 0.0 MIB				
PLMN ID	46000	SIM-2	RX: 0.0 MIB TX: 0.0 MIB ALL: 0.0 MIB				
LAC	592f						
Cell ID	3d98485						

5. Check out if network works properly by browser on PC.

Open your preferred browser on PC, type any available web address into address bar and see if it is able to visit Internet via the UR75 router.

Related Topic

[Cellular Setting](#)

[Cellular Status](#)

4.5.2 Ethernet WAN Connection

Example

WAN port of the UR75 is connected with Ethernet cable to get Internet access.

Configuration Steps

1. Go to "Network > Interface > WAN" to select connection type and configure WAN parameters.

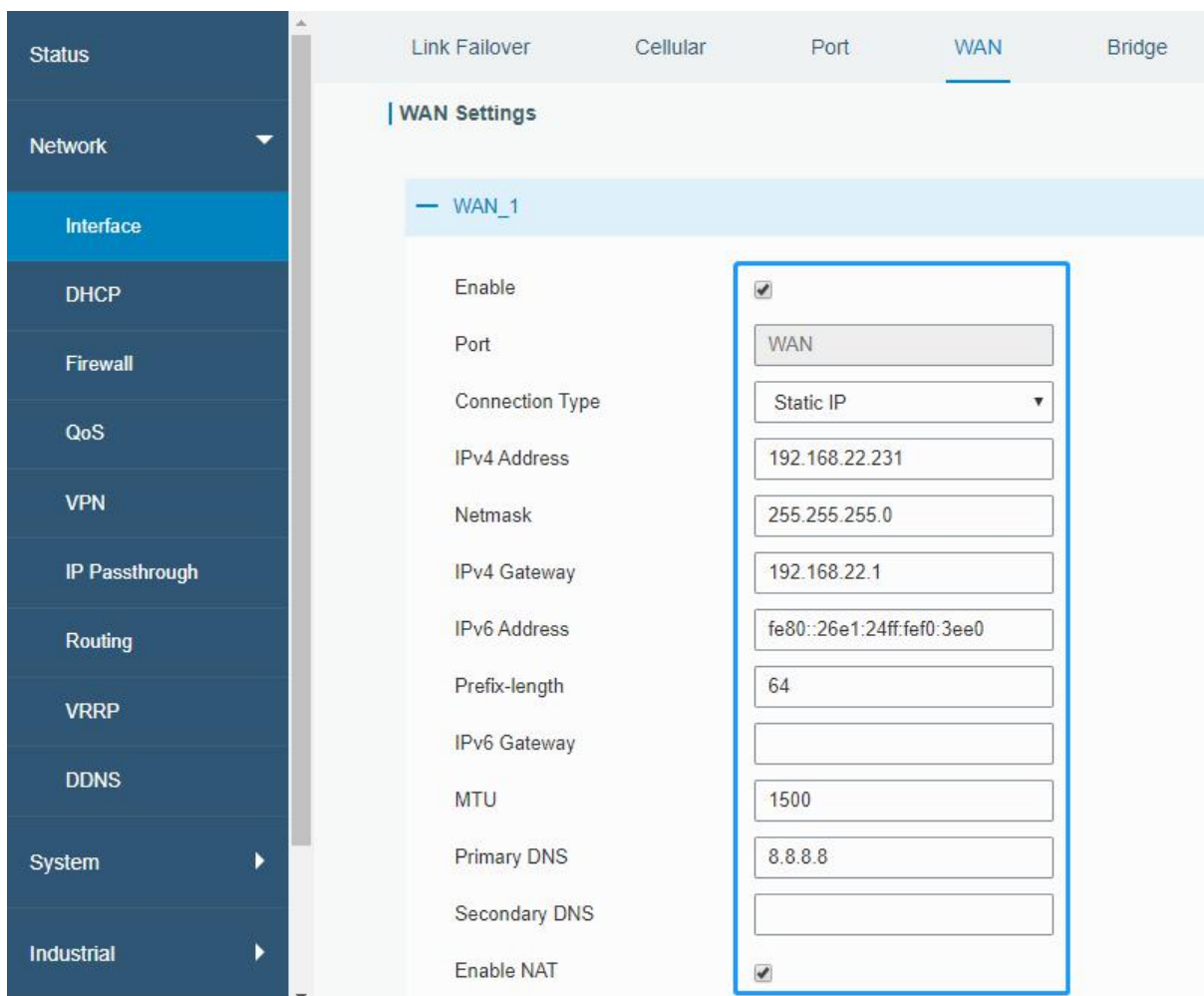

Link Failover Cellular Port **WAN** Bridge

WAN Settings

— WAN_1

Enable

Port WAN

Connection Type Static IP

IPv4 Address 192.168.22.231

Netmask 255.255.255.0

IPv4 Gateway 192.168.22.1

IPv6 Address fe80::26e1:24ff:fe0:3ee0

Prefix-length 64

IPv6 Gateway

MTU 1500

Primary DNS 8.8.8.8

Secondary DNS

Enable NAT





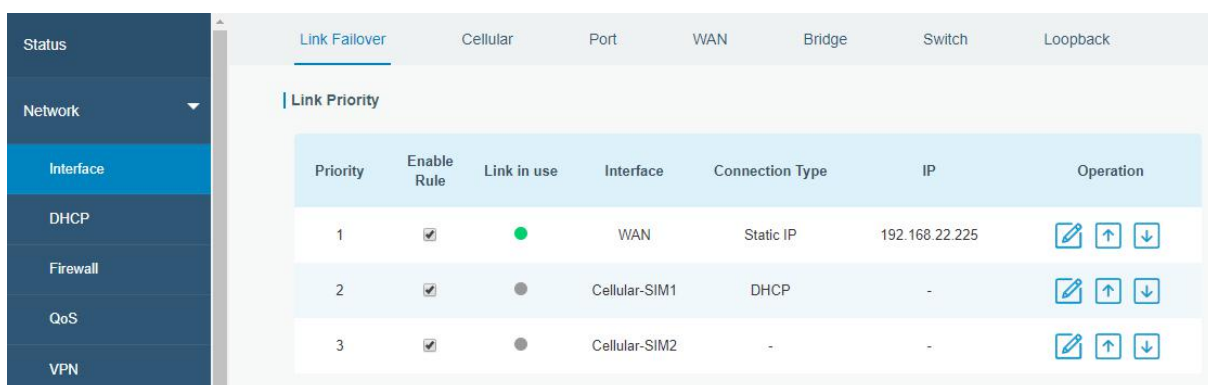



Note: if you select PPPoE type, please check the “Username” & “Password” with your local ISP. Click “Save & Apply” button to make the changes take effect.

2. Go to “Network > Interface > Link Failover” to change the WAN priority to 1.



Link Failover Cellular Port WAN Bridge Switch Loopback

Link Priority

Priority	Enable Rule	Link in use	Interface	Connection Type	IP	Operation
1	<input checked="" type="checkbox"/>	●	WAN	Static IP	192.168.22.225	  
2	<input checked="" type="checkbox"/>	●	Cellular-SIM1	DHCP	-	  
3	<input checked="" type="checkbox"/>	●	Cellular-SIM2	-	-	  

Related Topic

[WAN Setting](#)

[WAN Status](#)

4.6 Wi-Fi Application Example

4.6.1 AP Mode

Application Example

Configure UR75 as AP to allow connection from users or devices.

Configuration Steps

1. Go to “Network > Interface > WLAN” to configure wireless parameters as below.

Link Failover	Cellular	Port	WAN	Bridge	WLAN
WLAN1-2.4G					
Enable	<input checked="" type="checkbox"/>				
Work Mode		AP			
BSSID		24:e1:24:f0:d9:40			
Radio Type		802.11n(2.4GHz)			
Channel		Auto			
Bandwidth		20MHz			
SSID		Router_F0D940			
Encryption Mode		WPA-PSK/WPA2-PSK			
Cipher		Auto			
Key				
SSID Broadcast	<input checked="" type="checkbox"/>				
AP Isolation	<input type="checkbox"/>				
Guest Mode	<input type="checkbox"/>				

Click “Save” and “Apply” button after all configurations are done.

2. Use a smart phone to connect the access point of UR75. Go to “Status > WLAN”, and you can check the AP settings and information of the connected client/user.

Overview	Cellular	Network	WLAN	VPN	Routing	Host List	GPS
WLAN Status							
Name	Status	Type	SSID	IP Address	Netmask		
WLAN1	Running	AP	Router_F0D940	192.168.10.1	255.255.255.0		
WLAN2	Running	AP	Router_F0D941	192.168.10.1	255.255.255.0		
Associated Stations							
SSID	MAC Address	IP Address	Connection Duration				
Router_F0D940	3c:cd:5d:47:10:8e	192.168.10.100	6 seconds				

4.6.2 Client Mode

Application Example

Configure UR75 as Wi-Fi client to connect to an access point to have Internet access.

Configuration Steps

1. Go to "Network > Interface > WLAN" to configure wireless as below.

The screenshot shows the configuration page for WLAN1-2.4G. The 'WLAN' tab is selected. The 'Enable' checkbox is checked. The 'Work Mode' is set to 'Client'. The 'SSID' is 'WIFI TEST', 'BSSID' is '3C:CD:5D:47:10:8E', 'Encryption Mode' is 'WPA2-PSK', and 'Cipher' is 'AES'. The 'Key' field is masked with dots. The 'IP Setting' is set to 'DHCP Client'. A 'Scan' button is visible next to the Work Mode dropdown.

Click "Save" and "Apply" button after all configurations are done.

2. Go to "Status > WLAN", and you can check the connection status of the client.

The screenshot shows the 'WLAN Status' page. The 'WLAN' tab is selected. The page displays two tables. The first table, 'WLAN Status', has columns: Name, Status, Type, SSID, IP Address, and Netmask. The second table, 'Associated Stations', has columns: SSID, MAC Address, IP Address, and Connection Duration.

Name	Status	Type	SSID	IP Address	Netmask
WLAN1	Connected	Client	WIFI TEST	192.168.43.10	255.255.255.0
WLAN2	Running	AP	Router_F0D941	192.168.10.1	255.255.255.0

SSID	MAC Address	IP Address	Connection Duration
WIFI TEST	3c:cd:5d:47:10:8e	192.168.43.1	3 seconds

Related Topic

[WLAN Setting](#)

[WLAN Status](#)

4.7 VRRP Application Example

Application Example

A Web server requires Internet access through the UR75 router. To avoid data loss caused by router breakdown, two UR75 routers can be deployed as VRRP backup group, so as to improve network reliability.

VRRP group:

WAN ports of the UR75 Router A and Router B are connected to the Internet via wired network. And LAN ports of them are connected to a switch.

Virtual IP is 192.168.1.254/24.

UR75 Router	Virtual Router ID (Same for A and B)	Port connected with switch	LAN IP Address	Priority	Preemption Mode
A	1	LAN2	192.168.1.1	110	Enable
B	1	LAN2	192.168.1.2	100	Disable

Refer to the topological below.

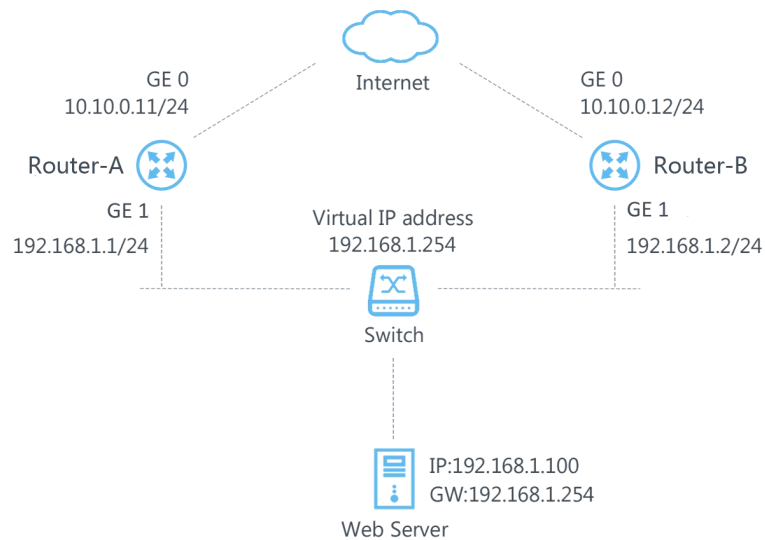

Configuration Steps

Router A Configuration

1. Go to "Network > Interface > WAN" and configure wired WAN connection as below.

Link Failover	Cellular	Port	WAN	Bridge
WAN_1				
Enable	<input checked="" type="checkbox"/>			
Port	WAN			
Connection Type	Static IP			
IPv4 Address	10.10.0.11			
Netmask	255.255.255.0			
IPv4 Gateway	10.10.0.1			
IPv6 Address	fe80::26e1:24ff:fe0:3ee0			
Prefix-length	64			
IPv6 Gateway				
MTU	1500			
Primary DNS	8.8.8.8			
Secondary DNS				
Enable NAT	<input checked="" type="checkbox"/>			

2. Go to “Network > VRRP > VRRP” and configure VRRP parameters as below.

Status	Network	Interface	DHCP	Firewall	QoS	VPN	IP Passthrough	Routing	VRRP	DDNS	System
VRRP											
VRRP Status											
Status	DISABLE										
VRRP Settings											
Enable	<input checked="" type="checkbox"/>										
Interface	Bridge0										
Virtual Router ID	1										
Virtual IP	192.168.1.254										
Priority	110										
Advertisement Interval (s)	1										
Preemption Mode	<input type="checkbox"/>										
IPv4 Primary Server	8.8.8.8										
IPv4 Secondary Server	114.114.114.114										
Interval	300										s
Retry Interval	5										s
Timeout	3										s
Max Ping Retries	3										

Router B Configuration

- Go to “Network > Interface > WAN” and configure wired WAN connection as below.



Link Failover	Cellular	Port	WAN	Bridge
WAN_1				
Enable	<input checked="" type="checkbox"/>			
Port		WAN		
Connection Type		Static IP		
IPv4 Address		10.10.0.12		
Netmask		255.255.255.0		
IPv4 Gateway		10.10.0.1		
IPv6 Address		fe80::26e1:24ff:fe0:3ee0		
Prefix-length		64		
IPv6 Gateway				
MTU		1500		
Primary DNS		8.8.8.8		
Secondary DNS				
Enable NAT	<input checked="" type="checkbox"/>			

- Go to “Network > Link Failover > VRRP” and configure VRRP parameters as below.

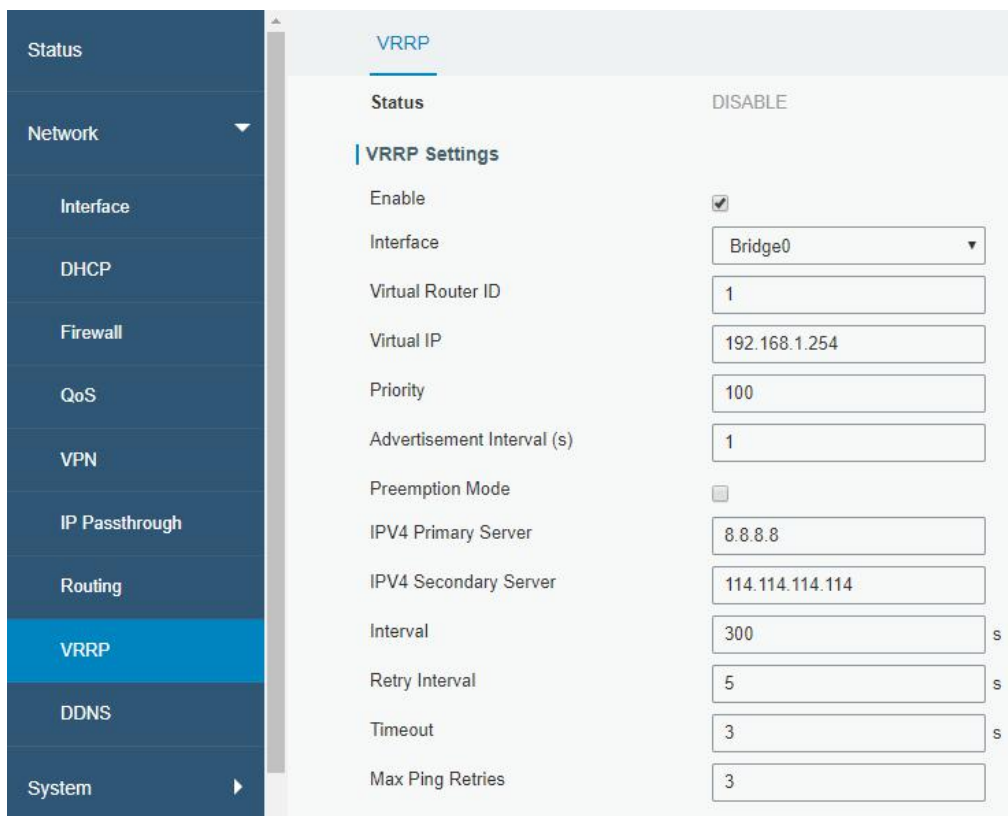

Status	Network	Interface	DHCP	Firewall	QoS	VPN	IP Passthrough	Routing	VRRP	DDNS	System
VRRP											
Status									DISABLE		
VRRP Settings											
Enable									<input checked="" type="checkbox"/>		
Interface									Bridge0		
Virtual Router ID									1		
Virtual IP									192.168.1.254		
Priority									100		
Advertisement Interval (s)									1		
Preemption Mode									<input type="checkbox"/>		
IPV4 Primary Server									8.8.8.8		
IPV4 Secondary Server									114.114.114.114		
Interval									300	s	
Retry Interval									5	s	
Timeout									3	s	
Max Ping Retries									3		

Once you complete all configurations, click “Apply” button on the top-right corner to make changes

take effect.

Result: normally, A is the master router, used as the default gateway. When the power of Router A is down or Router A suffers from failure, Router B will become the master router, used as the default gateway. With Preemption Mode enabled, Router A will be master and Router B will demote back to be the backup once Router A can access the Internet again.

Related Topics

[VRRP Setting](#)

4.8 NAT Application Example

Example

An UR75 router can access Internet via cellular. LAN port is connected with a Web server whose IP address is 192.168.1.2 and port is 8000. Configure the router to make public network access the server.

Configuration Steps

Go to “Firewall > Port Mapping” and configure port mapping parameters.

The screenshot shows the Milesight web interface. At the top, there is a navigation bar with the Milesight logo and an 'Apply' button. Below the navigation bar, there is a warning message: "For your device security, please change the default password!". The main content area is divided into several tabs: Security, ACL, Port Mapping (selected), DMZ, MAC Binding, Custom Rules, and SPI. The 'Port Mapping' tab is active, and it displays a table with the following columns: Source IP, Source Port, Destination IP, Destination Port, Protocol, Description, and Operation. A new rule is being added, with the following values: Source IP: 0.0.0.0/0, Source Port: 8000, Destination IP: 192.168.1.2, Destination Port: 800, Protocol: TCP. The 'Save' button is highlighted with a circled '4'.

Click “Save” and “Apply” button.

Related Topic

[Port Mapping](#)

4.9 Access Control Application Example

Application Example

LAN port of the UR75 is set with IP 192.168.1.0/24. Then configure the router to deny accessing to Google IP 172.217.160.100 from local device with IP 192.168.1.12.

Configuration Steps

1. Go to “Network > Firewall > ACL” to configure access control list. Click “+” button to set

parameters as below. Then click “Save” button.

Security **ACL** Port Mapping DMZ MAC Binding Custom Rules SPI

ACL Setting

Default Filter Policy

Access Control List

Type

ID

Action

Protocol

Source IP

Source Wildcard Mask

Destination IP

Destination Wildcard Mask

Description

2. Configure interface list. Then click “Save” and “Apply” button.

Security **ACL** Port Mapping DMZ MAC Binding Custom Rules SPI

ACL Setting

Default Filter Policy

Access Control List

ID	Action	Protocol	Source IP	Destination IP	More Detail	Description	Operation
100	deny	ip	192.168.1.12/0.0.0.255	172.217.160.100/0.0.255		google	<input type="button" value="X"/>
							<input type="button" value="+"/>

Interface List

Interface	In ACL	Out ACL	Operation
<input type="text" value="Bridge0"/>	<input type="text" value="100"/>	<input type="text"/>	<input type="button" value="X"/>
			<input type="button" value="+"/>

Related Topic

[ACL](#)

4.10 QoS Application Example

Example

Configure the UR75 router to distribute local preference to different FTP download channels. The total download bandwidth is 75000 kbps.

Note: the “Total Download Bandwidth” should be less than the real maximum bandwidth of WAN or cellular interface.

FTP Server IP & Port	Percent	Max Bandwidth(kbps)	Min Bandwidth(kbps)
110.21.24.98:21	40%	30000	25000
110.32.91.44:21	60%	45000	40000

Configuration Steps

- Go to “Network > QoS > QoS(Download)” to enable QoS and set the total download bandwidth.

Download Bandwidth

Enable

Default Category

Download Bandwidth kbits/s

Capacity

- Please find “Service Category” option, and click “+” to set up service classes.

Note: the percents must add up to 100%.

Service Category

Name	Percent(%)	Max BW(kbps)	Min BW(kbps)	Operation
1	40	30000	25000	<input type="button" value="X"/>
2	60	45000	40000	<input type="button" value="X"/>
				<input type="button" value="+"/>

- Please find “Service Category Rules” option, and click “+” to set up rules.

Service Category Rules

Name	Source IP	Source Port	Destination IP	Destination Port	Protocol	Service Category	Operation
ftp1	110.21.24.98	21			ANY	1	<input type="button" value="X"/>
ftp2	110.32.91.44	21			ANY	2	<input type="button" value="X"/>
							<input type="button" value="+"/>

Note:

IP/Port: null refers to any IP address/port.

Click “Save” and “Apply” button.

Related Topic

[QoS Setting](#)

4.11 DTU Application Example

Example

PLC is connected with the UR75 via RS232. Then enable DTU function of the UR75 to make a remote TCP server communicate with PLC. Refer to the following topological graph.

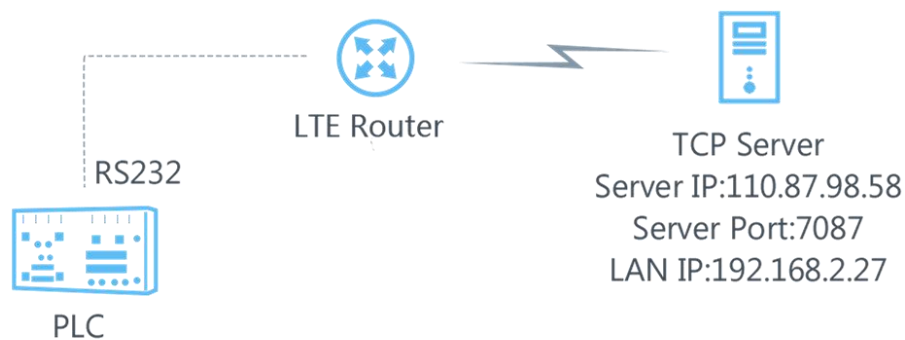

Serial Parameters of the PLC	
Baud Rate	9600
Data Bit	8
Stop Bit	1
Parity	None

Configuration Steps

1. Go to "Industrial > Serial Port > Serial" and configure serial port parameters. The serial port parameter shall be kept in consistency with those of PLC, as shown in figure below.

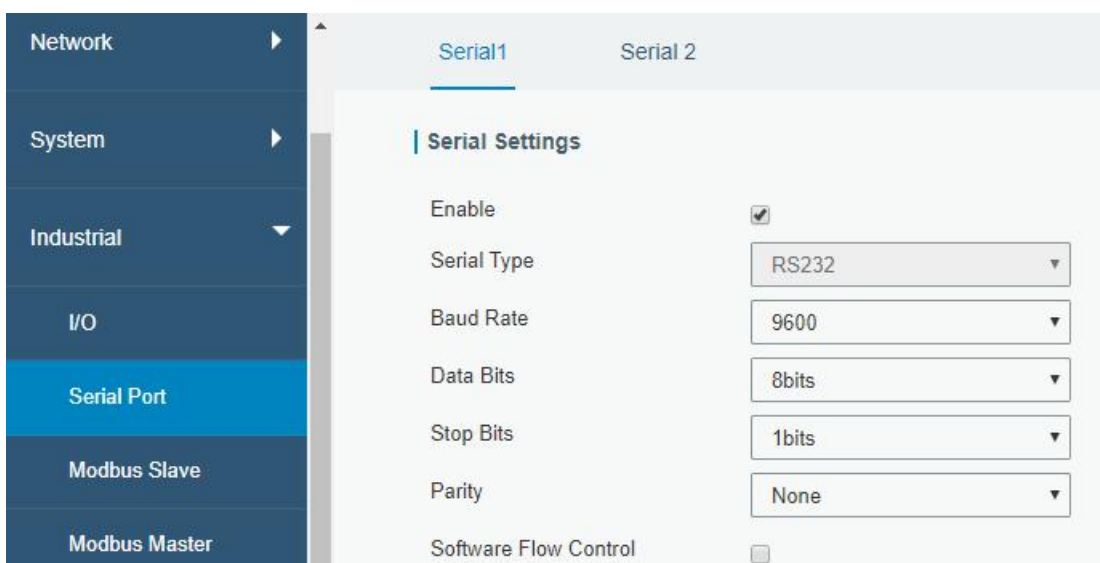

- Configure Serial Mode as “DTU Mode”. The UR75 is connected as client in “Transparent” protocol.

The screenshot shows the configuration page for the Serial Port. On the left is a navigation menu with options: System, Industrial, I/O, Serial Port (selected), Modbus TCP, GPS, and Maintenance. The main configuration area includes the following fields:

- Serial Mode: DTU Mode
- DTU Protocol: Transparent
- Protocol: TCP
- Keepalive Interval: 75 s
- Keepalive Retry Times: 9
- Packet Size: 1024 Bytes
- Serial Frame Interval: 100 ms
- Reconnect Interval: 10 s
- Specific Protocol:
- Register String: modem1

- Configure TCP server IP and port.

The screenshot shows the 'Destination IP Address' configuration table. It has columns for Server Address, Server Port, Status, and Operation. A single entry is shown with Server Address 110.87.98.58 and Server Port 7087. The Status column is empty, and the Operation column contains a delete icon (X) and an add icon (+). A 'Save' button is located below the table.

Server Address	Server Port	Status	Operation
110.87.98.58	7087		X +

- Once you complete all configurations, click “Save” and “Apply” button.

The screenshot shows the 'Destination IP Address' configuration table after saving. The Status column now displays 'Connected' in green text. The delete and add icons are still present in the Operation column.

Server Address	Server Port	Status	Operation
110.87.98.58	7087	Connected	X +

- Start TCP server on PC.

Take “Netassist” test software as example. Make sure port mapping is already done.

The screenshot shows the 'Settings' window of the Netassist software. It contains the following configuration:

- (1) Protocol: TCP Server
- (2) Local host IP: 192.168.2.27
- (3) Local host port: 7087
- A 'Disconnect' button with a red status indicator.

- Connect the UR75 to PC via RS232 for PLC simulation. Then start “sscom” software on the PC to test communication through serial port.

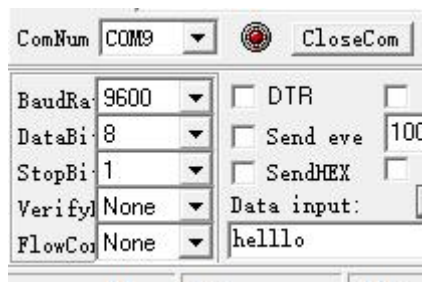

7. After connection is established between the UR75 and the TCP server, you can send data between ssscom and Netassist.

PC side

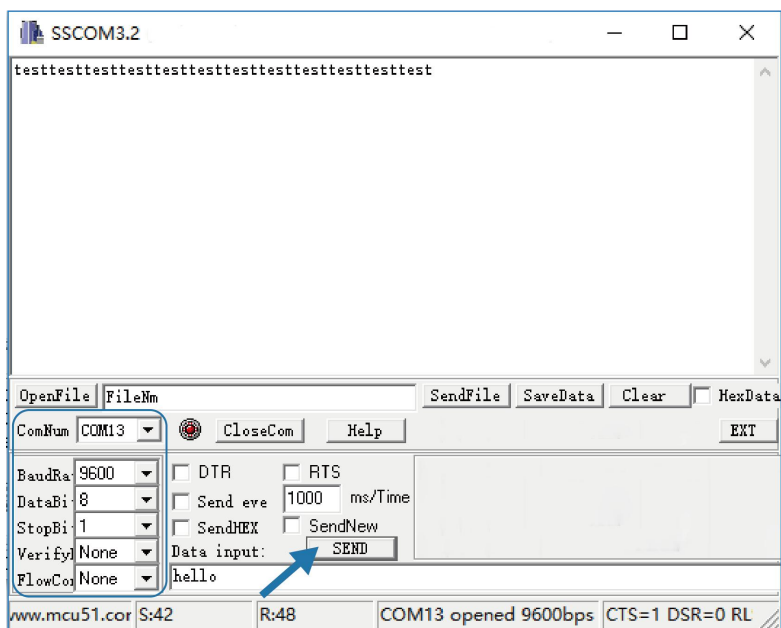

TCP server side

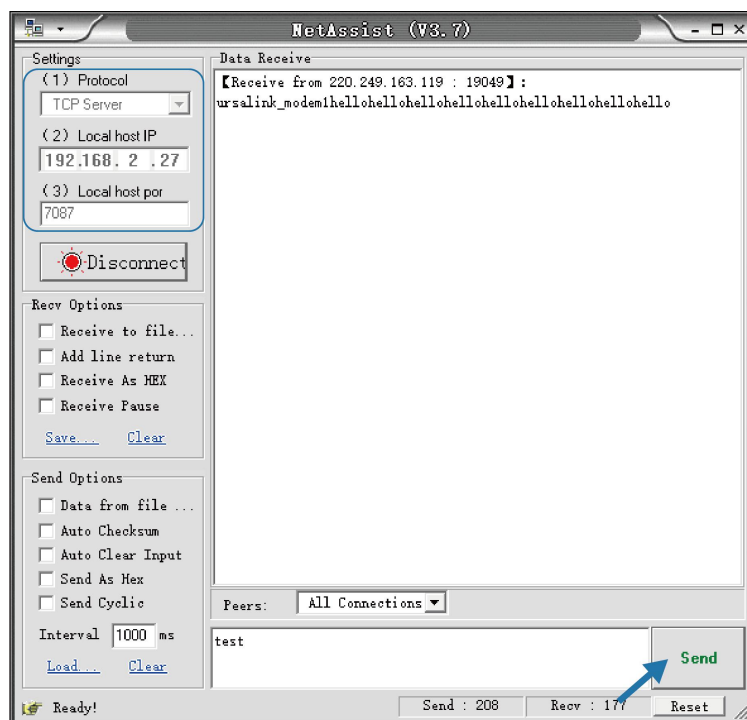

8. After serial communication test is done, you can connect PLC to RS232 port of the UR75 for test.

Related Topic

[Serial Port](#)

4.12 PPTP Application Example

Example

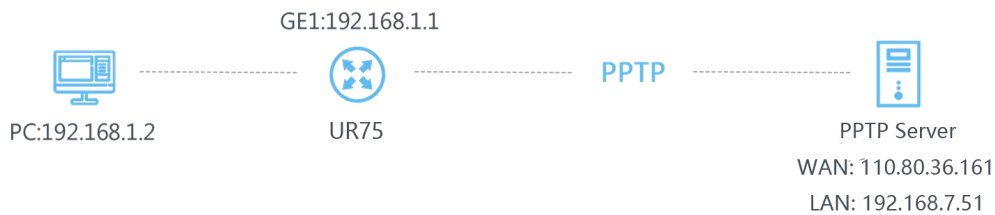

Configure the UR75 as PPTP client to connect to a PPTP server in order to have data transferred securely. Refer to the following topological graph.

Configuration Steps

1. Go to “Network > VPN > PPTP”, configure PPTP server IP address, username and password provided by PPTP server.

Note: If you want to have all data transferred through VPN tunnel, check “Global Traffic Forwarding” option.

The screenshot shows the PPTP configuration page. The 'PPTP' tab is selected. Under 'PPTP Settings', the 'PPTP_1' configuration is shown. The 'Enable' checkbox is checked. The 'Remote IP Address' is set to 110.87.98.58. The 'Username' is ptpserver and the 'Password' is masked with dots. The 'Authentication' dropdown is set to 'Auto'. The 'Global Traffic Forwarding' checkbox is unchecked. The 'Remote Subnet' and 'Remote Subnet Mask' fields are empty. The 'Advanced Settings' checkbox is also unchecked.

If you want to access peer subnet such as 192.168.3.0/24, you need to configure the subnet and mask to add the route.

Status	Overview	Cellular	Network	WLAN	VPN	Routing	Host List	GPS												
Network	Clients																			
System	<table><thead><tr><th>Name</th><th>Status</th><th>Local IP</th><th>Remote IP</th></tr></thead><tbody><tr><td>pptp_1</td><td>Connected</td><td>120.205.0.100</td><td>205.205.0.1/32</td></tr><tr><td>ipsec_1</td><td>Disconnected</td><td>-</td><td>-</td></tr></tbody></table>								Name	Status	Local IP	Remote IP	pptp_1	Connected	120.205.0.100	205.205.0.1/32	ipsec_1	Disconnected	-	-
Name	Status	Local IP	Remote IP																	
pptp_1	Connected	120.205.0.100	205.205.0.1/32																	
ipsec_1	Disconnected	-	-																	
Industrial																				

Related Topics

[PPTP Setting](#)

[PPTP Status](#)

[END]