

AI ToF People Counting Sensor

Featuring LoRaWAN®

VS133

User Guide



Safety Precautions

Milesight will not shoulder responsibility for any loss or damage resulting from not following the instructions of this operating guide.

- ❖ Though the device is compliant with Class 1 (IEC/EN 60825-1:2014), please **DO NOT** look at the ToF sensor too close and directly.
- ❖ The device must not be disassembled or remodeled in any way.
- ❖ To avoid risk of fire and electric shock, do keep the product away from rain and moisture before installation.
- ❖ Do not place the device where the temperature is below/above the operating range.
- ❖ **Do not touch the device directly to avoid the scalds when the device is running.**
- ❖ The device must never be subjected to shocks or impacts.
- ❖ Make sure the device is firmly fixed when installing.
- ❖ Do not expose the device to where laser beam equipment is used.
- ❖ Use a soft, dry cloth to clean the lens of the device.

Declaration of Conformity

VS133 is in conformity with the essential requirements and other relevant provisions of the CE, FCC, and RoHS.



Copyright © 2011-2024 Milesight. All rights reserved.

All information in this guide is protected by copyright law. Whereby, no organization or individual shall copy or reproduce the whole or part of this user guide by any means without written authorization from Xiamen Milesight IoT Co., Ltd.

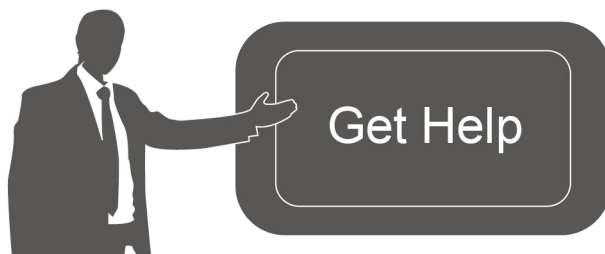

For assistance, please contact

Milesight technical support:

Email: iot.support@milesight.com

Support Portal: support.milesight-iot.com

Tel: 86-592-5085280

Fax: 86-592-5023065

Address: Building C09, Software Park
Phase III, Xiamen 361024,
China

Revision History

Date	Doc Version	Description
May 24, 2023	V1.0	Initial version
Aug. 10, 2023	V1.1	<ol style="list-style-type: none">1. Add staff lanyard accessory;2. Add installation height detection feature;3. Add DST time feature;4. Add ToF frequency setting.
Sep. 28, 2023	V1.2	<ol style="list-style-type: none">1. Add Region Monitoring function;2. Add Feet Tracking tracking mode of counting;3. Add preview layout edition feature;4. Add cumulative count reset schedule feature.
Nov. 30, 2023	V1.3	<ol style="list-style-type: none">1. Add Group Counting function;2. Add video validation function;3. Add other functions.
Mar. 31, 2024	V1.4	<ol style="list-style-type: none">1. Support to configure WLAN IP address;2. Add ToF lighting mode and noise filtering;3. Add validation record task list.
May 20, 2024	V1.5	<ol style="list-style-type: none">1. Add Enhanced Detection Mode.2. Update installation distance.
Jun. 19, 2024	V1.6	Add People Counting Trigger Report.

Contents

1. Product Introduction	5
1.1 Overview	5
1.2 Key Features	5
2. Hardware Introduction	5
2.1 Packing List	5
2.2 Hardware Overview	6
2.3 Button and LED Indicators	6
2.4 Dimensions (mm)	6
3. Power Supply	7
4. Access the Sensor	7
5. Operation Guide	8
5.1 Dashboard	8
5.2 Rule	9
5.3 Communication	13
5.3.1 WLAN	13
5.3.2 LoRa	14
5.4 Report	17
5.5 Validation	18
5.6 System	21
5.6.1 Device Info	21
5.6.2 User	21
5.6.3 Time Configuration	23
5.6.4 System Maintenance	23
6. Installation Instruction	26
6.1 Installation Height	26
6.2 Covered Detection Area	26
6.3 Environment Requirements	27
6.4 Installation	28
6.5 Factors Affecting Accuracy	30
7. Communication Protocol	30
7.1 Uplink Data	31
7.2 Downlink Command	33

1. Product Introduction

1.1 Overview

VS133 is a sensor that uses second-generation ToF technology to accurately count people. This technology provides more precise depth maps and longer detection distances while maintaining an excellent privacy protection rate. The advanced ToF technology combined with an AI algorithm enables the sensor to handle complex scenes and distinguish non-human objects with up to 99.8% accuracy. VS133 sensor can be used in conjunction with the Milesight LoRaWAN[®] gateways and the Milesight IoT Cloud. With easy installation, VS133 sensors are ideal for entrances or corridors in retail stores, malls, offices, subways, and other locations.

1.2 Key Features

- Up to 99.8% accuracy combining the 2nd generation ToF technology and AI algorithm
- Working well even in low-light or completely dark environments with great lighting adaptability
- Free from privacy concerns without image capturing
- Allow to collect people counting data by differentiating between children and adults and detecting staffs via identification features for clearer people analysis
- Smart U-turn detection to filter redundant counting of people wandering in the area
- Support queuing management via dwell time detection and regional people counting
- Wider field angle to obtain longer-distance depth maps and cover a larger area
- Store a million counting data locally and securely
- Support video validation function to help customers verify statistical accuracy
- Easy configuration via Wi-Fi for web GUI configuration
- Function well with standard LoRaWAN[®] gateways and network servers
- Quick and easy management with Milesight IoT Cloud

2. Hardware Introduction

2.1 Packing List

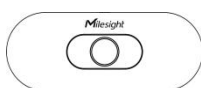

1 × VS133 Device



4 × Ceiling Mounting



8 × Staff Tags



1 × Power Adapter

Kits



1 x VB01 Multifunctional
Bracket Kit (Optional)

8 x Staff Lanyards
(Optional)

1 x
Quick Guide

1 x
Warranty Card

! If any of the above items is missing or damaged, please contact your sales representative.

2.2 Hardware Overview

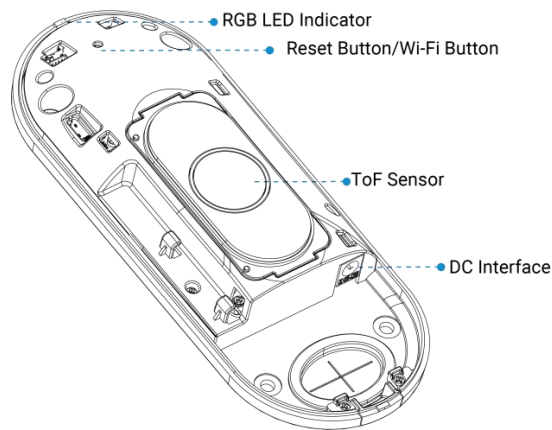

2.3 Button and LED Indicators

Function	Action	LED Indication
Turn On/Off Wi-Fi	Press and hold the button for more than 3 seconds.	Blue blinks 3s Wi-Fi on: Blue on Wi-Fi off: Green on
Reset to Factory Default	Press and hold the reset button for more than 10 seconds.	Green Blinks.

2.4 Dimensions (mm)

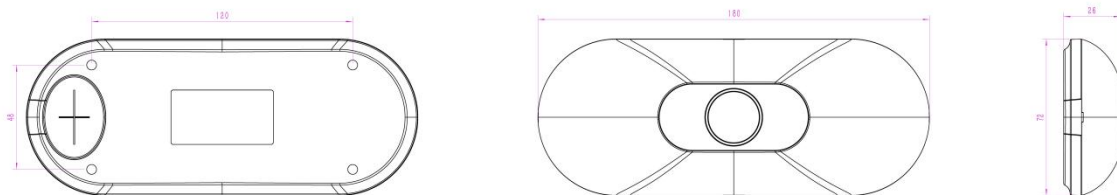

3. Power Supply

VS133 can be powered by power adapter (12VDC, 2A).

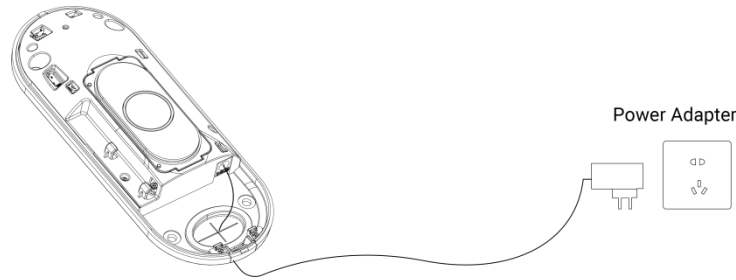

4. Access the Sensor

VS133 provides user-friendly web GUI for configuration and users can access it via Wi-Fi connection. The recommended browsers are Chrome and Microsoft Edge. The default IP of Wi-Fi is **192.168.1.1**, and default SSID is **People Counter_XXXXXX** (can be found on the label).

Step 1: Power on the device.

Step 2: Enable the Wireless Network Connection on your computer and search for corresponding access point, then connect computer to this access point.

Step 3: Open the Browser and type 192.168.1.1 to access the web GUI.

Step 4: Select the language.

Step 5: Users need to set the password and three security questions when using the sensor for the first time (three questions can be skipped by refreshing webpage). After configuration, log in with username (admin) and custom password.

Note:

- 1) Password must be 8 to 16 characters long, which contains at least two kinds or more in combination with numbers, lowercase letters, uppercase letters and special characters .
- 2) You can click the "forgot password" in login page to reset the password by answering three security questions when you forget the password if you set the security questions in advance.

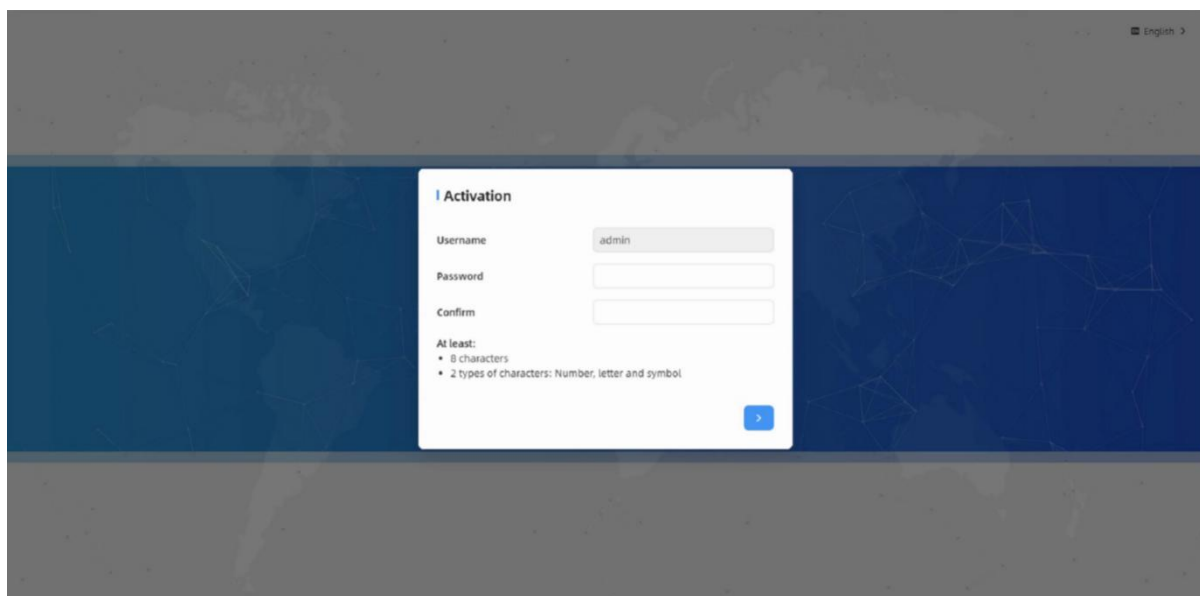

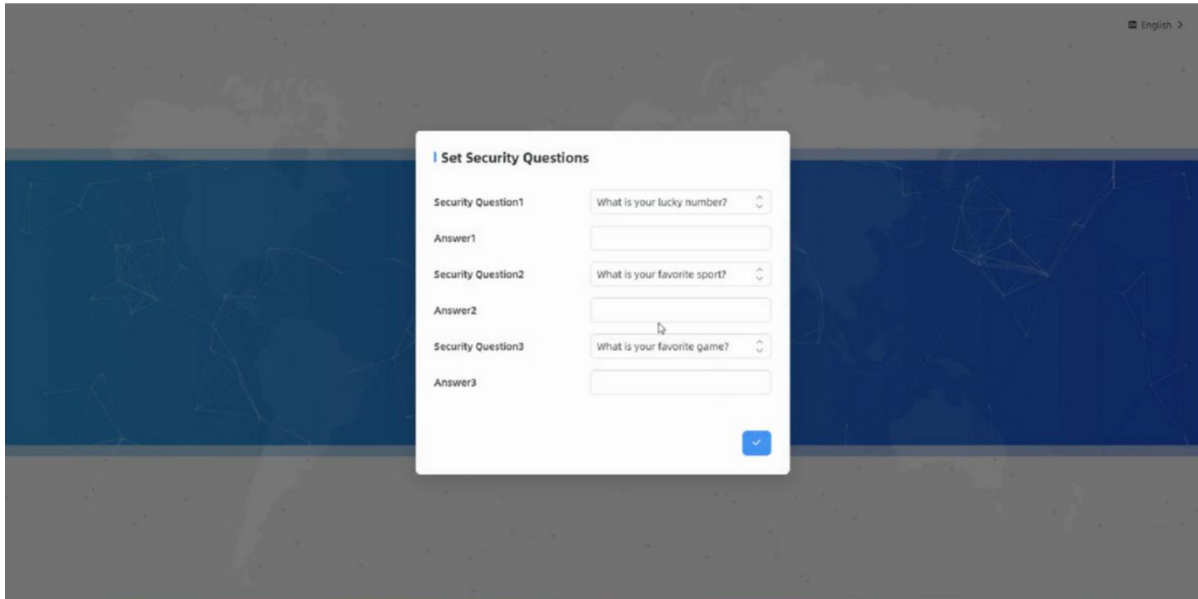



5. Operation Guide

5.1 Dashboard

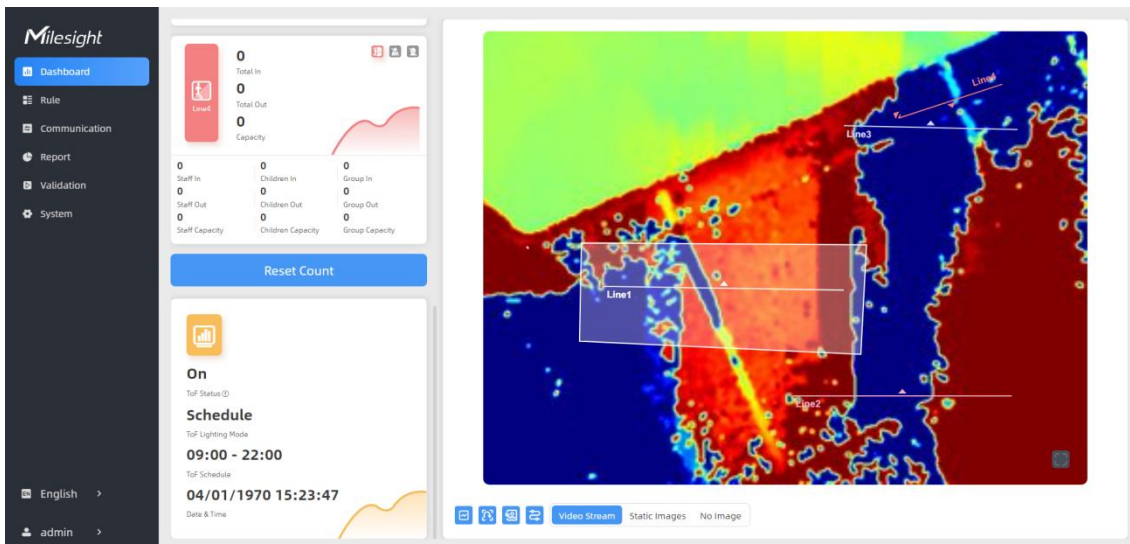
After logging on to the device web GUI successfully, user is allowed to view live video as follows.



Parameters	Description
	<p>Hide Capacity: Hide the total count data capacity;</p> <p>Staff Excluded: Exclude staff data from statistical data;</p> <p>Children Excluded: Exclude children data from statistical data.</p>
Reset Count	Clear all accumulated entrance and exit people counting values.

	<p>Click to show detection lines, U-turn areas, detection regions, tracking lines as needed.</p> <p>Note: These functions will not be shown here when they are disabled in Rule Configuration.</p>
<p>Scence Preview</p>	<p>Select video stream preview, static image preview or no image preview as needed.</p>

5.2 Rule

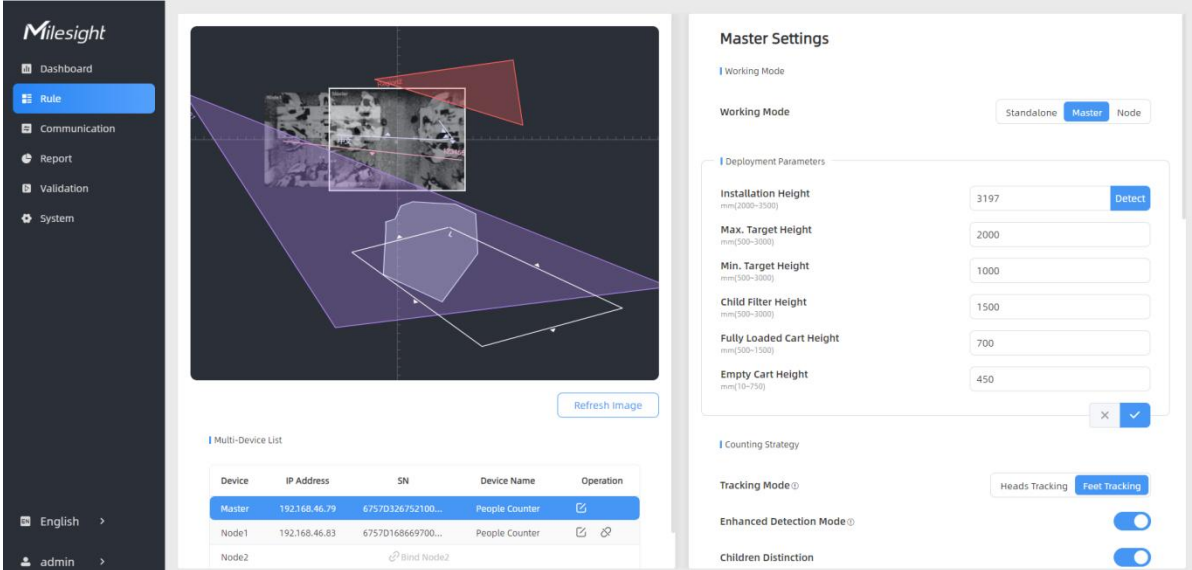

Master Settings

Working Mode: Standalone **Master** Node

Deployment Parameters:

- Installation Height: 3197
- Max. Target Height: 2000
- Min. Target Height: 1000
- Child Filter Height: 1500
- Fully Loaded Cart Height: 700
- Empty Cart Height: 450

Counting Strategy:

Tracking Mode: Heads Tracking **Feet Tracking**

Enhanced Detection Mode:

Children Distinction:

Multi-Device List:

Device	IP Address	SN	Device Name	Operation
Master	192.168.46.79	67570326752100...	People Counter	
Node1	192.168.46.83	67570168669700...	People Counter	
Node2			Bind Node2	

Draw Detection Lines

Users can draw detection lines to record the people count values which indicate the number of people enter or exit.

Step 1: Click **Draw Detection Lines**.

Step 2: Left-click to start drawing and drag the mouse to draw a line, left-click again to continue drawing a different direction edge and right-click the mouse to complete the drawing. The line can be dragged to adjust the location and length. One device supports at most 4 broken lines with maximum 4 segments each.

Step 3: If users need to delete the line, click **Draw Detection Lines** and select the line which need to be deleted, then click **Clear This Line** or click **Clear All**.

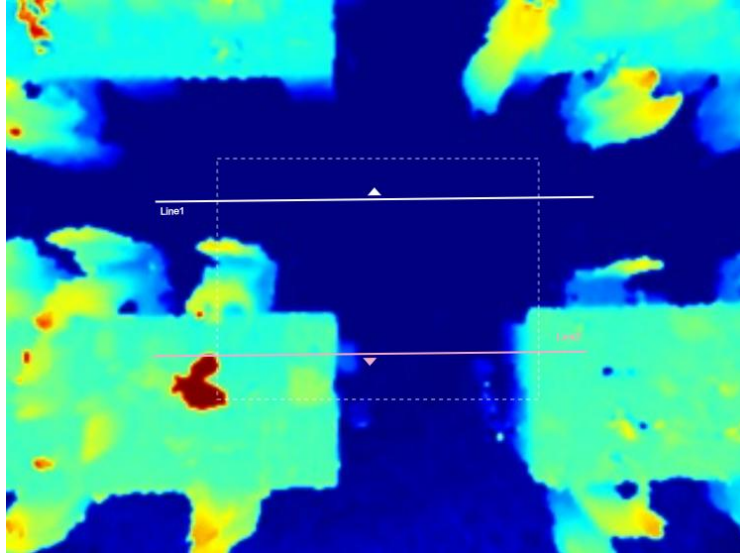
**Note:**

1) The arrow direction of the detection line depends on your drawing direction. If users need to flip the line, select the line which need to be flipped and click Flip Arrow Direction. And users can click Flip All to flip all detection lines.

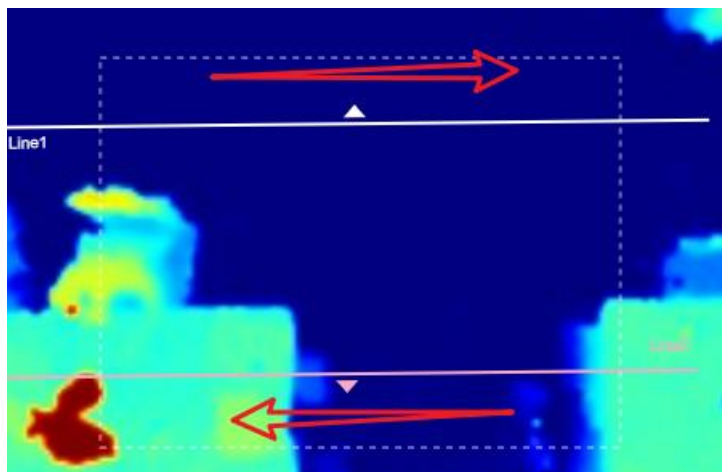

- 2) Ensure that the detected target can pass through the detection line completely. It's recommended that the detection line is perpendicular to the In/Out direction and on the center of the detection area without other objects around.
- 3) A redundant identification area needed to be left on both sides of the detection line for the target. This is to ensure that the sensor has stable recognition and tracking of this target before it passes the detection line, which will make the detection and count more accurate.

Rule Configuration

Users can set the rules to ensure accurate counting.

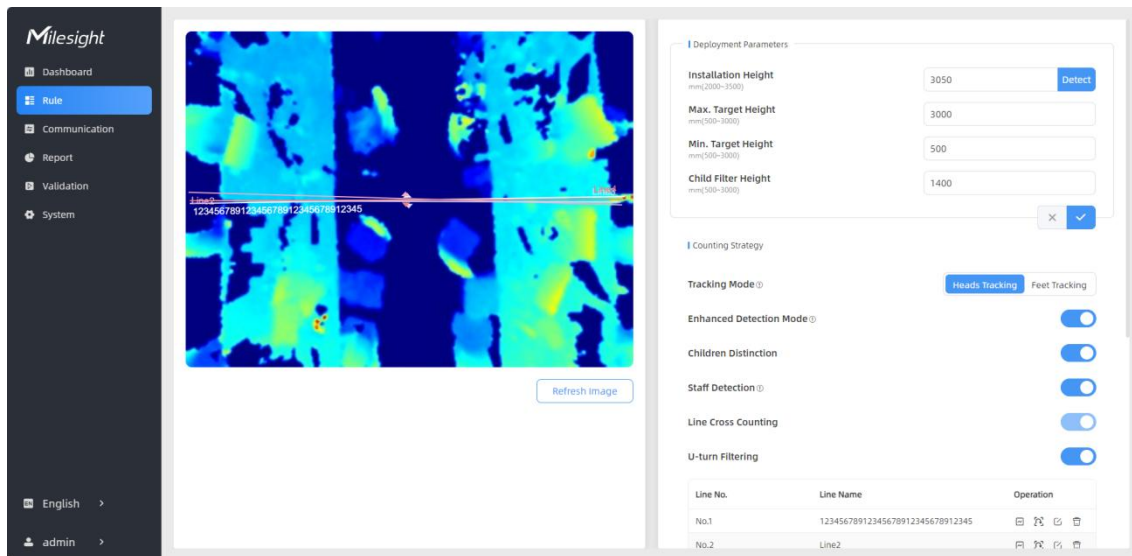

Parameters	Description
Installation Height	Set the device installation height. Click Detect to detect the current installation height automatically. Note: 1) Ensure that there are no objects directly below the device avoiding interfering the height detection. 2) The automatic detection of the installation height is not supported with dark floor/carpet (black, grey, etc.)
Max. Target Height	Set the maximum target height, then the device will ignore the objects higher than this setting value.
Min. Target Height	Set the minimum target height, then the device will ignore the object shorter than this setting value.
Tracking Mode	Select the tracking mode of counting, including Heads Tracking and Feet Tracking. Note: It is recommended to use heads tracking mode when the installation height is low in standalone working mode.
Enhanced Detection Mode	Turn on when any one of the following situations occurs, it will ensure normal counting and detecting: <ul style="list-style-type: none"> The depth image is abnormal; There is obstacle in the live view; Installation conditions are not met.
Children Distinction	The device will detect the people shorter than child filter height as children.
Staff Detection	The device will detect the people who wear reflective stripes as staff tags on the visible parts (neck, shoulders, etc.) as staffs. Reflective stripe requirements: width > 2cm, 500 cd/lux.m ²
U-turns Filtering	When enabled, it allows to draw an area for every line and the device will count the In and Out values only when people pass this area. Users can left-click to start the drawing and add edges for this area, then right-click to

stop drawing.

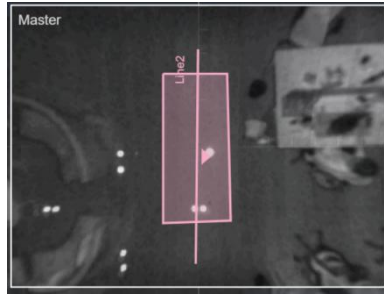

Click "+Add" to add the U-turn filtering. Up to 4 regions are supported with maximum 4 segments each.

Line No.	Line Name	Operation
No.1	L	
No.2	123456	
No.3	中文	
+Add		

You can edit the detection line, U-turn area, line name and delete line by click the buttons.

Group Counting

Click to enable the group counting function that based on the distance, moving direction and speed difference to gain deeper insights into customer' behaviors.

Note:

- 1) This function is only applicable for line cross people counting.
- 2) Only report group counting data when group counting function is enabled.

Region Monitoring

Click "+Add" to add the region monitoring. Up to 4 regions are supported with maximum 10 segments each.

Step 1: Draw the region monitoring areas on the screen.

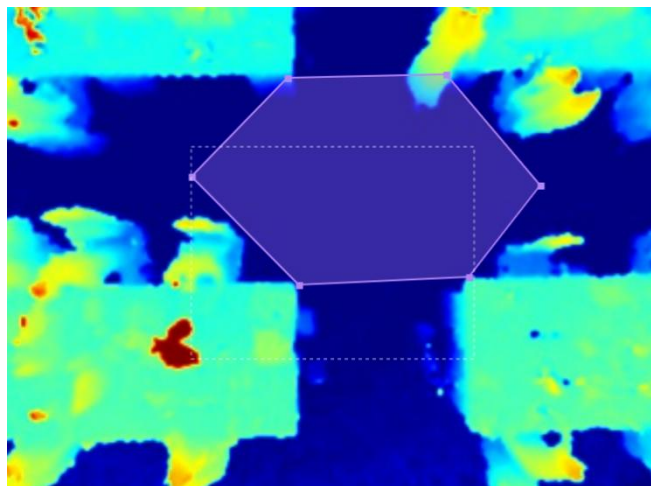

Step 2: You can customize the zone name. And click to enable Region People Counting and Dwell Time Detection as needed. Pass-by Filtering can be set to improve statistical accuracy and Min.Dwell Time can be set to improve statistical validity.

Advanced Properties

Zone Name

Region People Counting

Pass-by Filtering
s(0-3600)

Dwell Time Detection

Min. Dwell Time
s(0-3600)

Step 3: The configuration is displayed in the list after the configuration is complete. You can redraw the areas by clicking the redraw button in the list. And click the edit button to modify the advanced settings of the areas or click delete button to delete the areas separately.

No.	Region Name	Advanced Properties	Operation
No.1	Region1	Region People Counting(5s)	<input checked="" type="checkbox"/> <input type="button" value="edit"/> <input type="button" value="delete"/>
+ Add			

Reset Cumulative Count on Schedule	Enable to periodically reset cumulative count on schedule. Cumulative Count includes: Total In/Out counting of each detection line. Max./Avg. Dwell Time of each detection region.
Periodic Report	Report the people counting data periodically.
Period	Set the period of reporting periodic report. Range: 1-1080 mins, default: 10 mins
Trigger Report	Report immediately when there is a change of the line cross people counting number or region people counting number.

Note:

Due to the error in ToF distance measurement (0.035 m), the Max. Target Height should be set as maximum pedestrian height plus 0.035 m and the Min. Target Height as minimal pedestrian height minus 0.035 m in the actual applications. For example, if the pedestrian height is 1.6 m to 1.8 m, the Max. and Min. Target Height should be configured as 1.835 m and 1.565 m respectively.

5.3 Communication

5.3.1 WLAN

VS133 supports wlan feature to work as AP mode to configure device and it can not connect to other access point.

Parameters	Description
Enable WLAN	Enable or disable Wi-Fi feature. If disabled, users can use button or LoRaWAN® downlink command to enable it.
Wi-Fi SSID	The unique name for this device Wi-Fi access point.
WLAN IP Address	Configure WLAN IP address for web access, the default IP address is 192.168.1.1.
Protocol	802.11b (2.4 GHz), 802.11g (2.4 GHz), 802.11n (2.4 GHz) are optional.
Bandwidth	20 MHz or 40 MHz are optional.
Channel	Select the wireless channel. Auto, 1,...11 are optional.
Security Mode	No Encryption, WPA-PSK, WPA2-PSK and WPA-PSK/WPA2-PSK are optional.
Cipher	AES, TKIP, AES/TKIP are optional.
Wi-Fi Password	Customize the password when security mode is not No Encryption.

5.3.2 LoRa

LoRa settings are used for configuring the transmission parameters in LoRaWAN® network.

Device LoRa Info.

LoRa Status De-activated

Device EUI 24E1246936202833

LoRaWAN® Settings

APP EUI

Application Port
(1~223)

Join Type

Application Key

Rejoin Mode

Number of Detection
(4~32)

LoRaWAN® Version

Region

RX2 Data Rate

RX2 Frequency
MHz(923.3~927.5)

Spreading Factor

Enabled Channel Index

Channel List

Index	Frequency <small>MHz</small>
0-15	902.3-905.3
16-31	905.5-908.5
32-47	908.7-911.7
48-63	911.9-914.9
64-71	903-914.2

LoRa Working Mode

Confirm Mode

ADR

Parameters	Description
------------	-------------

LoRa Status	LoRaWAN [®] network joining status of this device.
Device EUI	Unique ID of the device, which can also be found on the label.
App EUI	The Default App EUI is 24E124C0002A0001.
Application Port	The port used for sending and receiving data, default port is 85.
Join Type	OTAA and ABP mode are available.
Application Key	Appkey for OTAA mode, the default key is 5572404C696E6B4C6F52613230313823.
Device Address	DevAddr for ABP mode, the default address is the 5 th to 12 th digits of SN.
Network Session Key	Nwkskey for ABP mode, the default key is 5572404C696E6B4C6F52613230313823.
Application Session Key	Appskey for ABP mode, the default key is 5572404C696E6B4C6F52613230313823.
Rejoin Mode	<p>Reporting interval \leq 35 mins: the device will send a specific number of LinkCheckReq MAC packets to the network server every reporting interval or every double reporting interval to validate connectivity; If there is no response, the device will re-join the network.</p> <p>Reporting interval $>$ 35 mins: the device will send a specific number of LinkCheckReq MAC packets to the network server every reporting interval to validate connectivity; If there is no response, the device will re-join the network.</p>
Number of Detection	<p>When rejoin mode is enabled, set the number of detection.</p> <p>Note: the actual sending number is Number of Detection + 1.</p>
LoRaWAN [®] Version	V1.0.2, V1.0.3 are available.
Region	Frequency plan of this device.
RX2 Data Rate	RX2 data rate to receive downlinks.
RX2 Frequency	RX2 frequency to receive downlinks.
Spreading Factor	If ADR is disabled, the device will send data via this spreading factor.
Channel	<p>Select the channel from channel list or enter the index to select the frequency channel.</p> <p>Index examples:</p> <p>1, 40: Enabling Channel 1 and Channel 40</p> <p>1-40: Enabling Channel 1 to Channel 40</p> <p>1-40, 60: Enabling Channel 1 to Channel 40 and Channel 60</p> <p>All: Enabling all channels</p>

	Null: Indicates that all channels are disabled
Confirm Mode	If the device does not receive ACK packet from network server, it will resend data once.
ADR	Allow network server to adjust data rate of the device.

Note:



- 1) Please contact sales for device EUI list if there are many units.
- 2) Please contact sales if you need random App keys before purchase.
- 3) Only OTAA mode supports rejoin mode.
- 4) Select OTAA mode when you connect device to Milesight IoT Cloud.

5.4 Report

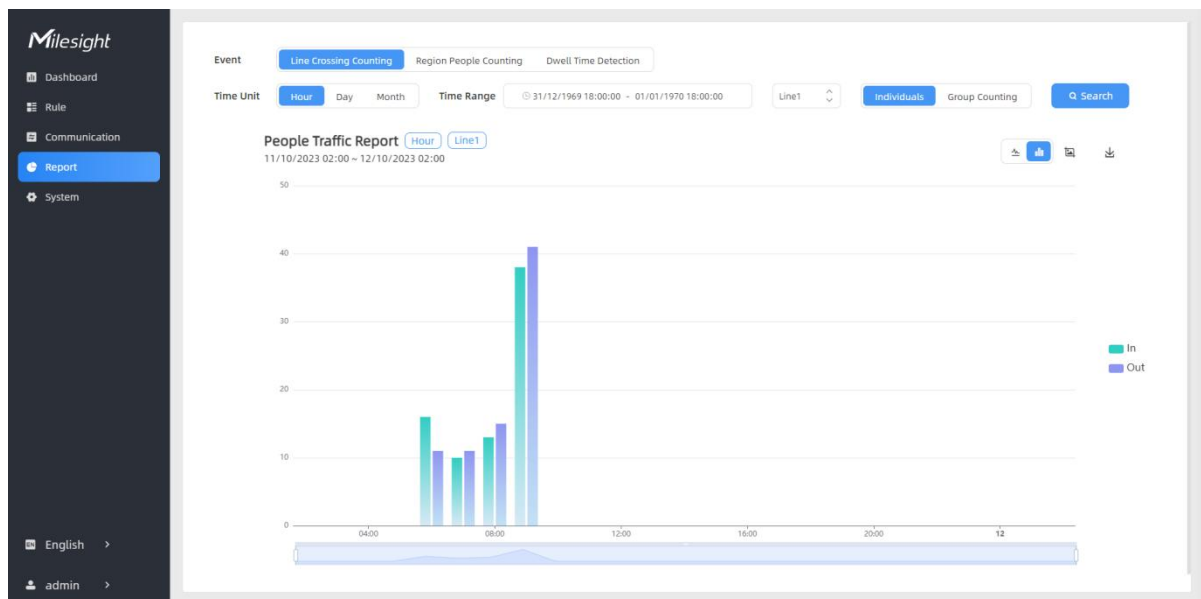
VS133 supports to visual line chart or bar chart generation to display people traffic and supports report exporting. Before using this feature, ensure that the device time is correct on **System** page.



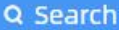

Parameters	Description
Event	Select the event which you want to query the report. Line crossing counting, region people counting and dwell time detection are optional.
Time Unit	Select the unit to generate the graph or export the data.
Time Range	Select the time range to generate the graph.
Line1	Select the line to display the graph.
Individuals Groups	Select the individuals counting reports or groups counting reports.
Region1	Select the region to display the graph.

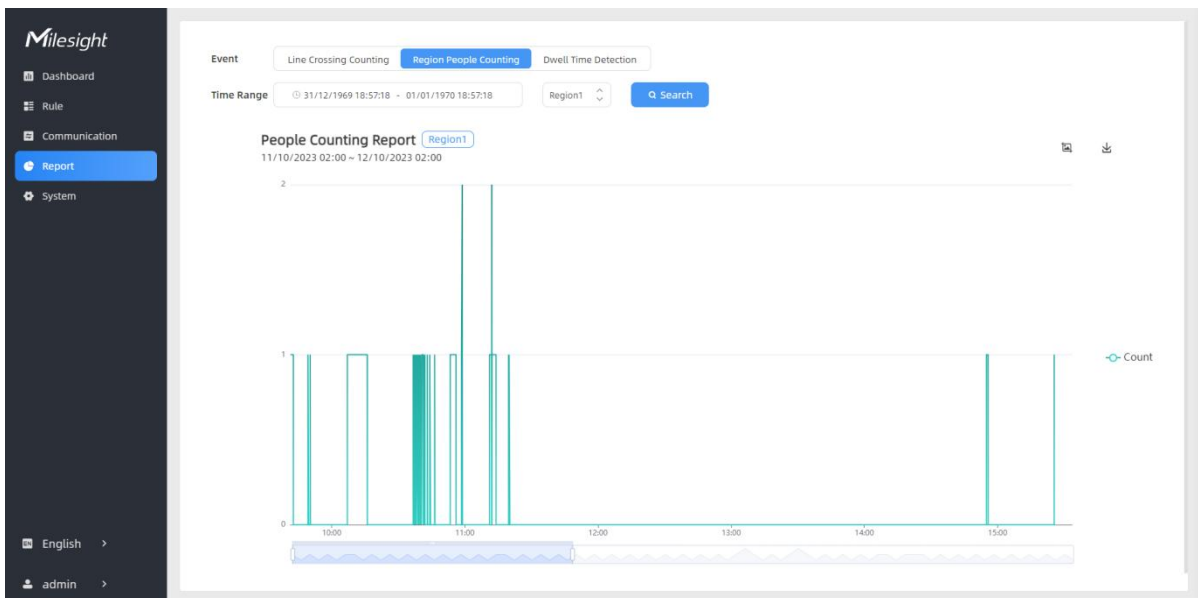
	Click to generate the graph according to the time range and line option.
Export	Export the historical traffic data as CSV file according to the selected time unit. The device can store up to one million data records to CSV file.
Staff Included/Excluded	Select whether to contain staff counting values on the graph.
	Select the display type as line or bar.
	Download the graph screenshot.



5.5 Validation

Video validation function can assist users in verifying the accuracy of people counting by setting up a video recording task.

Task Name	Start Time	End Time	Duration min	Task Status	Operation
Task 1	2024-03-13 08:30:00.000	2024-03-13 09:00:00.000	30	Finished	 

+Add

Parameters	Description
Task Name	Show the task name.
Start/End Time	Show the start time and end time of this video.
Duration	Show the length of the video.
Task Status	Show the video task status.
Operation	Click to check the video details, stop recording or delete the task.
+Add	Click to add a video task. One device can add up to 12 tasks.

Set a Task of Recording

Task Name

Recording Mode

Start Time

Duration
min(1~60)





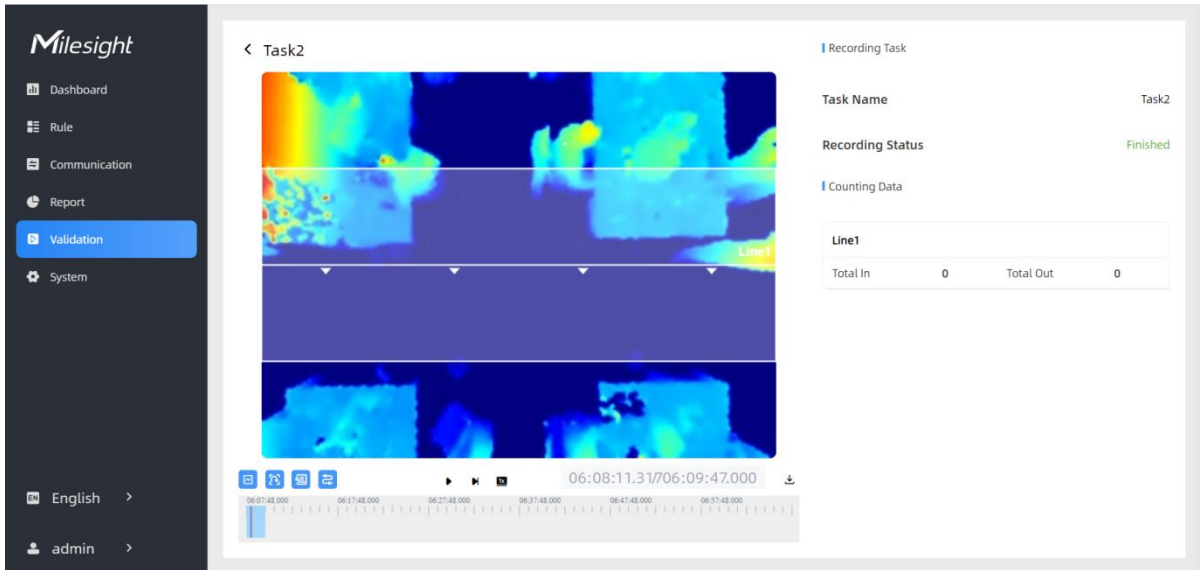

Video Quality

Parameters	Description
Task Name	Customize a name for this task.
Recording Mode	Record Now or Setting Time is optional.
Start Time	Set the start recording time.
Duration	Set the duration of the recording, the duration of all tasks should not be more than 60 minutes.
Video Quality	When video quality is low, the video size will be smaller and quicker to download.

Note:

- The setting time range of different tasks can not be overlap.
- Detection rules and ToF frequency parameters cannot be modified during the recording process.
- If the validation videos need to be played locally, please contact Milesight IoT support for a specialized player.



Parameters		Description
Video Task	Start Recording	Clicking Start Recording to initiate the recording task. You can manually click Stop Recording to end the recording, or it will automatically stop when the recording time reaches 60 minutes.
	Set a Task of Recording	Configure the start time and duration of the recording. The duration can be set from 1 to 60 minutes. Clicking Cancel Task manually will cancel the recording schedule. <div data-bbox="639 1133 1099 1370" style="border: 1px solid #ccc; padding: 5px; margin: 5px 0;"> <p>Set a Task of Recording</p> <p>Start Time <input type="text" value="05/12/2023 16:22:39.000"/></p> <p>Duration <input type="text" value="60"/> min(1-60)</p> <p style="text-align: right;"><input type="button" value="x"/> <input type="button" value="✓"/></p> </div>
Playback Button		Enable/Disable detection lines in the recording footage.
		Enable/Disable u-turn area in the recording footage.
		Enable/Disable detection region in the recording footage.
		Enable/Disable tracking line in the recording footage.
		Rewind/Pause/Play/Forward(supports switching between 0.5x, 1x, 2x, and 4x playback speed).
		Start time and end time of the recording.
		Download video stream footage.

Note: The playback progress bar of video stream footage highlights the video frame where the data changes.

5.6 System

5.6.1 Device Info

All information about the hardware and software can be checked on this page.

Device Info.

Device Name	People Counter	<input type="button" value="x"/> <input type="button" value="v"/>
Product Model	VS133-915M	
SN	6757D13928710005	
Hardware Version	V1.0	
Software Version	V_133.1.0.1-b-t14	
MAC Address	24:E1:24:FF:00:04	

5.6.2 User

Users

Username	User Level	Operation
admin	Administrator	<input type="checkbox"/> <input type="checkbox"/>
+ Add User		

Parameters	Description
<input type="checkbox"/>	You can change the login password of this device.

Users modify

Username	<input type="text" value="admin"/>
User Level	<input type="text" value="Administrator"/>
Administrator Password	<input type="password"/>
New Password	<input type="password"/>
Confirm	<input type="password"/>

At least:

- 8 characters
- 2 types of characters: Number, letter and symbol



Click to set three security questions for your device. In case that you forget the password, you can click **Forget Password** button on login page to reset the password by answering three security questions correctly.

Secure Question Settings Already Set

Password	<input type="password"/>
Security Question1	<input type="text" value="What is your lucky number?"/>
Answer1	<input type="text"/>
Security Question2	<input type="text" value="What is your favorite sport?"/>
Answer2	<input type="text"/>
Security Question3	<input type="text" value="What is your favorite game?"/>
Answer3	<input type="text"/>



Click to add a viewer, who will only have access to the "Dashboard" and "Report" interfaces.

Add User

Username	<input type="text" value="viewer"/>
User Level	<input type="text" value="Viewer"/>
Password	<input type="password"/>
Confirm	<input type="password"/>

At least:

- 8 characters
- 2 types of characters: Number, letter and symbol



+ Add User

5.6.3 Time Configuration

Current System Time

Date 01/08/2023

Time 05:36:15

Set the System Time

Time Zone UTC-0:00 Western European Time (WET), Greenwich Me ⌵

Daylight Saving Time

Start Time May. ⌵ Last ⌵ Sun. ⌵ 02:00 ⌵

End Time Oct. ⌵ Last ⌵ Sun. ⌵ 03:00 ⌵

DST Bias min 60 ⌵

Synchronize Time

Setting Time 01/08/2023 05:35:03

Synchronize with your computer time

Parameters	Description
Time Zone	Choose the time zone for your location.
Daylight Saving Time	Enable or disable Daylight Saving Time (DST). Start Time: the start time of DST time range. End Time: the end time of DST time range. DST Bias: the DST time will be faster according to this bias setting.
Setting Time	Set the device time manually.
Synchronize with computer time	Synchronize the time with your computer.

5.6.4 System Maintenance

Time of Flight Advanced Settings

Frequency Adjustment

Modulation Mode A

ToF Lighting Mode

Always On

Schedule

Schedule Settings

🕒 09:00 - 22:00

✕

✓

ToF Noise Filtering



Noise Filtering Level ⓘ

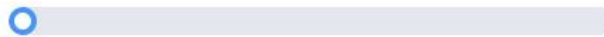

Reset

Recovery device basic configuration

Basic Recovery

Recovery device to factory settings

All Recovery

Reboot

Reboot the Device

Reboot

Upgrade

Software Version

V_133.1.0.6

Upgrade Image



Upgrade

Explanation: The upgrade process takes 1-10 minutes, do not turn off the power. The automatic reboot will happen once the upgrade complete.

Backup and Restore

Export Config File

Export

Import Config File



Import

Parameters

Description

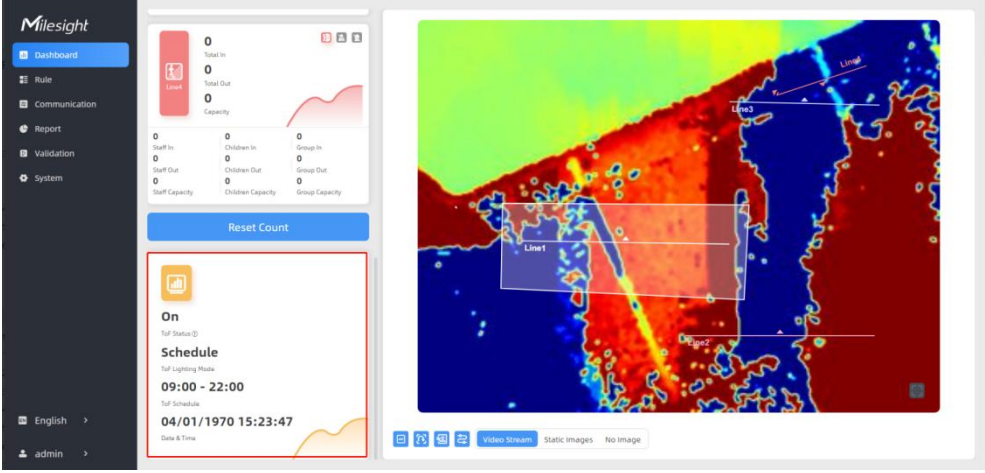
Frequency Adjustment	<p>Adjust the ToF frequency modulation mode to avoid the interference of surrounding IR devices. Please avoid using the same mode if there are multiple VS133 devices around.</p> <p>Note: if there is only one option, please contact Milesight IoT support: iot.support@milesight.com</p>
ToF Lighting Mode	<p>Adjust the ToF light mode as Always On or Schedule. When using Schedule mode, the device will only turn on the ToF light during scheduled time range to save power.</p> <p>Note:</p> <ol style="list-style-type: none"> 1) ToF light off will not affect the periodic report. 2) During validation, the ToF lighting will be fixed as On irregardless of its lighting mode configuration. 3) When using ToF Lighting Mode, the Dashboard will display relevant information.  <p>The screenshot shows the Milesight dashboard interface. On the left is a navigation menu with options: Dashboard, Rule, Communication, Report, Validation, and System. The main content area is divided into three sections. The top section displays various statistics: Total In, Total Out, Capacity, Staff In, Children In, Group In, Staff Out, Children Out, and Group Out, each with a corresponding counter and a small line graph. Below this is a 'Reset Count' button. The middle section shows the ToF lighting mode configuration, with a toggle set to 'On', a 'Schedule' section showing '09:00 - 22:00', and a 'ToF Schedule' section showing '04/01/1970 15:23:47'. The bottom section is a large heatmap visualization of the ToF sensor's field of view, showing a color-coded area with labels for 'Line1', 'Line2', and 'Line3'. At the bottom of the heatmap are controls for 'Video Stream', 'Static Images', and 'No Image'.</p>
ToF Noise Filtering	Filter the noisy point on the screen when working with dark floor or carpet.
Noise Filtering Level	When installing in a spacious environment with black carpet, it is recommended to set the strength to 2; when installing in a narrow environment with black carpet, it is recommended to set the strength to 10.
Reset	<p>Recovery device basic configuration: keep the IP settings and user information when resetting.</p> <p>Recovery device to factory settings: reset device to factory default, which needs to verify admin password.</p>
Reboot	Restart the device immediately.
Upgrade	<p>Click the folder icon and select the upgrading file, then click the Upgrade button to upgrade. The update is done when the system reboots successfully.</p> <p>Note: The upgrade process takes about 1-10 minutes. Do not turn off the power and complete automatic restart after the upgrade.</p>
Backup and Restore	<p>Export Config File: Export configuration file.</p> <p>Import Config File: Click the file icon and select the configuration file, click Import button to import configuration file.</p>

6. Installation Instruction

Parameter definition:

Parameters	Explanation	Value
H	Installation height	≤3.5 m
d	Minimum detection distance of VS133	0.5 m
Δd	Distance measurement error of VS133	0.035 m
h_{\max}	Maximum pedestrian height	Example 1.8 m
h_{\min}	Minimum pedestrian height	Example 1.7 m
α	ToF horizontal field of view angle	98°
β	ToF vertical field of view angle	80°
x	Length of detection range	
y	Width of detection range	

6.1 Installation Height

The maximum installation height is 3.5 m and the minimum installation height is $h_{\max}+d+\Delta d$. For example, when the maximum pedestrian height is 1.8 m, then the minimum installation height is $1.8+0.5+0.035=2.335$ m.

6.2 Covered Detection Area

The detection area covered by the device is related to the field of view angle of the device, the installation height and the target height. The length of the detection area is approximately $x=2.300 \times (H-h_{\min})$ and the width of the detection area is approximately $y=1.678 \times (H-h_{\min})$.

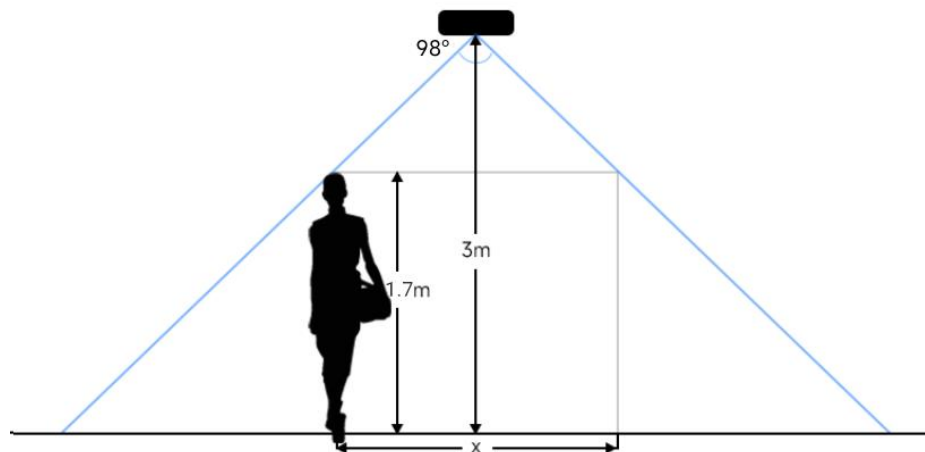

For example, if the Minimum height of pedestrians is 1.7 m, the detection area corresponding to each installation height is as follows:

Installation Height	FoV Monitored Area (m)	Detection Area (m)
2.5	5.75 × 4.20	1.84 × 1.34
2.6	5.98 × 4.36	2.07 × 1.51
2.7	6.21 × 4.53	2.30 × 1.68

2.8	6.44 × 4.70	2.53 × 1.85
2.9	6.67 × 4.87	2.76 × 2.01
3.0	6.90 × 5.03	2.99 × 2.18
3.1	7.13 × 5.20	3.22 × 2.35
3.2	7.36 × 5.37	3.45 × 2.52
3.3	7.59 × 5.54	3.68 × 2.69
3.4	7.82 × 5.71	3.91 × 2.85
3.5	8.05 × 5.87	4.14 × 3.02

6.3 Environment Requirements

- Dark floor/carpet (black, grey, etc.) will affect the device to count staffs when Staff Detection is enabled.

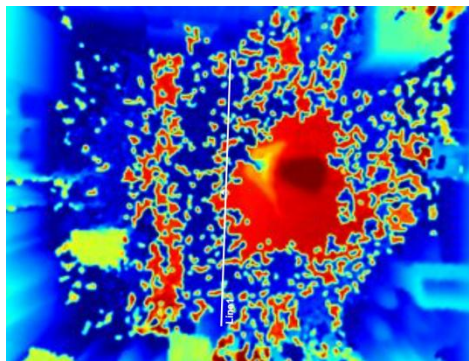

- Avoid 940nm light which may result in incorrect counting.
- Outdoor sunlight shining on the over channel will not have any effect, but the mirrored reflections that allow sunlight to shine on the ToF Sensor should be avoided.
- Make sure there are no obstacles within the live view of device. Otherwise, the device imaging may appear abnormally red or it will affect people counting. When the carpet/floor is black, make sure to adjust Noise Filtering Level to max value.

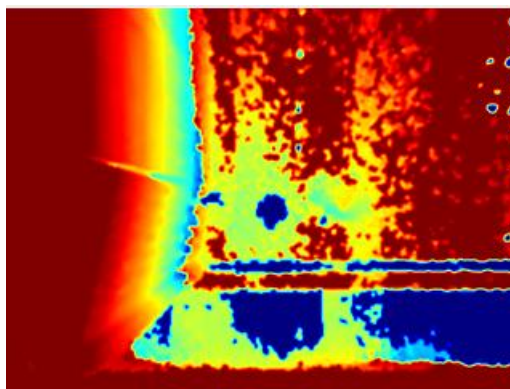

6.4 Installation

Ceiling Mount

Step 1: Ensure the thickness of the ceiling is more than 30 mm, rill 4 holes with a diameter of 6mm according to the mounting holes of device. If the wire needs to be extended to the interior of the ceiling, a wire hole with a suitable size is also required to be drilled.

Step 2: Fix the wall plugs into the ceiling holes.

Step 3: Remove the cover on the device, and then connect all required wires and pass them through the wire hole behind the device or block on the side of the device if the wires need to be protruded from the side of the device.

Step 4: Fix the device to the wall plugs via mounting screws; remember to adjust the mounting direction according to the detection area requirement.

Step 5: Fix the cover back to the device.

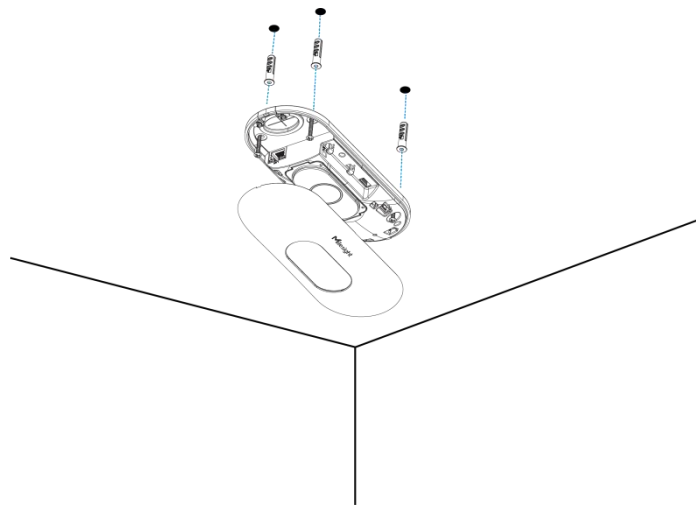

Ceiling/Lintel Mount (with Optional VB01 Multifunctional Bracket)

Step 1: Attach the mounting plate to the device with 4 screws.

Step 2: Fix the pole to the mounting plate with the hole on the plate.

Step 3: Adjust the length of the pole, then adjust the direction of 3-axis ball and tighten it with the handle.

Step 4: Determine the mounting location and drill 3 holes, fix the wall plugs into the mounting holes, then fix the bracket base to the wall plugs via mounting screws.

(Note: If the wire needs to be extended to the interior of the ceiling or wall, a wire hole with a suitable size is also required to be drilled.)

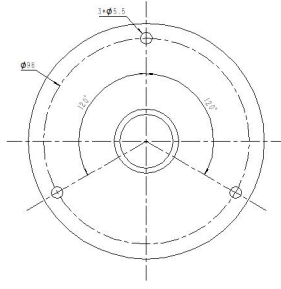

Step 5: Remove the cover on the device, and then connect all required wires and pass them through the inside of pole.

Step 6: Fix the pole to bracket base with screws and nuts.

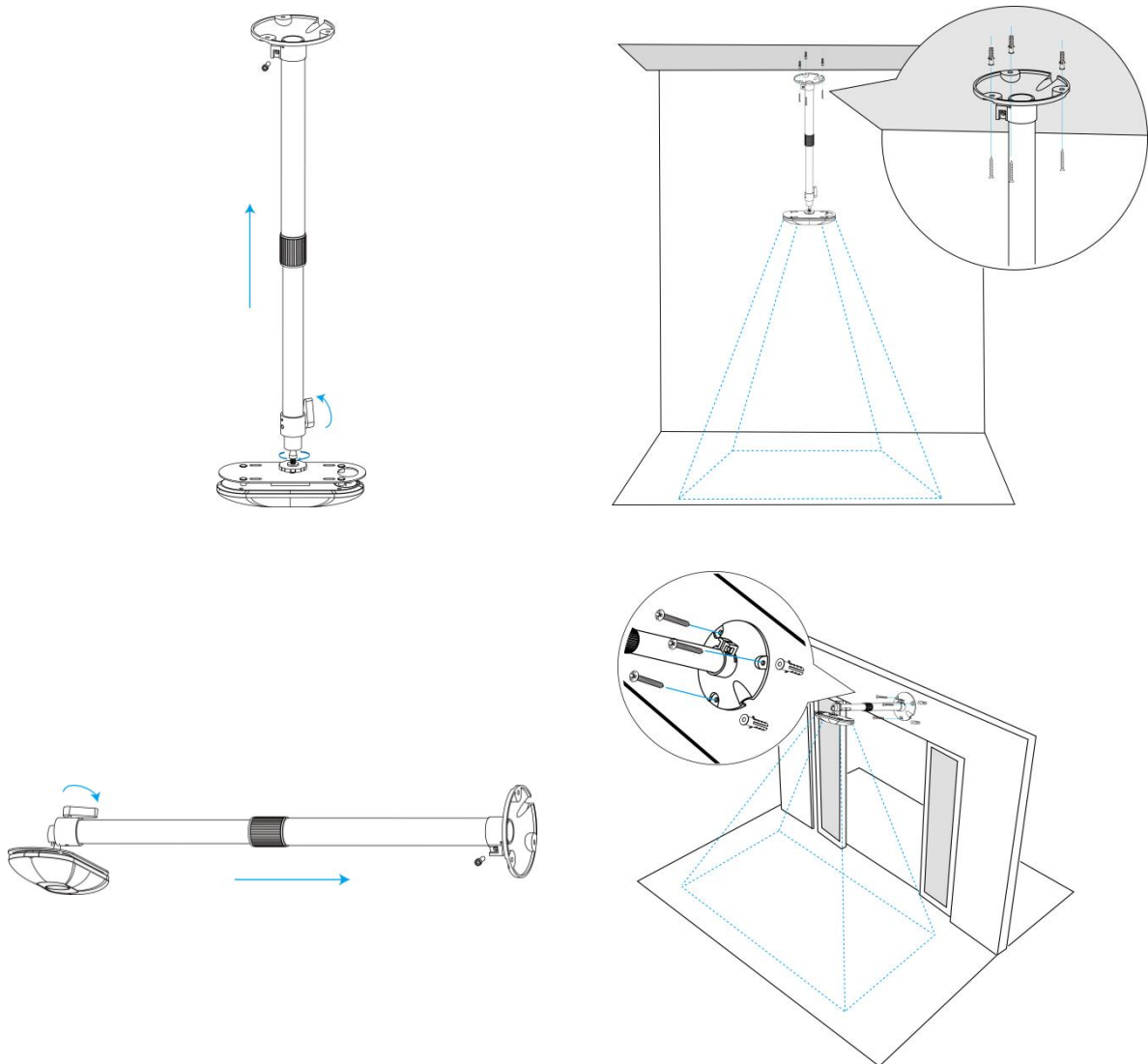

Note:

- Tilt installation should be avoided. Ensure that the front of the device and the ground plane are paralleled.
- Avoid installing the device against the wall and ensure that the distance between the device and the wall as follows:

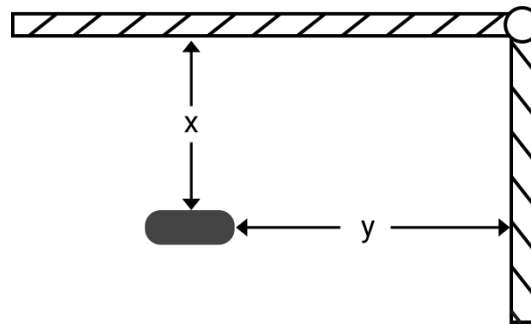

Condition	Standard Environment	The carpet/floor is Dark (need to set max noise filtering level)
Normal imaging	$x > 50\text{cm}, y > 60\text{cm}$	$x > 50\text{cm}, y > 75\text{cm}$
Normal counting	$x > 50\text{cm}, y > 50\text{cm}$	$x > 50\text{cm}, y > 50\text{cm}$

- Ensure that there are no other objects blocking the ToF light within a 30 cm radius of the front of the device.
- When you install devices on the top of swinging doors, it is suggested to keep the door normally open. If the door must be normally closed, please install the device on the other side of the door to keep away from the door movement. And it is suggested to keep away from the door with a distance of at least 30 cm.

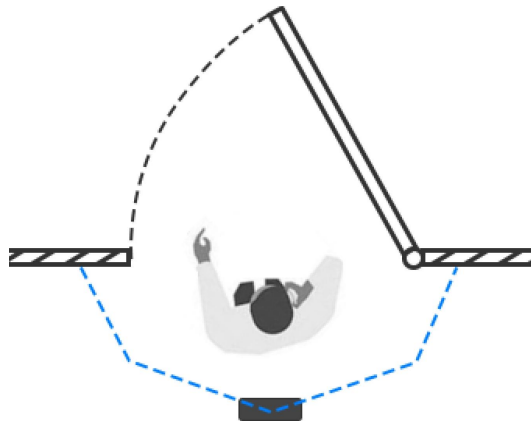

6.5 Factors Affecting Accuracy

- Wearing a fisherman's hat or carrying a cardboard box on the shoulder: The target will not be recognized because it will become unlike a human in depth map.
- Handheld or cart-carrying a humanoid doll with sufficient height to pass by: The doll will be mistakenly detected as people because it is human-like in depth map.

7. Communication Protocol

7.1 Uplink Data

VS133 reports basic information of sensor whenever joining the network and the number of people periodically. For decoder examples please find files on <https://github.com/Milesight-IoT/SensorDecoders>.

Channel	Type	Description
ff	01 (Protocol Version)	01=> V1
	09 (Hardware Version)	01 04 => V1.4
	16 (Device SN)	16 digits
	1f (Software Version)	85 01 00 05 => 133.1.0.5
03	d2 (Accumulated counter)	Line 1 accumulated in counter, 4 bytes
04	d2 (Accumulated counter)	Line 1 accumulated out counter, 4 bytes
05	cc (Periodic counter)	Line 1: Byte 1-2: in counter during the report interval Byte 3-4: out counter during the report interval
06	d2 (Accumulated counter)	Line 2 accumulated in counter, 4 bytes
07	d2 (Accumulated counter)	Line 2 accumulated out counter, 4 bytes
08	cc (Periodic counter)	Line 2: Byte 1-2: in counter during the report interval Byte 3-4: out counter during the report interval
09	d2 (Accumulated counter)	Line 3 accumulated in counter, 4 bytes
0a	d2 (Accumulated counter)	Line 3 accumulated out counter, 4 bytes
0b	cc (Periodic Counter)	Line 3: Byte 1-2: in counter during the report interval Byte 3-4: out counter during the report interval
0c	d2 (Accumulated counter)	Line 4 accumulated in counter, 4 bytes
0d	d2 (Accumulated counter)	Line 4 accumulated out counter, 4 bytes
0e	cc (Periodic Counter)	Line 4: Byte 1-2: in counter during the report interval Byte 3-4: out counter during the report interval
0f	e3 (Region Monitoring)	Byte 1: number of people in region 1 currently Byte 2: number of people in region 2 currently Byte 3: number of people in region 3 currently Byte 4: number of people in region 4 currently
10	e4 (Region Monitoring)	Byte 1: region ID

		Byte 2-3: avg. dwell time
		Byte 4-5: max. dwell time

Note: If children distinction feature or staff detection feature is enabled, the counter uplinks will minus children and staff. For example, if children distinction is enabled, the accumulated in counter=total in counter-children in, the accumulated out counter=total out counter-children out.

Example:

1. Device information.

ff0101 ff166600b09409760000 ff090102 ff1f85010001					
Channel	Type	Value	Channel	Type	Value
ff	01 (Protocol Version)	01 (V1)	ff	16(Device SN)	66 00 b0 94 09 76 00 00
Channel	Type	Value	Channel	Type	Value
ff	09 (Hardware version)	0102 (V1.2)	ff	1f (Software version)	85 01 00 01 (V133.1.0.1)

2. People counter periodic report.

03d2 05000000 04d2 0c000000 0fe3 0200000a 10e4 0108000b00 05cc 02000100					
Channel	Type	Value	Channel	Type	Value
03	d2 (accumulated in counter)	Line 1 In: 05 00 00 00 => 00 00 00 05=5	04	d2 (accumulated out counter)	Line 1 Out: 03 00 00 00 => 00 00 00 03=3
Channel	Type	Value			
0f	e3 (Region Monitoring)	02: number of people in region 1 currently 00: number of people in region 2 currently 00: number of people in region 3 currently 0a=>10: number of people in region 4 currently			
Channel	Type	Value	Channel	Type	Value
10	e4 (accumulated out counter)	01: Region 1 avg. dwell time: 08 00 => 00 08=8s max. dwell time: 0b 00 => 00 0b=11s	05	cc (Periodic Counter)	Line 1 In: 02 00 => 00 02 = 2 Line 1 Out: 01 00 => 00 01 =1

3. People counter trigger report.

04d2 11000000 0fe3 02000001		
Channel	Type	Value

04	d2 (Accumulated out counter)	Line1 Out: 11 00 00 00=> 00 00 00 11 = 17
Channel	Type	Value
0f	e3 (Region Monitoring)	02: number of people in region 1 currently 00: number of people in region 2 currently 00: number of people in region 3 currently 01: number of people in region 4 currently

7.2 Downlink Command

VS133 supports to configure the device via downlink commands. Application port is 85 by default.

Channel	Type	Description
	10 (Reboot)	ff (Reserved)
	03 (Reporting Interval)	2 Bytes, unit: s
	04 (Confirm Mode)	00: disable, 01: enable
ff	05 (LoRaWAN® Channel Mask)	Byte 1: Channel index range 01: 0-15 02: 16-31 03: 32-47 04: 48-63 05: 64-79 06: 80-95 Byte 2-3: indicate disable or enable via every bit, 0=disable, 1=enable
	40 (ADR)	00: disable, 01: enable
	41 (Application Port)	1 Byte, default is 85
	42 (Wi-Fi)	00: disable, 01: enable
	43 (People Counting Periodic Report)	00: disable, 01: enable
	44 (People Counting Trigger Report)	00: disable, 01: enable
	51 (Clear the accumulated counting)	ff (Reserved)

Note: After changing any parameter of LoRaWAN® settings, the device will re-join the network.

Example:

1. Disable Wi-Fi.

ff4200		
Channel	Type	Value
ff	42 (Wi-Fi)	00: disable

2. Set AU915 or US915 channel mask as 8-15.

ff0501ff00 ff05020000 ff05030000 ff05040000 ff05050000		
Channel	Type	Value
ff	05 (Set Channel Mask)	01: Channel index 0-15, ff00 => 8-15 is enabled 02-05: Channel index 16-79, 0000 => all disabled

3. Reboot the device.

ff10ff		
Channel	Type	Value
ff	10 (Reboot)	ff (Reserved)

4. Set reporting interval as 20 minutes.

ff03b004		
Channel	Type	Value
ff	03(Set Reporting Interval)	b0 04 => 04 b0 = 1200s =20 minutes

-END-