

# Ultra ToF People Counter

Featuring LoRaWAN®

**VS135**

User Guide



## Safety Precautions

Milesight will not shoulder responsibility for any loss or damage resulting from not following the instructions of this operating guide.

- ❖ Though the device is compliant with Class 1 (IEC/EN 60825-1:2014), please **DO NOT** look at the ToF sensor too close and directly.
- ❖ The device must not be disassembled or remodeled in any way.
- ❖ To avoid risk of fire and electric shock, do keep the product away from rain and moisture before installation.
- ❖ Do not place the device where the temperature is below/above the operating range.
- ❖ **Do not touch the device directly to avoid the scalds when the device is running.**
- ❖ The device must never be subjected to shocks or impacts.
- ❖ Make sure the device is firmly fixed when installing.
- ❖ Do not expose the device to where laser beam equipment is used.
- ❖ Use a soft, dry cloth to clean the lens of the device.

## Declaration of Conformity

VS135 is in conformity with the essential requirements and other relevant provisions of the CE, FCC, and RoHS.

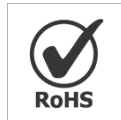

### Copyright © 2011-2024 Milesight. All rights reserved.

All information in this guide is protected by copyright law. Whereby, no organization or individual shall copy or reproduce the whole or part of this user guide by any means without written authorization from Xiamen Milesight IoT Co., Ltd.

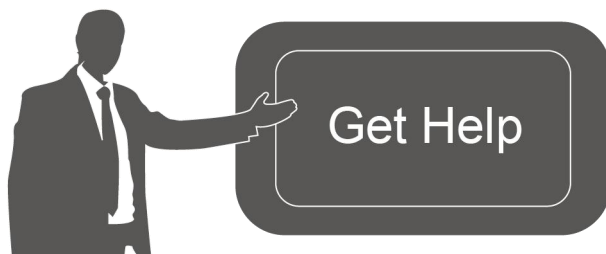

For assistance, please contact

Milesight technical support:

Email: [iot.support@milesight.com](mailto:iot.support@milesight.com)

Support Portal: [support.milesight-iot.com](http://support.milesight-iot.com)

Tel: 86-592-5085280

Fax: 86-592-5023065

Address: Building C09, Software Park  
Phase III, Xiamen 361024,  
China

## Revision History

Date	Doc Version	Description
Feb. 23, 2024	V1.0	Initial version
May 20, 2024	V1.1	<ol style="list-style-type: none"><li>1. Support to configure WLAN IP address;</li><li>2. Add ToF lighting mode and noise filtering;</li><li>3. Add validation record task list;</li><li>4. Add Enhanced Detection Mode;</li><li>5. Update installation distance.</li></ol>
Jul.30, 2024	V1.2	<ol style="list-style-type: none"><li>1. Add Multi-Device Stitching;</li><li>2. Add detection line list;</li><li>3. Add People Counting Trigger Report.</li></ol>

# Contents

1. Product Introduction .....	5
1.1 Overview .....	5
1.2 Key Features .....	5
2. Hardware Introduction .....	5
2.1 Packing List .....	6
2.2 Hardware Overview .....	6
2.3 Button and LED Indicators .....	6
2.4 Dimensions (mm) .....	7
3. Power Supply .....	7
4. Access the Sensor .....	7
5. Operation Guide .....	8
5.1 Dashboard .....	8
5.2 Rule .....	9
5.2.1 Basic Counting Settings .....	9
5.2.2 Multi-Device Stitching .....	15
5.3 Communication .....	22
5.3.1 WLAN .....	22
5.3.2 LoRa .....	23
5.4 Report .....	25
5.5 Validation .....	26
5.6 System .....	29
5.6.1 Device Info .....	29
5.6.2 User .....	29
5.6.3 Time Configuration .....	31
5.6.4 System Maintenance .....	31
6. Installation Instruction .....	34
6.1 Installation Height .....	34
6.2 Covered Detection Area .....	34
6.3 Environment Requirements .....	36
6.4 Installation .....	36
6.5 Factors Affecting Accuracy .....	40
7. Communication Protocol .....	40
7.1 Uplink Data .....	40
7.2 Downlink Command .....	42

# 1. Product Introduction

## 1.1 Overview

VS135 is a high-end people counting sensor that is based on deep learning AI and second-generation ToF technology. It is capable of adapting to various complex scenarios while ensuring excellent privacy protection. This sensor possesses an impressive accuracy of up to 99.8% in people counting, fully meeting your needs, and it delivers exceptional performance for both indoor and outdoor applications. With high ceiling mounting of up to 6.5m and an IP65 waterproof rating, it adapts seamlessly to any environment.

## 1.2 Key Features

- Up to 99.8% accuracy with the 2nd generation ToF technology and AI algorithm.
- Allow to collect more accurate people counting data by differentiating children / adults and detecting staffs via identification like staff lanyards for clearer people analysis.
- Smart U-turn detection to filter redundant counting of people wandering in the area.
- Support queuing management via dwell time detection and regional people counting.
- With radar sensor based ESG friendly working mode, it allows to experience full-speed operation when occupied while switching to a power-saving sleep mode when unoccupied.
- By incorporating 3-axis sensors for automatic height calibration, it ensures enhanced precision and guarantees accurate data analysis.
- Support automatic compensation of person height values when the device is mounted at a tilt.
- Working well even in low-light or completely dark environments with great lighting adaptability.
- Free from privacy concerns without image capturing.
- Store a million counting data locally and securely.
- Easy configuration via Wi-Fi for web GUI configuration.
- Function well with standard LoRaWAN® gateways and network servers.
- Quick and easy management with Milesight IoT Cloud.

# 2. Hardware Introduction

## 2.1 Packing List

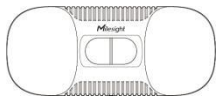

1 × VS135 Device



4 × Ceiling Mounting Kits



8 × Staff Tags

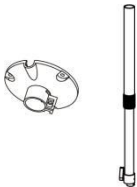

1 × VB01 Multifunctional Bracket Kit (Optional)

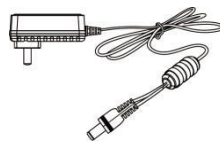

1 × Power Adapter



1 × Quick Guide



1 × Warranty Card

**!** If any of the above items is missing or damaged, please contact your sales representative.

## 2.2 Hardware Overview

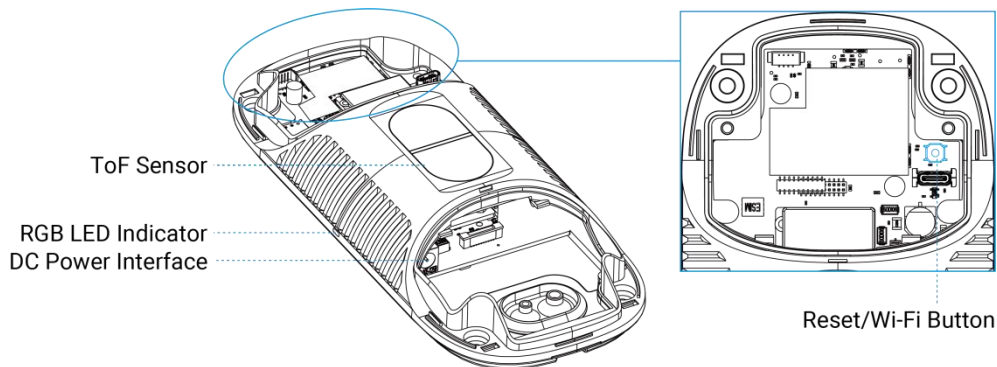

## 2.3 Button and LED Indicators

Function	Action	LED Indication
Turn On/Off Wi-Fi	Press and hold the power button for more than 3 seconds.	Turn On/Off: Blue light blinks for 3 seconds. Wi-Fi On: Blue light on. Wi-Fi Off: Green light on.
Reset to Factory Default	Press and hold the reset button for more than 10	Green light blinks until the reset process is completed.

seconds.

## 2.4 Dimensions (mm)

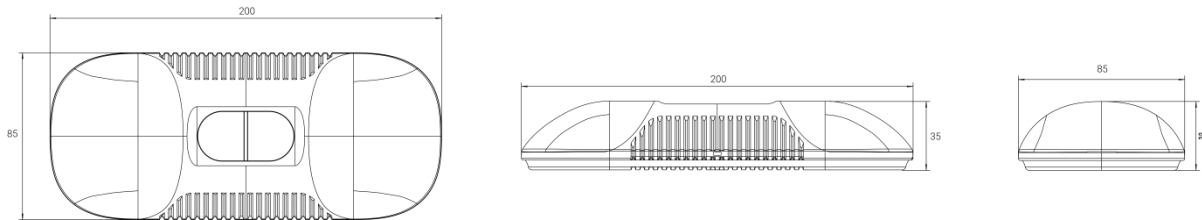

## 3. Power Supply

VS135 can be powered by power adapter (12V DC, 2A).

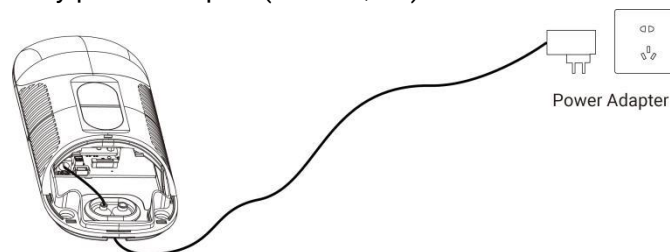

## 4. Access the Sensor

VS135 provides user-friendly web GUI for configuration access via Wi-Fi. Users need to customize the password when using the device for the first time. The default settings are as below:

**Wi-Fi SSID:** People Counter\_xxxxxx (can be found on the device label)

**Wi-Fi IP:** 192.168.1.1

Here are the wireless method way of accessing the web GUI:

**Step 1:** Enable the Wireless Network Connection on your computer, search for corresponding Wi-Fi SSID to connect it, then type 192.168.1.1 to access the web GUI.

**Step 2:** Select the language.

**Step 3:** Users need to set the password and three security questions when using the sensor for the first time (three questions can be skipped by refreshing webpage). After configuration, log in with username (admin) and custom password.

**Note:**

- 1) Password must be 8 to 16 characters long, which contains at least two kinds or more in combination with numbers, lowercase letters, uppercase letters and special characters .
- 2) You can click the "forgot password" in login page to reset the password by answering three

security questions when you forget the password if you set the security questions in advance.

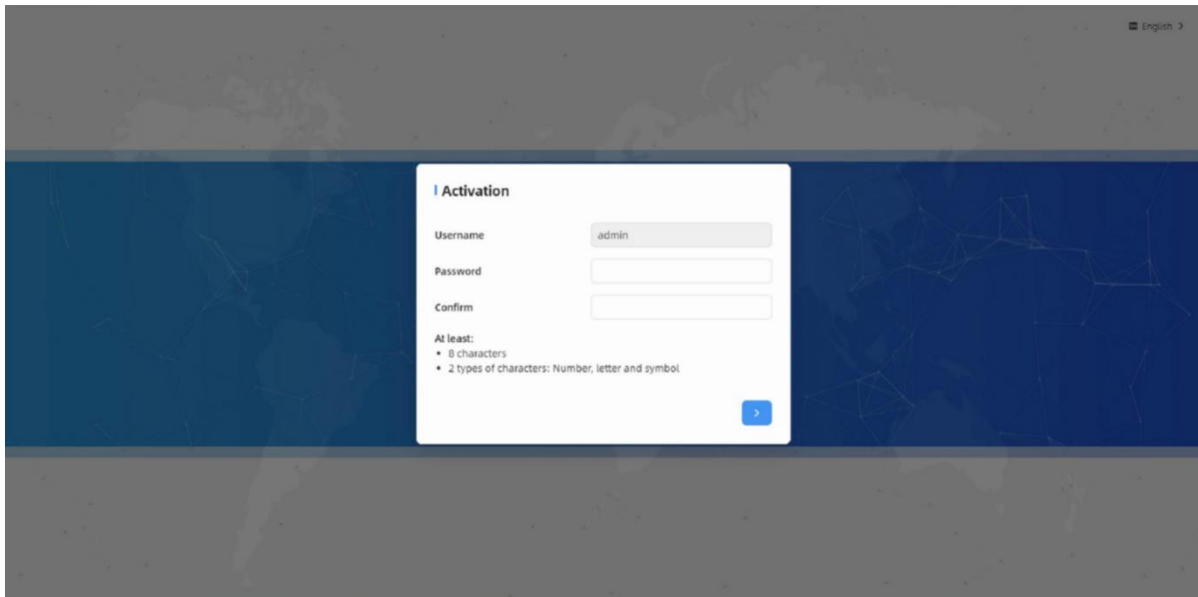

The screenshot shows a web interface with a dark blue background and a white modal window titled "Activation". The modal contains the following fields and text:

- Username:** A text input field containing the value "admin".
- Password:** A text input field.
- Confirm:** A text input field.
- At least:**
  - 8 characters
  - 2 types of characters: Number, letter and symbol
- A blue button with a right-pointing arrow.

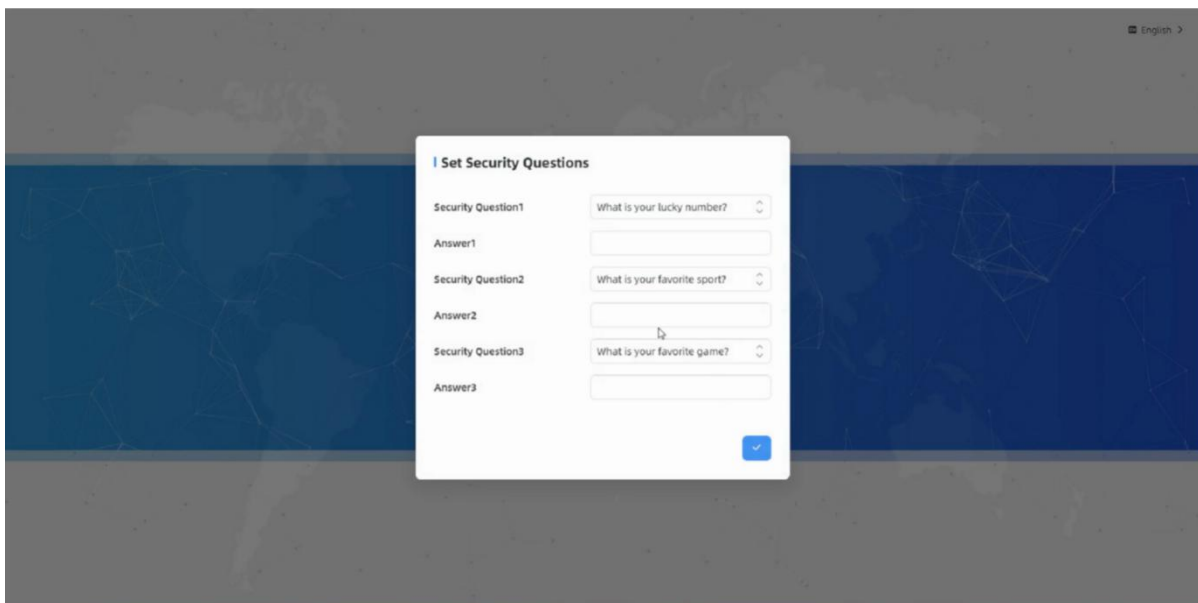

The screenshot shows a web interface with a dark blue background and a white modal window titled "Set Security Questions". The modal contains the following fields and text:

- Security Question1:** A dropdown menu with the selected option "What is your lucky number?".
- Answer1:** A text input field.
- Security Question2:** A dropdown menu with the selected option "What is your favorite sport?".
- Answer2:** A text input field.
- Security Question3:** A dropdown menu with the selected option "What is your favorite game?".
- Answer3:** A text input field.
- A blue button with a checkmark.

## 5. Operation Guide

### 5.1 Dashboard

After logging on to the device web GUI successfully, user is allowed to view live video as following.

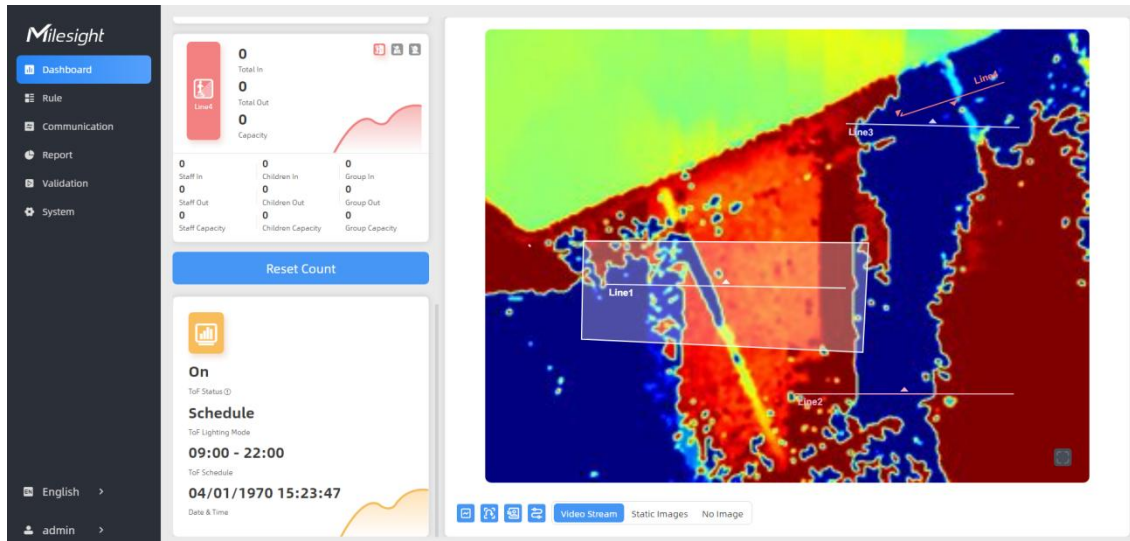

Parameters	Description
	<p><b>Hide Capacity:</b> Hide the total count data capacity;</p> <p><b>Staff Excluded:</b> Exclude staff data from statistical data;</p> <p><b>Children Excluded:</b> Exclude children data from statistical data.</p>
Reset Count	Clear all accumulated entrance and exit people counting values.
	<p>Click to show detection lines, U-turn areas, detection regions, tracking lines as needed.</p> <p><b>Note:</b> These functions will not be shown here when they are disabled in <a href="#">Rule Configuration</a>.</p>
Scence Preview	Select video stream preview, static image preview or no image preview as needed.

## 5.2 Rule

### 5.2.1 Basic Counting Settings

#### Draw Detection Lines

Users can draw detection lines to record the people count values which indicate the number of people enter or exit.

**Step 1:** Find the list of detection lines. Click **+Add** to draw a new detection line or click  to edit existed detection line on the live view.

Line Cross Counting

U-turn Filtering

Line No.	Line Name	Operation
No.2	Line2	
No.3	Line3	
No.4	Line4	
+Add		

**Step 2:** Left-click to start drawing and drag the mouse to draw a line, left-click again to continue drawing a different direction edge, and right-click the mouse to complete the drawing. The line can be dragged to adjust the location and length. One device supports at most 4 broken lines with maximum 4 segments each.

**Step 3:** If users want to redraw this line, click **Clear This Line** or drag the vertices of the broken line to adjust. The arrow direction of the detection line depends on your drawing direction. If

users need to flip the line, click **Flip Arrow Direction**. Then click  to finish drawing.

**Note:**

- 1) Ensure that the detected target can pass through the detection line completely. It's recommended that the detection line is perpendicular to the In/Out direction and on the center of the detection area without other objects around.
- 2) Redundant identification spaces are needed on both sides of the detection line for the target detection. It ensures the stable recognition and tracking of the target before passing the detection line, which will make the detection and count more accurate.

## Draw U-turn Area

VS135 supports the U-turn filtering function, filtering out the people who are actually not in / out of the entrance, to avoid repeated counting. Users can draw an area for every line and the device will count the In and Out values only when people pass this area.

**Disable U-turn filtering:**

**Enable U-turn filtering:**

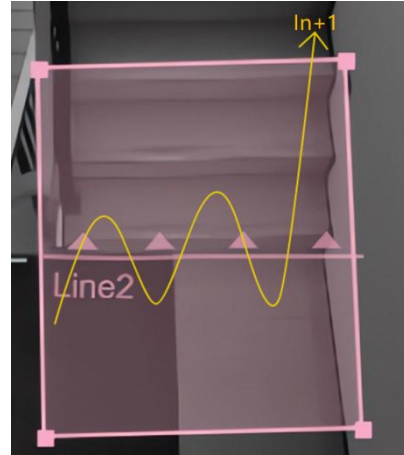
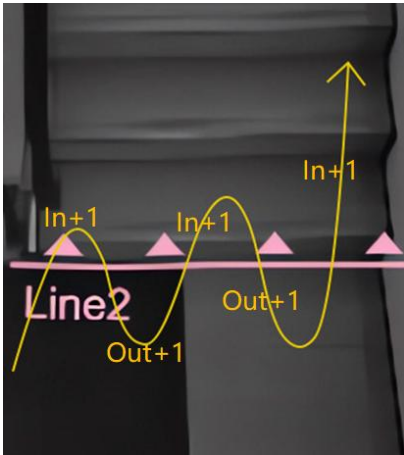

**Step 1:** Enable U-turn Filtering. Users can click  to edit U-turn areas for existed detection line on the live view.

The screenshot shows the Milesight web interface. On the left is a sidebar with navigation options: Dashboard, Rule, Communication, Report, Validation, System, English, and admin. The main view displays a live view of a detection area with lines and a region. Below the live view is a 'Multi-Device List' table:

Device	IP Address	SN	Device Name	Operation
Master	192.168.60....	6757D1617...	P3555555555...	
Node1			Bind Node1	
Node2			Bind Node2	

On the right, the configuration panel shows various detection settings. The 'U-turn Filtering' toggle is highlighted with a red box. Below it is a table for U-turn Filtering:

Line No.	Line Name	Operation
No.1	Line1	Edit Uturn Area
No.2	line 2	

Below the table is a '+ Add' button. Other settings include Enhanced Detection Mode, Children Distinction, Staff Detection, Shopping Cart Fill Level Detection, Heat Map, Line Cross Counting, Group Counting, and Region Monitoring.

**Step 2:** Left-click to start drawing and drag the mouse to draw an edge. Then left-click again to continue drawing a different direction edge. Right-click the mouse to complete the drawing. The area can be dragged to adjust the location and length. One device supports up to 4 broken lines with maximum 10 segments each.

**Step3:** If users want to redraw the line, click **Clear This Area** or drag the vertices of the area to adjust. Then click  to finish drawing.

**Step 4:** If users need to delete a certain U-turn area, click , then click **Clear This Area**.

Enhanced Detection Mode

Children Distinction

Staff Detection

Shopping Cart Fill Level Detection

Heat Map

Line Cross Counting

U-turn Filtering

Line No.	Line Name	Operation
No.1	Line1	<input type="checkbox"/> <input type="checkbox"/> <input type="checkbox"/> <input type="checkbox"/>
No.2	line 2	<input checked="" type="checkbox"/> <input type="checkbox"/> <input type="checkbox"/> <input type="checkbox"/>

+Add

Group Counting

Region Monitoring

Device	IP Address	SN	Device Name	Operation
Master	192.168.60...	6757D1617...	P3555555555...	<input type="checkbox"/>
Node1				<input type="checkbox"/> Bind Node1

## Draw Monitoring Region

VS135 supports monitoring the number and the dwell time of people in the region, providing more valuable analysis data.

**Step 1:** Enable Region Monitoring. Click **+Add** to add the region monitoring on the live view. Up to 4 regions are supported with maximum 10 segments each.

Line No.	Line Name	Operation
No.2	line 2	<input type="checkbox"/> <input type="checkbox"/> <input type="checkbox"/> <input type="checkbox"/>

+Add

Group Counting

Region Monitoring

Region No.	Region Name	Advanced Pro...	Operation
No.1	Region1	Region Peopl...	<input type="checkbox"/> <input type="checkbox"/> <input type="checkbox"/>

Please draw the area on the left frame.

+Add

Reset Cumulative Count on Schedule

Time of Reset Sat. 22:24:00

I/O Settings

Input Enable Line Crossing Count Externally

**Step 2:** Customize the zone name and enable Region People Counting or Dwell Time Detection as needed.

### Advanced Properties

Zone Name

Region People Counting

Pass-by Filtering   
s(0~3600)

Dwell Time Detection

Min. Dwell Time   
s(0~3600)

**Step 3:** The configuration is displayed in the list after the configuration is complete. You can redraw the areas by clicking the redraw button in the list. Click the edit button to modify the advanced settings of the areas or click delete button to delete the areas separately.

Region Monitoring

No.	Region Name	Advanced Properties	Operation
No.1	Region1	Region People Counting(5s)	<input type="button" value="✎"/> <input type="button" value="✖"/>
+ Add			

## Rule Configuration

Users can set the rules to ensure accurate counting.

Parameters	Description
Installation Height	Set the device installation height. Click <b>Detect</b> to detect the current installation height automatically. <b>Note:</b> 1) Ensure that there is no object directly below the device avoiding

	interfering the height detection. 2) The automatic detection of the installation height is not supported with dark floor/carpet (black, grey, etc.)
Max. Target Height	Set the maximum target height, then the device will ignore the objects higher than this setting value.
Min. Target Height	Set the minimum target height, then the device will ignore the object shorter than this setting value.
Tracking Mode	Select the tracking mode of counting, including Heads Tracking and Feet Tracking. <b>Note:</b> It is recommended to use heads tracking mode when the installation height is low in standalone working mode.
Enhanced Detection Mode	Turn on when any one of the following situations occurs, it will ensure normal counting and detecting: <ul style="list-style-type: none"> <li>• The depth image is abnormal;</li> <li>• There is obstacle in the live view;</li> <li>• Installation conditions are not met.</li> </ul>
U-turn Filtering	Enable or disable U-turn Filtering.
Children Distinction	The device will detect the people shorter than child filter height as children.
Staff Detection	The device will detect the people who wear reflective stripes as staff tags on the visible parts (neck, shoulders, etc.) as staffs. Reflective stripe requirements: width > 2cm, 500 cd/lux.m <sup>2</sup>
Group Counting	Click to enable the group counting function that based on the distance, moving direction and speed difference to gain deeper insights into customer' behaviors. <b>Note:</b> <ol style="list-style-type: none"> <li>1) This function is only applicable for line cross people counting.</li> <li>2) LoRa reporting only transmit group counting data when group counting function is enabled.</li> </ol>
<a href="#">Region Monitoring</a>	Enable or disable Region Monitoring.
Reset Cumulative Count on Schedule	Enable to periodically reset cumulative count on schedule. Cumulative Count includes: Total In/Out counting of each detection line. Max./Avg. Dwell Time of each detection region.
Periodic Report	Report the people counting data periodically.
Period	Set the period of reporting periodic report. Range: 1-1080 mins, default: 10 mins
Trigger Report	Report immediately when there is a change of the line crossing people counting number or region people counting number.

**Note:**

Due to the error in ToF distance measurement (0.035 m), the Max. Target Height should be set as maximum pedestrian height plus 0.035 m and the Min. Target Height as minimal pedestrian

height minus 0.035 m in the actual applications. For example, if the pedestrian height is 1.6 m to 1.8 m, the Max. and Min. Target Height should be configured as 1.835 m and 1.565 m respectively.

### 5.2.2 Multi-Device Stitching

Multi-device stitching is mainly used to monitor a larger detection area than just the area covered by a single device. When using this feature, devices should be installed next to each other and ensure the **detection areas** are tangent or overlapping.

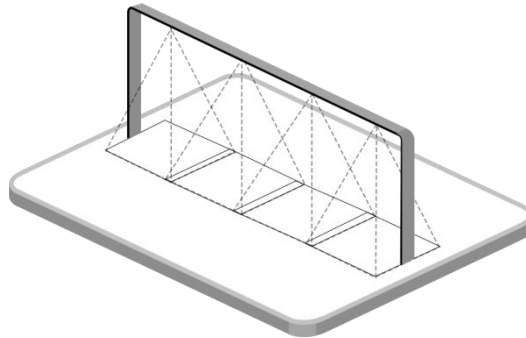

Before using this feature, set one device as **Master Mode** and other devices as **Node Mode**.

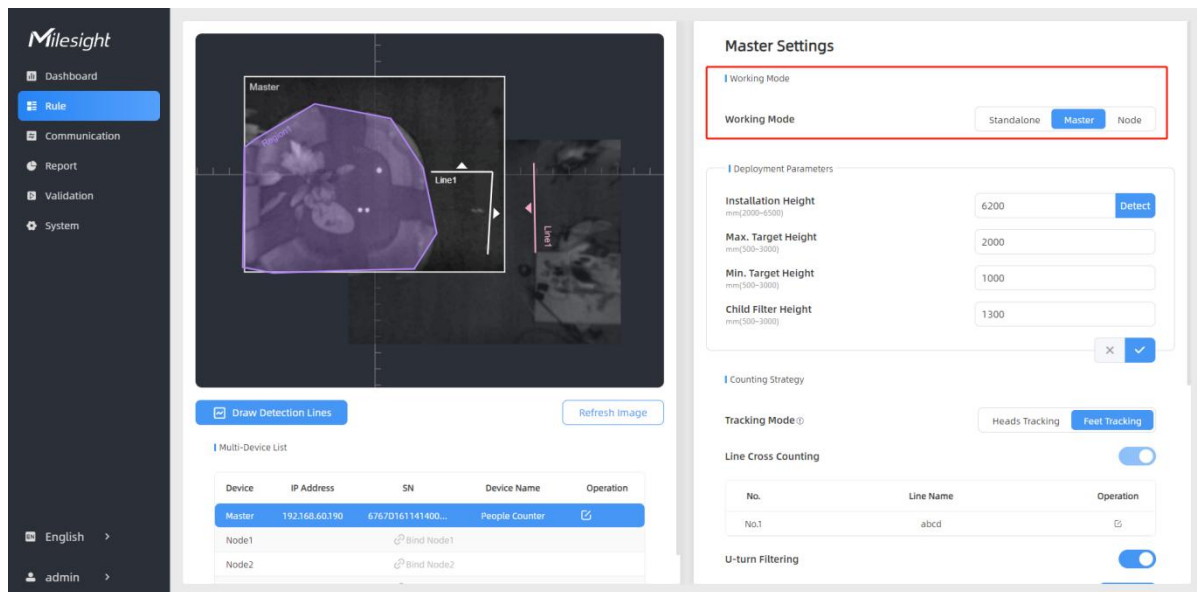

- **Master Mode:** Receive target tracks and view from the device, responsible for all counts, rule setting, data push and other functions. Report by wireless communication mode.
- **Node Mode:** Only extends the view of the master device.

Here is the device multi-stitching compatible list of VS13x series:

Stitching	Master Device	Node Devices	Stitching Number
Support	VS135-P	VS135-P	8
	VS135-P-High	VS135-P-High	
	VS135-L08EU	VS135-P, VS135-HL,	4

		VS135-LoRa, VS135-L08EU	
	VS135-L08EU-High	VS135-P-High, VS135-HL-High, VS135-LoRa-High, VS135-L08EU-High	
	VS135-HL	VS135-P, VS135-L08EU, VS135-LoRa, VS135-HL	
	VS135-HL-High	VS135-P-High, VS135-L08EU-High, VS135-LoRa-High, VS135-HL-High	
	VS135-LoRa	VS135-P, VS135-L08EU, VS135-HL, VS135-LoRa	
	VS135-LoRa-High	VS135-P-High, VS135-L08EU-High, VS135-HL-High, VS135-LoRa-High	
Not Support	VS135-P	VS135-LoRa, VS135-L08EU, VS135-HL	-
	VS135-P-High	VS135-LoRa-High, VS135-L08EU-High, VS135-HL-High	
	VS135 standard versions	VS135 high ceiling mount versions	
	VS135 high ceiling mount versions	VS135 standard versions	
	VS133-P	VS135-P	
	VS135-P	VS133-P	

**Note:**

- 1) Ensure the head of one person can be seen on both live views at the same time.

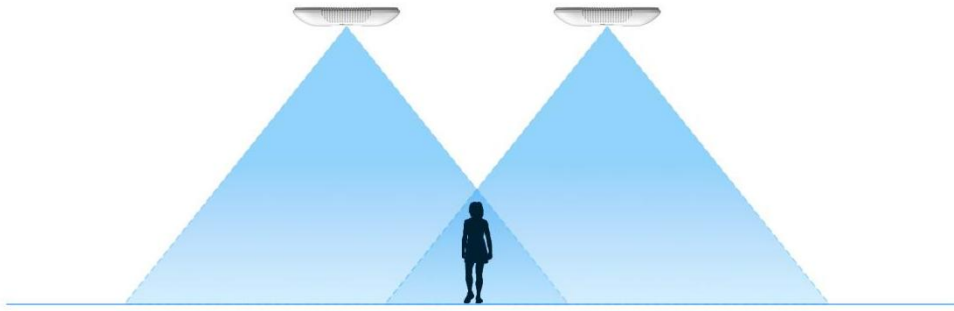

2) The devices can also be installed without overlapping as required.

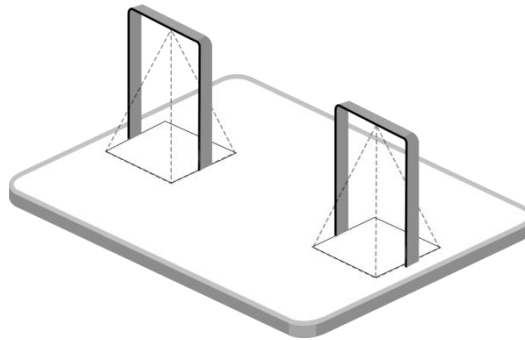

## Device Positioning

Device positioning is done via X&Y coordinates. For example, the installation direction of the master device is shown as below, the logo needs to be facing the front. When the master device's coordinate is (0, 0), the coordinates of the node devices are all positive values.

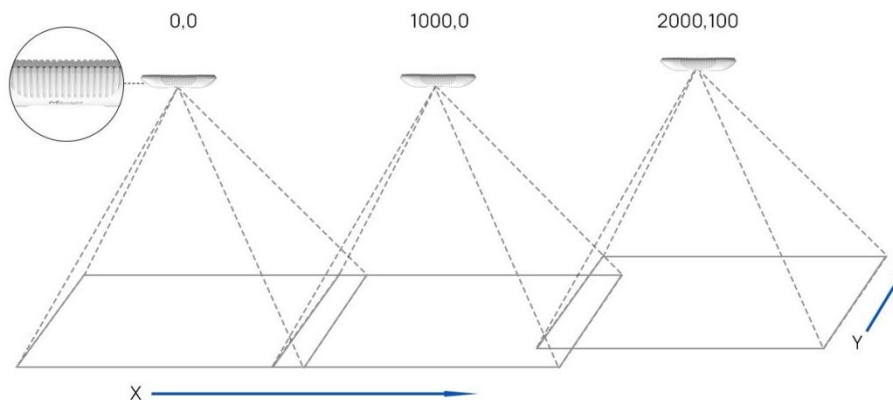

## Node Device Setting

**Step 1:** change the WLAN IP Address of node devices to different subnets from master device's WLAN IP address.

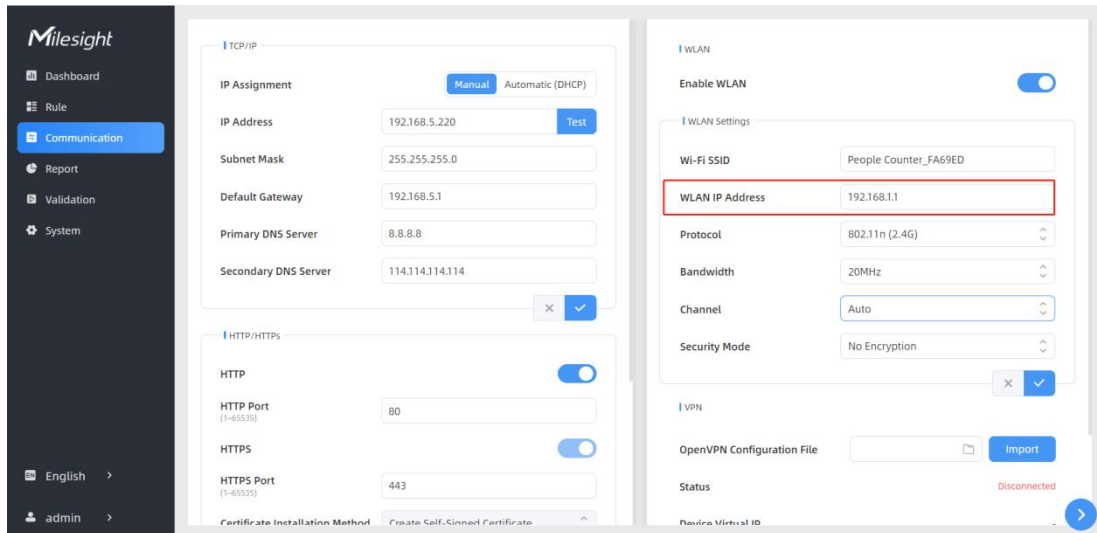

**Step 2:** Select work mode as Node and wait for the device to reboot.

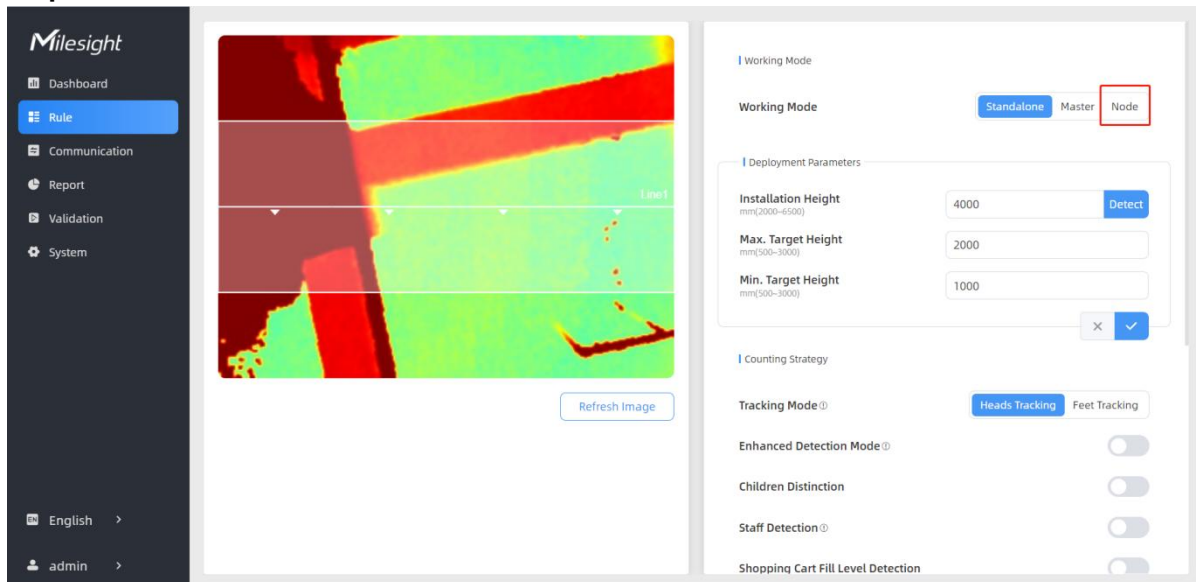

**Step 3:** Find the Wi-Fi access point of master device and connect.

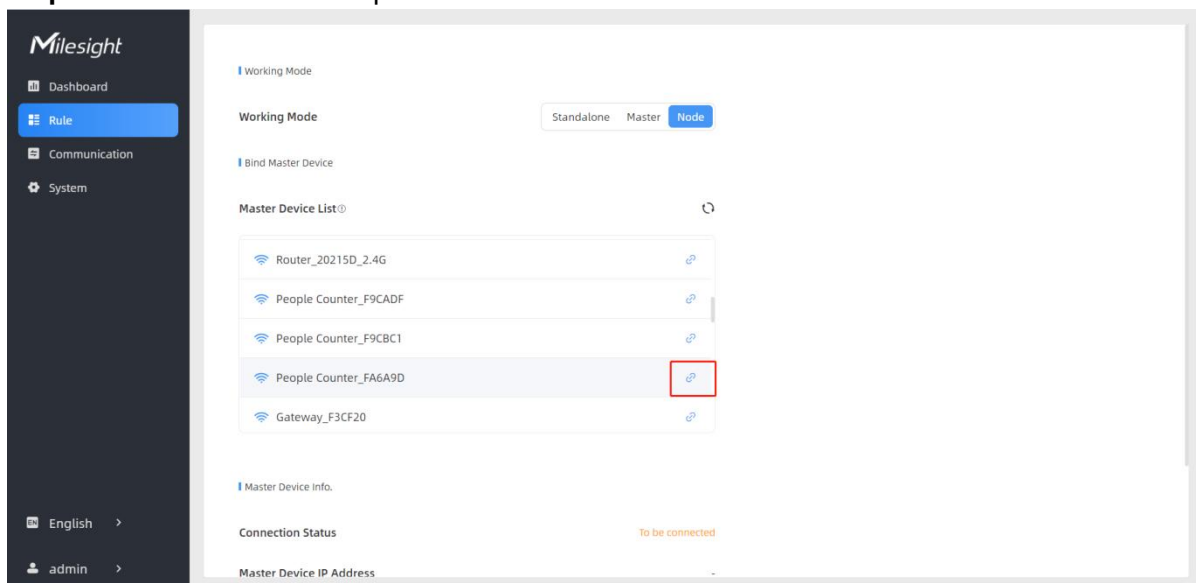

Parameters	Description
Connection Status	Show the connection status between the node device and master device.
Master Device IP Address	Show master device's IP address. When this IP address is under the same network with node device, the node device can bind to the master device.
Master Device SN	Show the master device's serial number.
Master Device Name	Show master device name.
Unbind Master Device	Click <b>Unbind</b> to release the connection status, this device will be deleted from the list of the master device.

## Master Device Setting

**Step 1:** When work mode is on Standalone or Node mode, select the WLAN channel to an idle channel. Users can use test App (like Wi-Fi Analyzer) to check ideal WLAN channels to reduce interference.

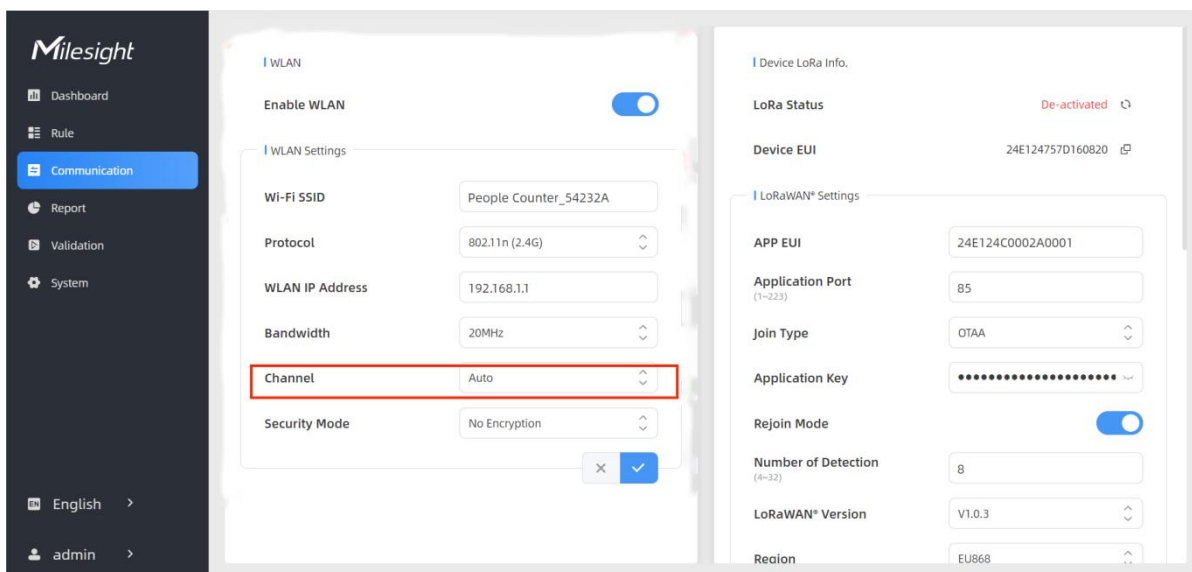

**Note:** the scene preview and people counting results are dependent on the WLAN channel selection, also the distance between node devices and master device. Please adjust the distance to ensure accurate scene preview or counting results.

WLAN Channel	Video Stream	Static Image/No Image	Counting Inaccuracy
Occupied Channel	Not Support	≤ 6.5m	> 6.5m
Idle Channel	≤8m	≤10m	>10m

**Step 2:** Select **Master** as the working mode and wait for the device to reboot.

**Step 3:** Go to the master device web GUI, then click **Bind Node** in the Multi-Device List. The device will use multicast protocol to search for the unbound node devices under the same local network.

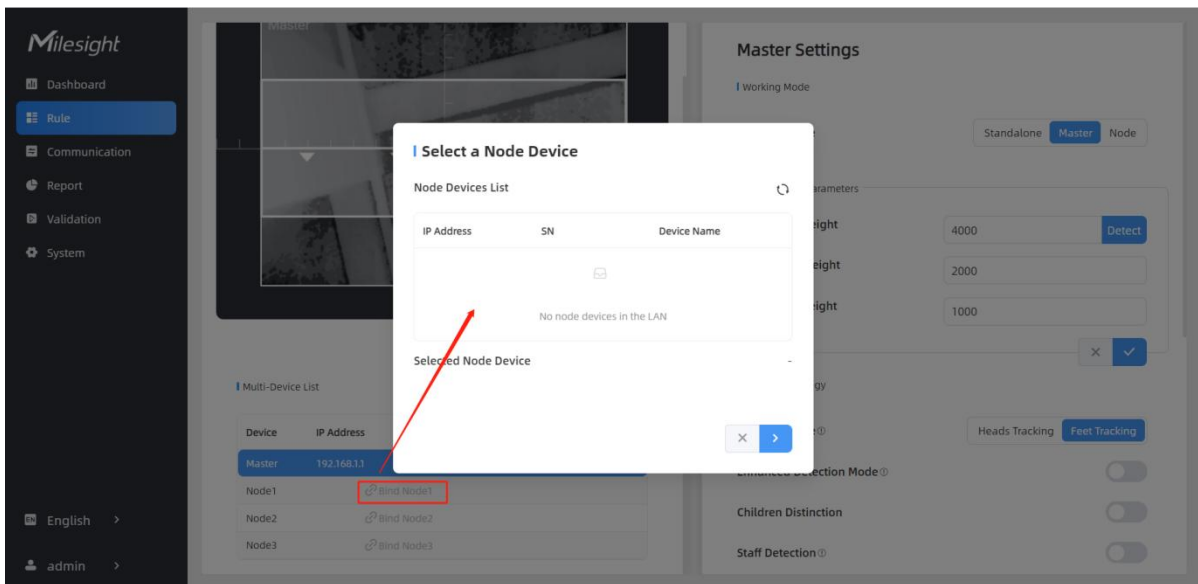

**Step 4:** Select the node device and type the login password of the node device.

**Step 5:** Fill in the installation height of a node device and relative position information if these parameters are already measured. If not, save default settings and skip to Step 6.

### Confirm Authorization

Selected Node Device: 192.168.46.80

Node Device Username:

Node Device Password:

### Bind the Node Device

Selected Node Device: 192.168.46.80

Installation Height:

Relative X Position:

Relative Y Position:

Relative Angle:

**Step 6:** Select the node device on the Multi-Device List, click **Adjust Relative Position**.

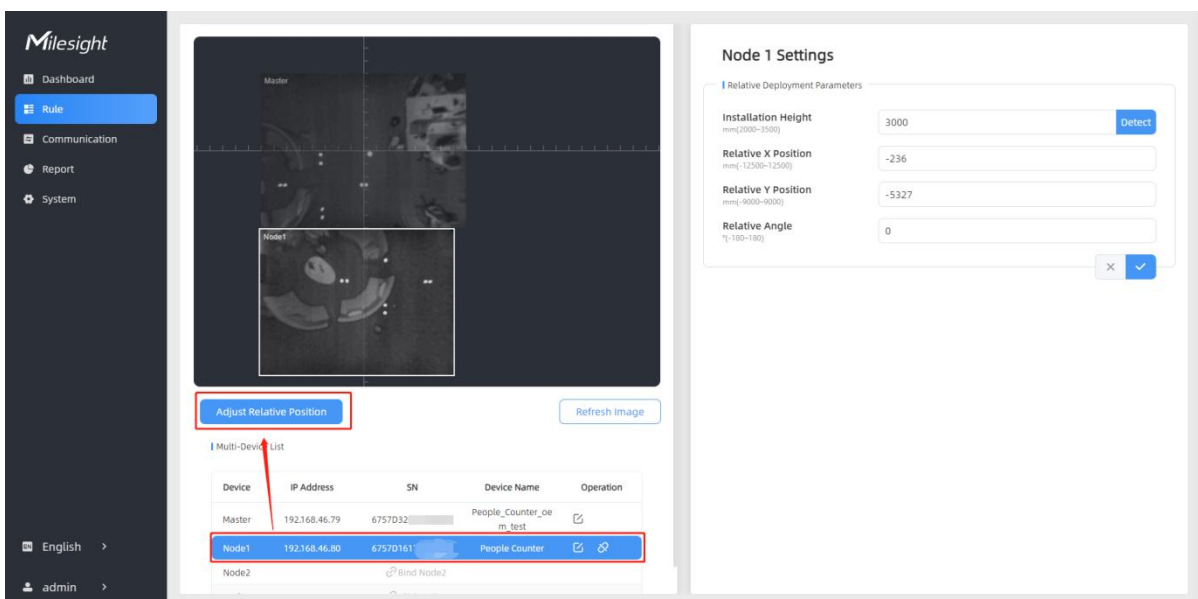

Drag the live view of node device to adjust the location and angle, and the relative position

parameters will change automatically as your operations. Besides, users can also adjust the size of this live view.

The screenshot shows the Milesight dashboard interface. On the left is a navigation menu with options: Dashboard, Rule (selected), Communication, Report, and System. The main area is split into two panels. The left panel shows a live view of a node device with a 'Set & Testing Track' button below it. The right panel is titled 'Node 1 Settings' and contains a 'Relative Deployment Parameters' section with the following fields:

- Installation Height: 2381 (range: mm(2000-3500)) with a 'Detect' button.
- Relative X Position: -2988 (range: mm(-12500-12500)).
- Relative Y Position: -1848 (range: mm(-9000-9000)).
- Relative Angle: 8 (range: °(-180-180)).

Below the settings is a 'Multi-Device List' table:

Device	IP Address	SN	Device Name	Operation
Master	192.168.46.79	6757D32675210018	People_Counter_oe m_test	[Icon]
Node1	192.168.46.80	6757D16179950018	People Counter	[Icon] [Icon]
Node2			Bind Node2	

**Tips:** cut the staff tags or other reflective stripes into pieces and stick them to the ground of overlapping areas, then drag the live view of node devices to make highlight markers in the two live views overlap. This allows equipment splicing configuration **without measurement**.

**Step 7:** Click **Set & Testing Track**, then check if the tracking lines are connected and smooth when people pass on the live views of multiple devices. If not, click **Stop Testing** to adjust the node device's live view location slightly.

The screenshot shows the Milesight dashboard interface. On the left is a navigation menu with options: Dashboard, Rule (selected), Communication, Report, and System. The main area is split into two panels. The left panel shows a live view of a node device with a 'Stop Testing' button below it. The right panel is titled 'Node 3 Settings' and contains a 'Relative Deployment Parameters' section with the following fields:

- Installation Height: 3000 (range: mm(2000-3500)) with a 'Detect' button.
- Relative X Position: 231 (range: mm(-12500-12500)).
- Relative Y Position: -2452 (range: mm(-9000-9000)).
- Relative Angle: 0 (range: °(-180-180)).

Below the settings is a 'Multi-Device List' table:

Device	IP Address	SN	Device Name	Operation
Master	192.168.46.79	6757D326	People_Counter_oe m_test	[Icon]
Node1	192.168.46.80	6757D161	People Counter	[Icon] [Icon]
Node2	192.168.46.83	6757D161	People Counter	[Icon] [Icon]
Node3	192.168.46.90	6757D16	People Counter	[Icon] [Icon]

**Step 8:** When all settings are completed, users can draw detection lines and even U-turn areas on the new stitching live view the same as standalone mode devices.

**Step 9:** Click **Unbind** to disconnect the node device if necessary.

The screenshot shows the Milesight web interface. On the left is a navigation menu with options: Dashboard, Rule, Communication, Report, and System. The main area is split into two panels. The left panel shows a map with nodes and a 'Multi-Device List' table. The right panel shows 'Node 3 Settings' with deployment parameters.

Device	IP Address	SN	Device Name	Operation
Master	192.168.46.79	6757D32	People_Counter_oe_m_test	[Icon]
Node1	192.168.46.80	6757D16	People Counter	[Icon]
Node2	192.168.46.83	6757D16	People Counter	[Icon]
Node3	192.168.46.90	6757D16	People Counter	[Icon]

The 'Node 3 Settings' panel includes the following parameters:

- Installation Height: 3000 mm (2000-3500)
- Relative X Position: 231 mm (-12500-12500)
- Relative Y Position: -2452 mm (-9000-9000)
- Relative Angle: 0 (°) (-180-180)

## 5.3 Communication

### 5.3.1 WLAN

VS135 supports wlan feature to work as AP mode to configure device and it can not connect to other access point.

The screenshot shows the Milesight web interface with the 'Communication' menu selected. The 'WLAN' settings are highlighted with a red box. The 'Device LoRa Info' section is also visible on the right.

**WLAN Settings:**

- Enable WLAN:
- Wi-Fi SSID: People Counter\_54232A
- Protocol: 802.11n (2.4G)
- WLAN IP Address: 192.168.3.3
- Bandwidth: 20MHz
- Channel: Auto
- Security Mode: No Encryption

**Device LoRa Info:**

- LoRa Status: De-activated
- Device EUI: 24E124757D160820
- LoRaWAN® Settings:
  - APP EUI: 24E124C0002A0001
  - Application Port: 85
  - Join Type: OTAA
  - Application Key: [Masked]
  - Rejoin Mode:
  - Number of Detection: 8
  - LoRaWAN® Version: V1.0.3
  - Region: EU868

Parameters	Description
Enable WLAN	Enable or disable Wi-Fi feature. If disabled, users can use button or LoRaWAN® downlink command to enable it.
Wi-Fi SSID	The unique name for this device Wi-Fi access point.
Protocol	802.11b (2.4 GHz), 802.11g (2.4 GHz), 802.11n (2.4 GHz) are optional.
WLAN IP	Configure WLAN IP address for web access, the default IP address is

Address	192.168.1.1.
Bandwidth	20 MHz or 40 MHz are optional.
Channel	Select the wireless channel. Auto, 1,...11 are optional.
Security Mode	No Encryption, WPA-PSK, WPA2-PSK and WPA-PSK/WPA2-PSK are optional.
Cipher	AES, TKIP, AES/TKIP are optional.
Wi-Fi Password	Customize the password when security mode is not No Encryption.

### 5.3.2 LoRa

LoRa settings are used for configuring the transmission parameters in LoRaWAN® network.

**Device LoRa Info.**

**LoRa Status** Activated 

**Device EUI** 24E124767D511657 

---

**LoRaWAN® Settings**

**APP EUI**

**Application Port**  
(1~223)

**Join Type**  

**Application Key**  

**Rejoin Mode**

**Number of Detection**  
(4~32)

**LoRaWAN® Version**  

**Region**  

**RX2 Data Rate**  

**RX2 Frequency**  
MHz(863~870)

**Spreading Factor**  

### Channel List

Enable	Frequency <small>MHz(863~870)</small>
<input checked="" type="checkbox"/>	868.1
<input checked="" type="checkbox"/>	868.3
<input checked="" type="checkbox"/>	868.5
<input type="checkbox"/>	<input type="text" value="867.1"/>
<input type="checkbox"/>	<input type="text" value="867.3"/>
<input type="checkbox"/>	<input type="text" value="867.5"/>
<input type="checkbox"/>	<input type="text" value="867.7"/>
<input type="checkbox"/>	<input type="text" value="867.9"/>

×
✓

LoRa Working Mode

Confirm Mode

ADR

Parameters	Description
LoRa Status	LoRaWAN® network joining status of this device.
Device EUI	Unique ID of the device, which can also be found on the label.
App EUI	The Default App EUI is 24E124C0002A0001.
Application Port	The port used for sending and receiving data, default port is 85.
Join Type	OTAA and ABP mode are available.
Application Key	Appkey for OTAA mode, the default key is 5572404C696E6B4C6F52613230313823.
Device Address	DevAddr for ABP mode, the default address is the 5 <sup>th</sup> to 12 <sup>th</sup> digits of SN.
Network Session Key	Nwkskey for ABP mode, the default key is 5572404C696E6B4C6F52613230313823.
Application Session Key	Appskey for ABP mode, the default key is 5572404C696E6B4C6F52613230313823.
Rejoin Mode	Reporting interval ≤ 35 mins: the device will send a specific number of LinkCheckReq MAC packets to the network server every reporting interval or every double reporting interval to validate connectivity; If there is no

	<p>response, the device will re-join the network.</p> <p>Reporting interval &gt; 35 mins: the device will send a specific number of LinkCheckReq MAC packets to the network server every reporting interval to validate connectivity; If there is no response, the device will re-join the network.</p>
Number of Detection	<p>When rejoin mode is enabled, set the number of detection.</p> <p><b>Note:</b> the actual sending number is <b>Number of Detection + 1</b>.</p>
LoRaWAN® Version	V1.0.2, V1.0.3 are available.
Region	Frequency plan of this device.
RX2 Data Rate	RX2 data rate to receive downlinks.
RX2 Frequency	RX2 frequency to receive downlinks.
Spreading Factor	If ADR is disabled, the device will send data via this spreading factor.
Channel	<p>Select the channel from channel list or enter the index to select the frequency channel.</p> <p><b>Index examples:</b></p> <p>1, 40: Enabling Channel 1 and Channel 40</p> <p>1-40: Enabling Channel 1 to Channel 40</p> <p>1-40, 60: Enabling Channel 1 to Channel 40 and Channel 60</p> <p>All: Enabling all channels</p> <p>Null: Indicates that all channels are disabled</p>
Confirm Mode	If the device does not receive ACK packet from network server, it will resend data once.
ADR	Allow network server to adjust data rate of the device.

**Note:**

- 1) Please contact sales for device EUI list if there are many units.
- 2) Please contact sales if you need random App keys before purchase.
- 3) Only OTAA mode supports rejoin mode.
- 4) Select OTAA mode when you connect device to Milesight IoT Cloud.

## 5.4 Report

VS135 supports visual line chart or bar chart generation to display people traffic and supports report exporting. Before using this feature, do ensure that the device time is correct on **System** page.

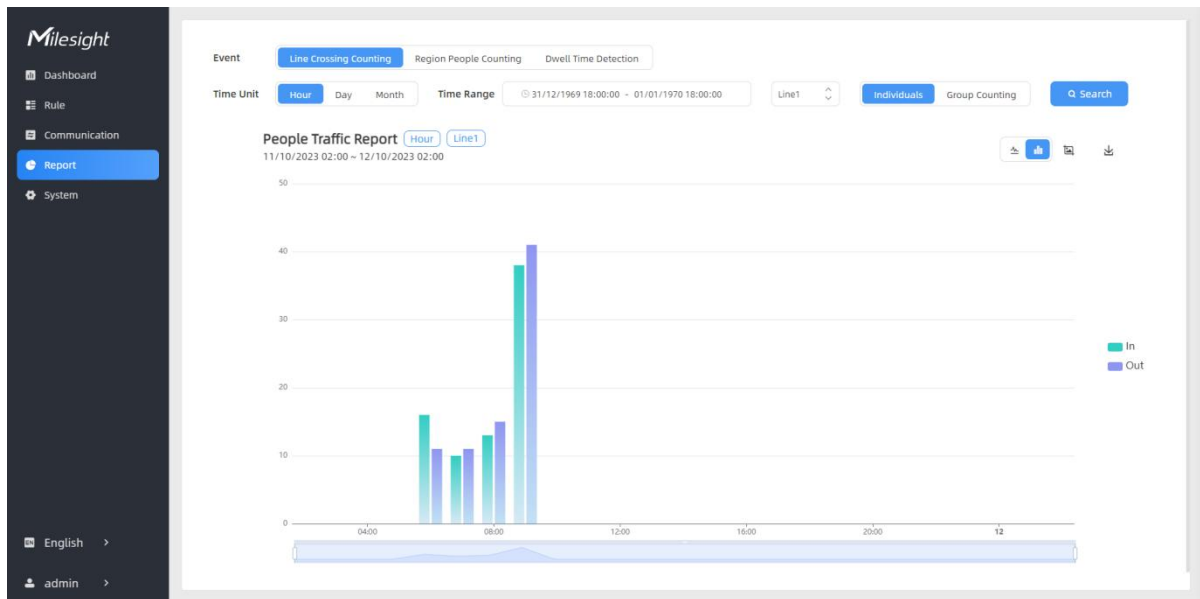

Parameters	Description
Event	Select the event which you want to query the report. Line crossing counting, region people counting and dwell time detection are optional.
Time Unit	Select the unit to generate the graph or export the data.
Time Range	Select the time range to generate the graph.
Line1	Select the line to display the graph.
Individuals Groups	Select the individuals counting reports or groups counting reports.
Region1	Select the region to display the graph.
Search	Click to generate the graph according to the time range and line option.
Export	Export the historical traffic data as CSV file according to the selected time unit. The device can store up to one million data records to CSV file.
Staff Included/Excluded	Select whether to contain staff counting values on the graph.
Line/Bar	Select the display type as line or bar.
Download	Download the graph screenshot.

## 5.5 Validation

Video validation function can assist users in verifying the accuracy of people counting by setting up a video task of recording.

Parameters	Description
Task Name	Show the task name.
Start/End Time	Show the start time and end time of this video.
Duration	Show the length of the video.
Task Status	Show the video task status.
Operation	Click to check the video details, stop recording or delete the task.
+Add	Click to add a video task. One device can add up to 24 tasks.

### Set a Task of Recording

Task Name

Recording Mode Record Now Setting Time

Start Time

Duration   
min(1~240)

Video Quality Standard Low Quality

✕ ✓

Parameters	Description
Task Name	Customize a name for this task.
Recording Mode	Record Now or Setting Time is optional.
Start Time	Set the start recording time.
Duration	Set the duration of the recording, the duration of all tasks should not be

	more than 240 minutes.
Video Quality	When video quality is low, the video size will be smaller and quicker to download.

**Note:**

- The setting time range of different tasks can not be overlap.
- Detection rules and ToF frequency parameters cannot be modified during the recording process.
- If the validation videos need to be played locally, please contact Milesight IoT support for a specialized player.

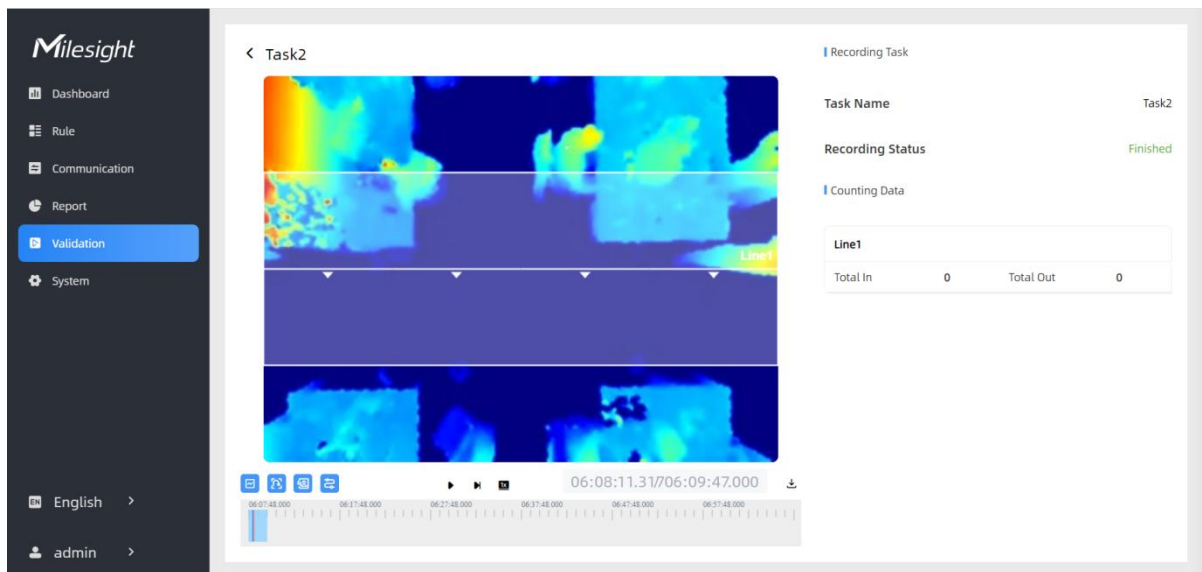

	Parameters	Description
Playback Button		Enable/Disable detection lines in the recording footage.
		Enable/Disable u-turn area in the recording footage.
		Enable/Disable detection region in the recording footage.
		Enable/Disable tracking line in the recording footage.
		Rewind/Pause/Play/Forward(supports switching between 0.5x, 1x, 2x, and 4x playback speed).
		Start time and end time of the recording.
		Download video stream footage.

**Note:** The playback progress bar of video stream footage highlights the video frame where the data changes.

## 5.6 System

### 5.6.1 Device Info

All information about the hardware and software can be checked on this page.

The screenshot displays the Milesight System configuration interface. On the left is a dark sidebar with navigation options: Dashboard, Rule, Communication, Report, Validation, and System (highlighted in blue). Below the sidebar are language and user selection options: English and admin.

The main content area is divided into two panels:

- Device Info:** A form with fields for Device Name (People Counter), Product Model (VS135-868M), SN (6767D51165730004), Hardware Version (V1.2), Software Version (V\_135.1.0.5-r1-b), and WLAN MAC Address (24:E1:24:36:37:38). A red box highlights this section.
- Users:** A table with columns Username, User Level, and Operation. It lists an 'admin' user with 'Administrator' level and edit/delete icons. Below the table is an '+ Add User' button.
- System Time:** A section for configuring system time, including Date (01/02/2024), Time (12:43:52), Time Zone (UTC-0:00 Western European Time (WET), Greenwich Mean Ti), Daylight Saving Time (toggle off), and Setting Time (01/02/2024 12:43:50). A 'Synchronize' button is present.

### 5.6.2 User

This screenshot is identical to the previous one, but with a red box highlighting the 'Users' table in the 'Device Info' section.

Parameters	Description
	You can change the login password of this device.

### Users modify

Username	<input type="text" value="admin"/>
User Level	<input type="text" value="Administrator"/>
Administrator Password	<input type="password"/>
New Password	<input type="password"/>
Confirm	<input type="password"/>

At least:

- 8 characters
- 2 types of characters: Number, letter and symbol



Click to set three security questions for your device. In case that you forget the password, you can click **Forget Password** button on login page to reset the password by answering three security questions correctly.

### Secure Question Settings Already Set

Password	<input type="password"/>
Security Question1	<input type="text" value="What is your lucky number?"/>
Answer1	<input type="text"/>
Security Question2	<input type="text" value="What is your favorite sport?"/>
Answer2	<input type="text"/>
Security Question3	<input type="text" value="What is your favorite game?"/>
Answer3	<input type="text"/>



Click to add a viewer, who will only have access to the "Dashboard" and "Report" interfaces.

### Add User

Username	<input type="text" value="viewer"/>
User Level	<input type="text" value="Viewer"/>
Password	<input type="password"/>
Confirm	<input type="password"/>

At least:

- 8 characters
- 2 types of characters: Number, letter and symbol



+ Add User

## 5.6.3 Time Configuration

Parameters	Description
Time Zone	Choose the time zone for your location.
Daylight Saving Time	Enable or disable Daylight Saving Time (DST). <b>Start Time:</b> the start time of DST time range. <b>End Time:</b> the end time of DST time range. <b>DST Bias:</b> the DST time will be faster according to this bias setting.
Setting Time	Set the device time manually.
Synchronize with computer time	Synchronize the time with your computer.

## 5.6.4 System Maintenance

Parameters	Description
Frequency Adjustment	Adjust the ToF frequency modulation mode to avoid the interference of surrounding IR devices. Please avoid using the same mode if there are multiple VS135 devices around. <b>Note:</b> If there is only one option, please contact Milesight IoT support: <a href="mailto:iot.support@milesight.com">iot.support@milesight.com</a>
ToF Lighting Mode	Adjust the ToF light mode as Always On, Auto or Schedule. When using Auto mode, the device will turn off the ToF light when radar detects no person for some times to save the power. <b>Note:</b>

- 1) ToF light off will not affect the periodic report.
- 2) During validation, the ToF lighting will be fixed as On irregardless of its lighting mode configuration.
- 3) When using ToF Lighting Mode, the Dashboard will display relevant information.

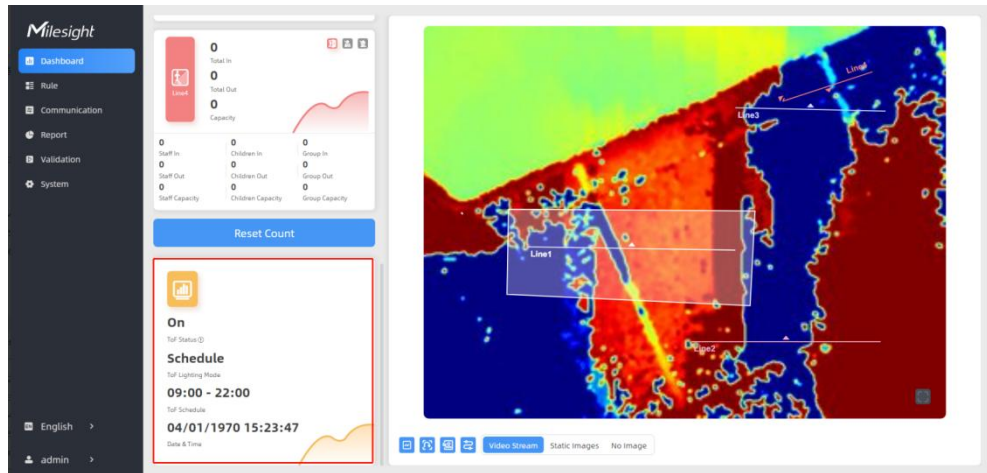

ToF Noise Filtering	Filter the noisy point on the screen when working with dark floor or carpet.
Noise Filtering Level	<p><b>Standard Version:</b> When installing in a spacious environment with black carpet, it is recommended to set the strength to 2; when installing in a narrow environment with black carpet, it is recommended to set the strength to 10.</p> <p><b>High Ceiling Mount Version:</b> When installing in a spacious environment with black carpet: it is recommended to set the strength to 18; when installing in a narrow environment with black carpet, it is recommended to set the strength to 9.</p>
Tilt Correction	Enable to automatic compensation of person height values when the device is mounted at a tilt.
Reset	<p><b>Recovery device basic configuration:</b> keep the IP settings and user information when resetting.</p> <p><b>Recovery device to factory settings:</b> reset device to factory default, which needs to verify admin password.</p>
Reboot	Restart the device immediately.
Upgrade	<p>Click the folder icon and select the upgrading file, then click the <b>Upgrade</b> button to upgrade. The update will be done when the system reboots successfully.</p> <p><b>Note:</b> The upgrade process takes about 1-10 minutes. Do not turn off the power and complete automatic restart after the upgrade.</p>
Backup and Restore	<p><b>Export Config File:</b> Export configuration file.</p> <p><b>Import Config File:</b> Click the file icon and select the configuration file, click <b>Import</b> button to import configuration file.</p>

## 6. Installation Instruction

Parameter definition:

Parameters	Explanation	Value
H	Installation height	Standard Version: $\leq 3.5$ m High Ceiling Mount: $\leq 6.5$ m
d	Minimum detection distance of VS135	Standard Version: 0.5 m High Ceiling Mount: 2 m
$\Delta d$	Distance measurement error of VS135	0.035 m
$h_{\max}$	Maximum pedestrian height	Example 1.8 m
$h_{\min}$	Minimum pedestrian height	Example 1.7 m
$\alpha$	ToF horizontal field of view angle	Standard Version: $98^\circ$ High Ceiling Mount: $60^\circ$
$\beta$	ToF vertical field of view angle	Standard Version: $80^\circ$ High Ceiling Mount: $45^\circ$
x	Length of detection range	
y	Width of detection range	

### 6.1 Installation Height

- The maximum installation height is 3.5 m and the minimum installation height is  $h_{\max}+d+\Delta d$ . For example, when the maximum pedestrian height is 1.8 m, then the minimum installation height is  $1.8+0.5+0.035=2.335$  m.
- The maximum installation height is 6.5 m and the minimum installation height is  $h_{\max}+d+\Delta d$ . For example, when the maximum pedestrian height is 1.8 m, then the minimum installation height is  $1.8+2+0.035=3.835$  m.

### 6.2 Covered Detection Area

The detection area covered by the device is related to the field of view angle of the device, the installation height and the target height. The length of the detection area is approximately  $x=1.155 \times (H-h_{\min})$  and the width of the detection area is approximately  $y=0.828x$  ( $H-h_{\min}$ ).

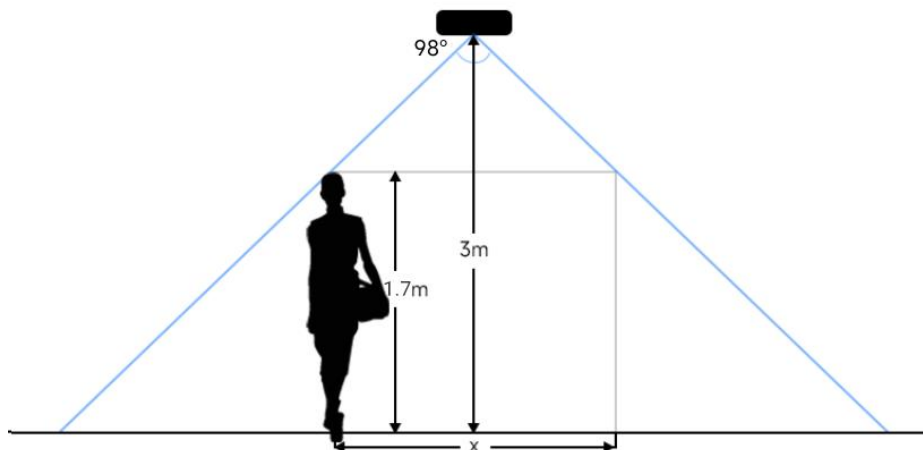

For example, if the Minimum height of pedestrians is 1.7 m, the detection area corresponding to each installation height is as follows:

**Standard Version:**

Installation Height (m)	Monitored Area (m)	Detection Area(m)
2.5	5.75 × 4.20	1.84 × 1.34
2.6	5.98 × 4.36	2.07 × 1.51
2.7	6.21 × 4.53	2.30 × 1.68
2.8	6.44 × 4.70	2.53 × 1.85
2.9	6.67 × 4.87	2.76 × 2.01
3.0	6.90 × 5.03	2.99 × 2.18
3.1	7.13 × 5.20	3.22 × 2.35
3.2	7.36 × 5.37	3.45 × 2.52
3.3	7.59 × 5.54	3.68 × 2.69
3.4	7.82 × 5.71	3.91 × 2.85
3.5	8.05 × 5.87	4.14 × 3.02

**High Ceiling Mount Version:**

Installation Height (m)	Monitored Area (m)	Detection Area(m)
3.5	4.04 x 2.90	2.08 x 1.49
3.7	4.27 x 3.07	2.31 x 1.66
3.9	4.50 x 3.23	2.54 x 1.82
4.1	4.73 x 3.40	2.77 x 1.99
4.3	4.97 x 3.56	3.00 x 2.15
4.5	5.20 x 3.73	3.23 x 2.32
4.7	5.43 x 3.89	3.46 x 2.49
4.9	5.66 x 4.06	3.70x 2.65
5.1	5.89 x 4.22	3.93 x 2.82
5.3	6.12 x 4.39	4.16 x 2.98
5.5	6.35 x 4.56	4.39 x 3.15
5.7	6.35 x 4.72	4.62 x 3.31
5.9	6.81 x 4.89	4.85 x 3.48
6.1	7.04 x 5.05	5.08 x 3.65
6.3	7.27 x 5.22	5.31 x 3.81
6.5	7.51 x 5.38	5.54 x 3.98

## 6.3 Environment Requirements

- Dark floor/carpet (black, grey, etc.) will affect the device to count staffs when Staff Detection is enabled.

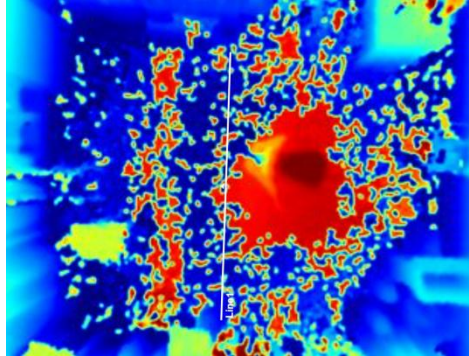

- Avoid 940nm light which may result in incorrect counting.
- Outdoor sunlight shining on the over channel will not have any effect, but the mirrored reflections that allow sunlight to shine on the ToF Sensor should be avoided.
- **Make sure there are no obstacles within the live view of device. Otherwise, the device imaging may appear abnormally red or it will affect people counting. When the carpet/floor is black, make sure to adjust Noise Filtering Level to max value.**

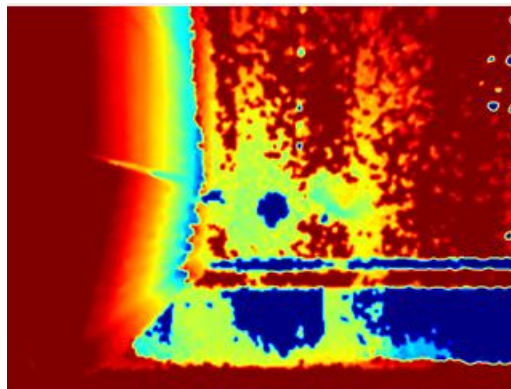

## 6.4 Installation

### Ceiling Mount

Installation condition: ceiling thickness > 30mm.

**Step 1:** Take down the side covers.

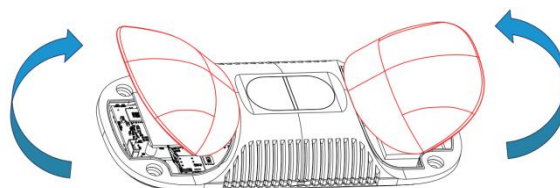

**Step 2:** Fix wall plugs into ceiling holes.

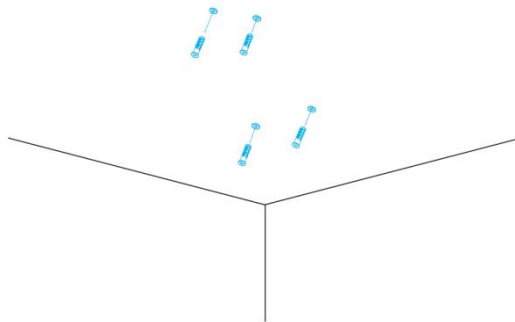

**Step 3:** Remove rubber plugs on the rubber sleeve, connect all required wires.

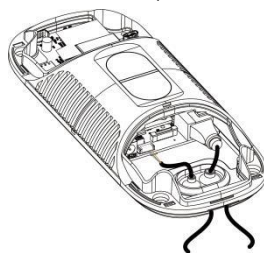

**Note:**

- Remove the rubber sleeve if waterproof is not required for easy installation.
- Use round wires.
- Ensure the rubber sleeve and the bottom cover are tightly connected without a gap if waterproof is required; if necessary, wrap the waterproof tapes around the wires to avoid any gap.
- Tighten the wires to avoid contact with internal modules.

**Step 4:** Fix the device to ceiling with mounting screws.

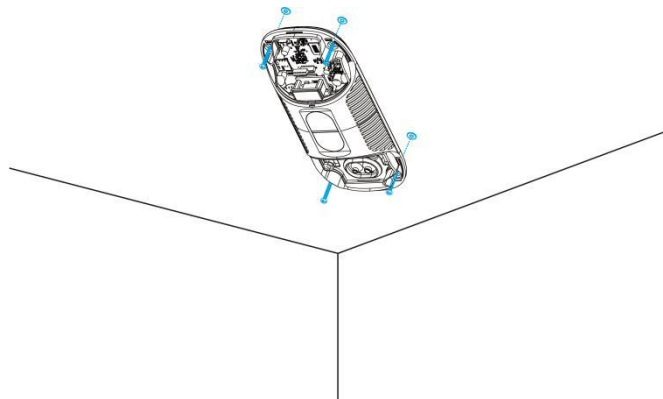

**Step 5:** Restore side covers.

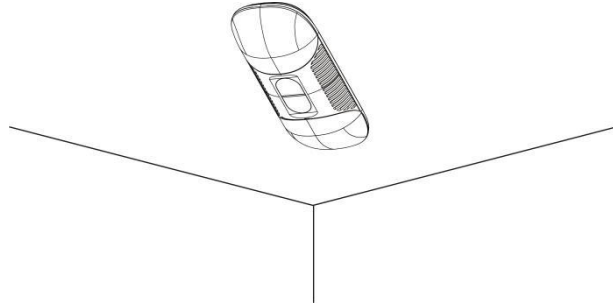

### Ceiling/Lintel Mount (with Optional VB01 Multifunctional Bracket)

Step 1: Fix the pole to the device with the hole on the device.

Step 2: Adjust the length of the pole, then adjust the direction of 3-axis ball and tighten it with the handle.

Step 3: Determine the mounting location and drill 3 holes, fix the wall plugs into the mounting holes, then fix the bracket base to the wall plugs via mounting screws.

(Note: If the wire needs to be extended to the interior of the ceiling or wall, a wire hole with a suitable size is also required to be drilled.)

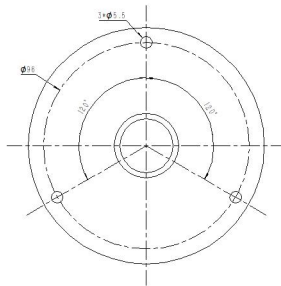

Step 4: Remove the cover on the device, and then connect all required wires and pass them through the inside of pole.

Step 5: Fix the pole to bracket base with screws and nuts.

#### Ceiling Mount

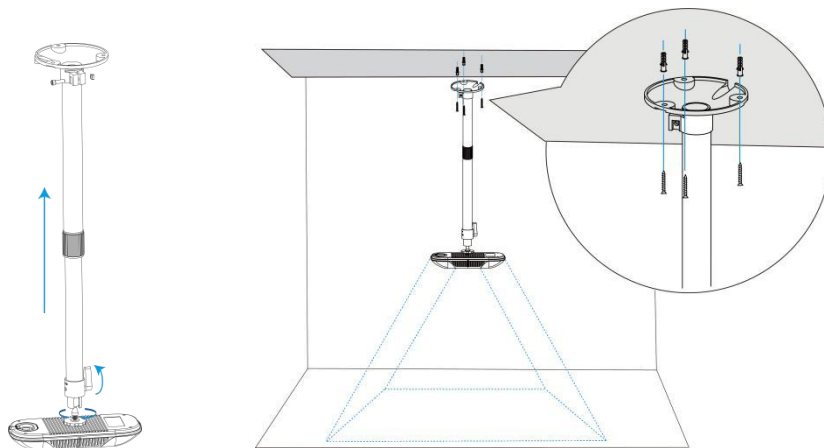

#### Lintel Mount

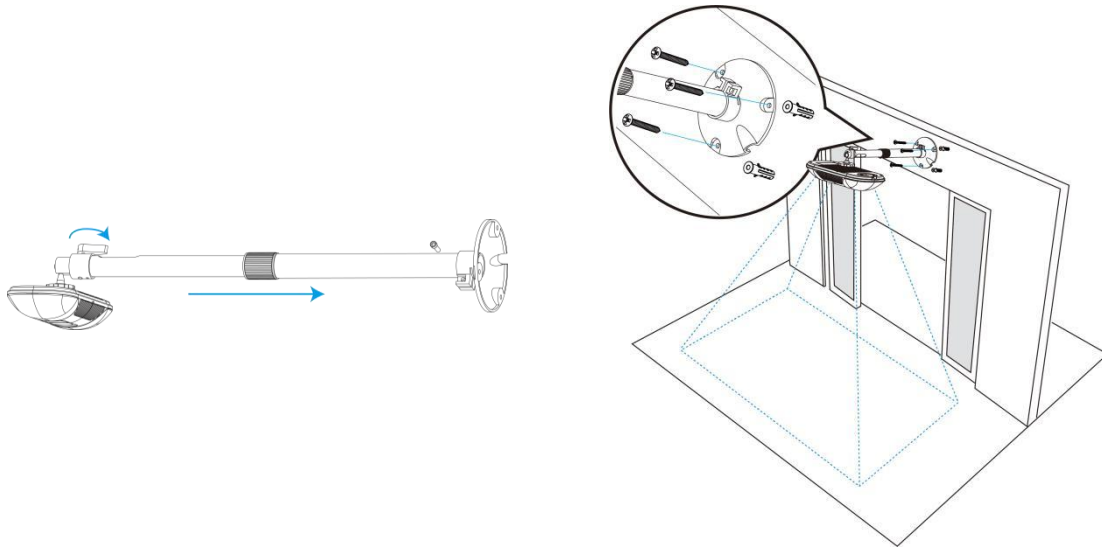

### Installation Note:

- Ensure that the ToF sensor is facing down and the tilt angle from the ground is no greater than 15° for the standard version, and no greater than 10° for the high ceiling mount version.
- Avoid direct Infrared LED light in the detection area.
- Not suggested to install the sensor close to glass or mirror.
- Ensure that there are no other objects blocking the ToF light within a 50cm radius of the device's field of view.
- Avoid installing the device against the wall and ensure the distance between the device and the wall as follows:

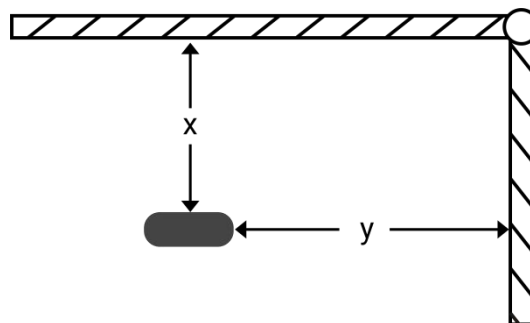

Condition	Standard Environment	The carpet/floor is Dark (need to set max noise filtering level)
Normal imaging	$x > 50\text{cm}$ , $y > 60\text{cm}$	$x > 50\text{cm}$ , $y > 75\text{cm}$
Normal counting	$x > 50\text{cm}$ , $y > 50\text{cm}$	$x > 50\text{cm}$ , $y > 50\text{cm}$

- When you install devices on the top of swinging doors, it is suggested to keep the door normally open. If the door must be normally closed, please install the device on the other side of the door to keep away from the door's movement. And it is suggested to keep away

from the door with a distance of at least 40cm.

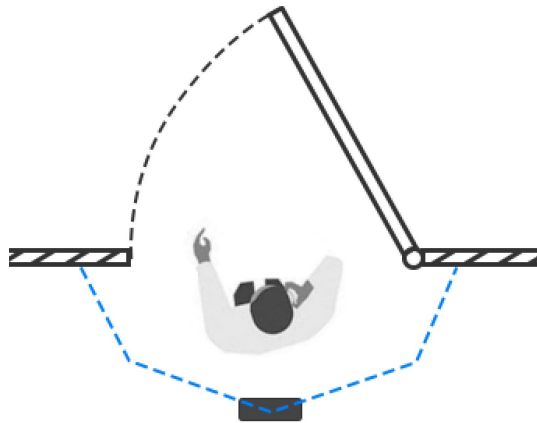

## 6.5 Factors Affecting Accuracy

- Wearing a fisherman's hat or carrying a cardboard box on the shoulder: The target will not be recognized because it will become unlike a human in depth map.
- Handheld or cart-carrying a humanoid doll with sufficient height to pass by: The doll will be mistakenly detected as people because it is human-like in depth map.

## 7. Communication Protocol

### 7.1 Uplink Data

VS135 reports basic information of sensor once joining the network and the number of people periodically. For decoder examples please find files on

<https://github.com/Milesight-IoT/SensorDecoders>.

Channel	Type	Description
ff	01 (Protocol Version)	01=> V1
	09 (Hardware Version)	01 04 => V1.4
	16 (Device SN)	16 digits
	1f (Software Version)	85 01 00 05 => 133.1.0.5
03	d2 (Accumulated counter)	Line 1 accumulated in counter, 4 bytes
04	d2 (Accumulated counter)	Line 1 accumulated out counter, 4 bytes
05	cc (Periodic counter)	<b>Line 1:</b> <b>Byte 1-2:</b> in counter during the report interval <b>Byte 3-4:</b> out counter during the report interval
06	d2 (Accumulated counter)	Line 2 accumulated in counter, 4 bytes

07	d2 (Accumulated counter)	Line 2 accumulated out counter, 4 bytes
08	cc (Periodic counter)	<b>Line 2:</b> <b>Byte 1-2:</b> in counter during the report interval <b>Byte 3-4:</b> out counter during the report interval
09	d2 (Accumulated counter)	Line 3 accumulated in counter, 4 bytes
0a	d2 (Accumulated counter)	Line 3 accumulated out counter, 4 bytes
0b	cc (Periodic Counter)	<b>Line 3:</b> <b>Byte 1-2:</b> in counter during the report interval <b>Byte 3-4:</b> out counter during the report interval
0c	d2 (Accumulated counter)	Line 4 accumulated in counter, 4 bytes
0d	d2 (Accumulated counter)	Line 4 accumulated out counter, 4 bytes
0e	cc (Periodic Counter)	<b>Line 4:</b> <b>Byte 1-2:</b> in counter during the report interval <b>Byte 3-4:</b> out counter during the report interval
0f	e3 (Region Monitoring)	<b>Byte 1:</b> number of people in region 1 <b>Byte 2:</b> number of people in region 2 <b>Byte 3:</b> number of people in region 3 <b>Byte 4:</b> number of people in region 4
10	e4 (Region Monitoring)	<b>Byte 1:</b> region ID <b>Byte 2-3:</b> avg. dwell time <b>Byte 4-5:</b> max. dwell time

**Note:** If children distinction feature or staff detection feature is enabled, the counter uplinks will minus children and staff. For example, if children distinction is enabled, the accumulated in counter=total in counter-children in, the accumulated out counter=total out counter-children out.

**Example:**

1. Device information

ff0101 ff166600b09409760000 ff090102 ff1f85010001					
Channel	Type	Value	Channel	Type	Value
ff	01 (Protocol Version)	01 (V1)	ff	16(Device SN)	66 00 b0 94 09 76 00 00
Channel	Type	Value	Channel	Type	Value
ff	09 (Hardware version)	0102 (V1.2)	ff	1f (Software version)	85 01 00 01 (V133.1.0.1)

2. Line 1 People counter

03d205000000 04d203000000 05cc02000100					
Channel	Type	Value	Channel	Type	Value
03	d2 (accumulated in counter)	05 00 00 00 => 00 00 00 05=5	04	d2 (accumulated out counter)	03 00 00 00 => 00 00 00 03=3
Channel	Type	Value			
05	cc (Periodic Counter)	In: 02 00 => 00 02 = 2 Out: 01 00 => 00 01 =1			

## 7.2 Downlink Command

VS135 supports to configure the device via downlink commands. Application port is 85 by default.

Channel	Type	Description
ff	10 (Reboot)	ff (Reserved)
	03 (Reporting Interval)	2 Bytes, unit: s
	04 (Confirm Mode)	00: disable, 01: enable
	05 (LoRaWAN® Channel Mask)	<b>Byte 1:</b> Channel index range 01: 0-15 02: 16-31 03: 32-47 04: 48-63 05: 64-79 06: 80-95 <b>Byte 2-3:</b> indicate disable or enable via every bit, 0=disable, 1=enable
	40 (ADR)	00: disable, 01: enable
	41 (Application Port)	1 Byte, default is 85
	42 (Wi-Fi)	00: disable, 01: enable
	43 (People Counting Periodic Report)	00: disable, 01: enable
	44 (People Counting Trigger Report)	00: disable, 01: enable
	51 (Clear the accumulated counting)	ff (Reserved)

**Note:** After changing any parameter of LoRaWAN® settings, the device will re-join the network.

**Example:**

## 1. Disable Wi-Fi.

ff4200		
Channel	Type	Value
ff	42 (Wi-Fi)	00: disable

## 2. Set AU915 or US915 channel mask as 8-15.

ff0501ff00 ff05020000 ff05030000 ff05040000 ff05050000		
Channel	Type	Value
ff	05 (Set Channel Mask)	01: Channel index 0-15, ff00 => 8-15 is enabled 02-05: Channel index 16-79, 0000 => all disabled

## 3. Reboot the device.

ff10ff		
Channel	Type	Value
ff	10 (Reboot)	ff (Reserved)

## 4. Set reporting interval as 20 minutes.

ff03b004		
Channel	Type	Value
ff	03(Set Reporting Interval)	b0 04 => 04 b0 = 1200s =20 minutes

-END-