

Passage People Counter

Featuring LoRaWAN®

VS350

User Guide



Safety Precautions

Milesight will not shoulder responsibility for any loss or damage resulting from not following the instructions of this operating guide.

- ❖ The device must not be disassembled or remodeled in any way.
- ❖ The device is not intended to be used as a reference sensor, and Milesight will not hold responsibility for any damage which may result from inaccurate readings.
- ❖ Do not paint or clean the PIR lens, or it will affect the detection of the device.
- ❖ Do not place the device in places where the temperature is below/above the operating range.
- ❖ Do not place the device near naked flames, heat source (such as oven), or expose it to sunlight, cold source, liquid, and with extreme temperature changes.
- ❖ Remove the battery from the device if it is not to be used for an extended period. Otherwise, the battery might leak and damage the device.
- ❖ The device must never be subjected to shocks or impacts.

Declaration of Conformity

VS350 is in conformity with the essential requirements and other relevant provisions of the CE, FCC, and RoHS.

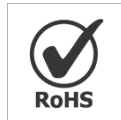

Copyright © 2011-2024 Milesight. All rights reserved.

All information in this guide is protected by copyright law. Whereby, no organization or individual shall copy or reproduce the whole or part of this user guide by any means without written authorization from Xiamen Milesight IoT Co., Ltd.

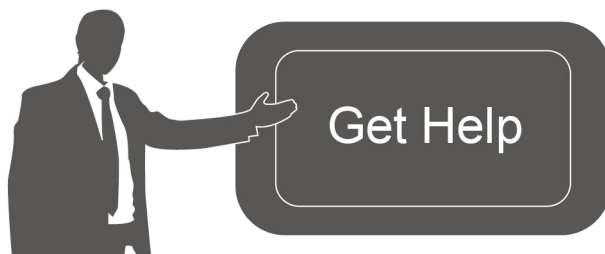

For assistance, please contact

Milesight technical support:

Email: iot.support@milesight.com

Support Portal: support.milesight-iot.com

Tel: 86-592-5085280

Fax: 86-592-5023065

Address: Building C09, Software Park
Phase III, Xiamen 361024,
China

Revision History

Date	Doc Version	Description
Aug. 31, 2023	V 1.0	Initial version
Apr. 7, 2024	V 1.1	Update installation detection range based on new hardware

Contents

1. Product Introduction	5
1.1 Overview	5
1.2 Key Features	5
2. Hardware Introduction	6
2.1 Packing List	6
2.2 Hardware Overview	6
2.3 Reset Button and LED Indicator	6
2.4 Dimensions (mm)	7
3. Power Supply	7
4. Operation Guide	7
4.1 NFC Configuration	7
4.2 LoRaWAN® Settings	8
4.3 General Settings	10
4.4 Advanced Settings	11
4.4.1 Calibration Settings	11
4.4.2 Threshold Settings	11
4.4.3 Data Storage	12
4.4.4 Data Retransmission	13
4.4.5 Milesight D2D Settings	14
4.5 Maintenance	16
4.5.1 Backup	16
4.5.2 Upgrade	17
4.5.3 Reset to Factory Default	17
5. Installation Instruction	18
5.1 Installation	18
5.2 Factors Affecting Accuracy	20
6. Device Payload	20
6.1 Basic Information	20
6.2 Sensor Data	21
6.3 Downlink Commands	22
6.4 Historical Data Enquiry	24

1. Product Introduction

1.1 Overview

VS350 is an exceptional indoor passage people counter that detects and analyzes the flow of people, allowing for optimum space management and usage. Equipped with dual PIR sensors, it offers a high accuracy rate for bi-directional people counting. When combined with the additional temperature sensor, the VS350 can achieve more potential triggers, increasing its detection capabilities. As a Milesight D2D controller, the VS350 seamlessly communicates with other Milesight D2D devices, establishing more possible connections and paving the way for smoother operations.

With easy configuration and wireless detection, the VS350 facilitates simple deployment and connectivity. Compliant with the Milesight LoRaWAN® gateway and Milesight IoT Cloud solution, users can access the number of passage people and trigger other sensors or appliances easily via a webpage or mobile App remotely.

1.2 Key Features

- Provide good accuracy rate for bi-directional people counting with dual PIR sensors
- Ultra-low power consumption with up to 4-year battery life without replacement
- 100% anonymity and GDPR-compliant without image capturing, free from privacy concerns
- Equipped with a reliable and cost-effective sensor system for counting people through passages
- Function well with people counting with perfect-fit detecting ranges
- Wireless connectivity and convenient size that improve the accessibility and simplicity of deployment
- Built-in temperature sensor, enabling environmental detection
- Able to store 1000 historical records locally and support retransmission to prevent data loss
- Equipped with NFC for one-touch configuration and support card emulation mode
- Function well with standard LoRaWAN® gateways and network servers
- Compatible with Milesight IoT Cloud
- Support Milesight D2D protocol to enable ultra-low latency and direct control without a gateway

2. Hardware Introduction

2.1 Packing List

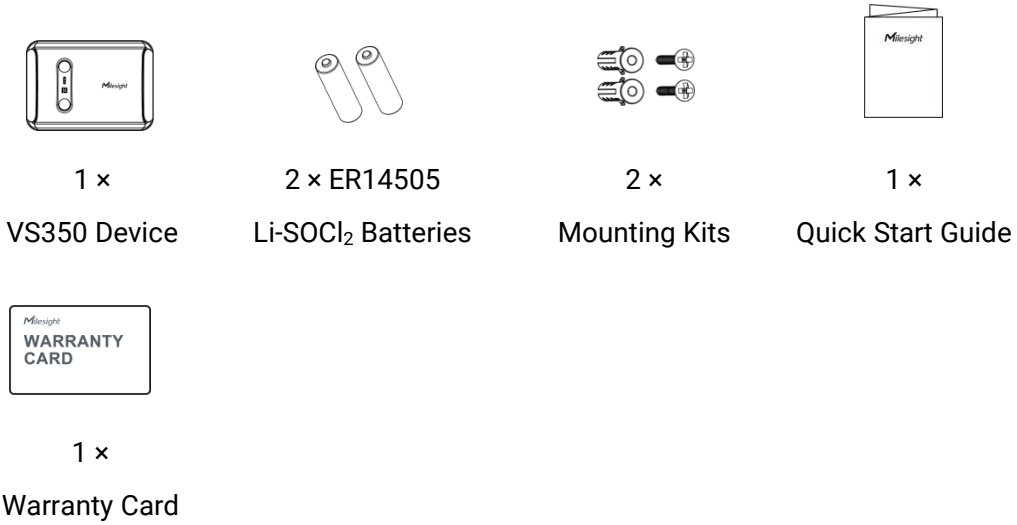

! If any of the above items are missing or damaged, please contact your sales representative.

2.2 Hardware Overview

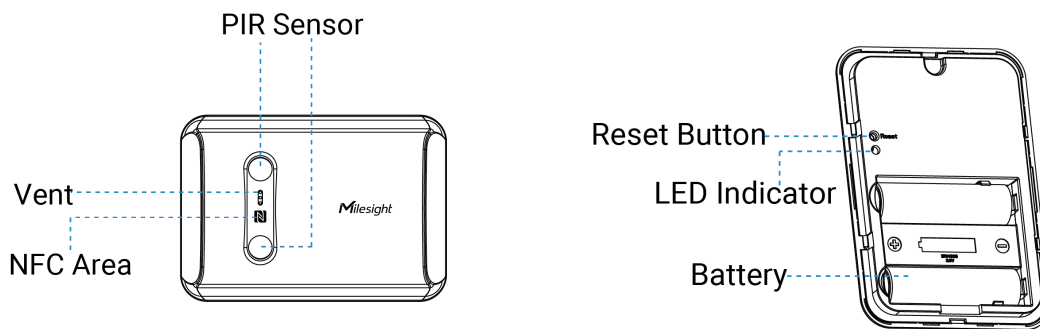

2.3 Reset Button and LED Indicator

Function	Action	LED Indicator
Reset to Factory Default	Press and hold the reset button for more than 10 seconds	Blink quickly

2.4 Dimensions (mm)

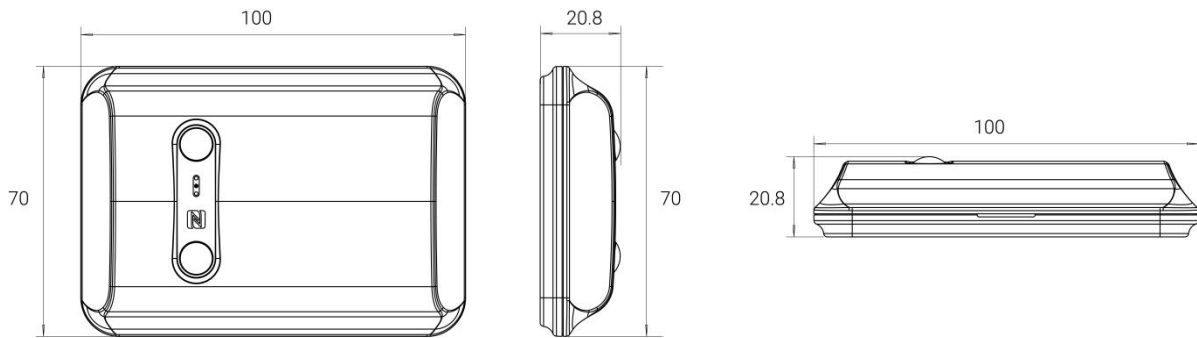

3. Power Supply

Remove the battery cover at the back of device to insert two batteries in the right direction. After inserting the batteries, the device will turn on automatically.

Note:

- 1) The device can only be powered by ER14505 Li-SOCl₂ batteries, not alkaline batteries.
- 2) Make sure both batteries are newest when install, or battery life will be reduced.

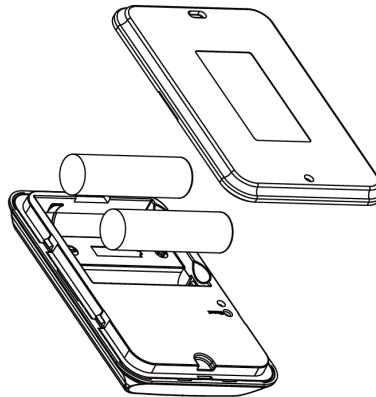

4. Operation Guide

4.1 NFC Configuration

VS350 can be monitored and configured via NFC. Please refer to the following configuration steps.

1. Download and install the Milesight ToolBox App from Google Play or Apple App Store.
2. Enable NFC on your smartphone and launch Milesight ToolBox.
3. Attach the smartphone's NFC area to the device, and click **NFC Read** to read device information. The basic information and settings of the device will be shown on ToolBox App if it's recognized successfully. You can read and configure the device by tapping the Read/Write

device on the App. For better security, please change the password during the first configuration. The default password is **123456**.



Note:

- 1) Ensure the location of NFC area of the smartphone and it is recommended to remove your phone case.
- 2) If the smartphone fails to read/write configurations via NFC, remove the phone and try again.

4.2 LoRaWAN® Settings

Configure AppEUI, Join Type, Application Key, and other information. You can also keep all settings by default.

Device EUI

24E124791D196040

* APP EUI

24e124c0002a0001

* Application Port 85

Join Type

ABP

* Network Session Key

* Application Session Key

Parameters	Description
Device EUI	Unique ID of the device which can also be found on the label.
App EUI	The default App EUI is 24E124C0002A0001.
Application Port	The port is used for sending and receiving data, the default port is 85.
Join Type	OTAA and ABP modes are available.

Application Key	Appkey for OTAA mode, the default is 5572404C696E6B4C6F52613230313823.												
Network Session Key	Nwkskey for ABP mode, the default is 5572404C696E6B4C6F52613230313823.												
Application Session Key	Appskey for ABP mode, the default is 5572404C696E6B4C6F52613230313823.												
Device Address	DevAddr for ABP mode, the default is the 5th to 12th digits of the SN.												
LoRaWAN® Version	V1.0.2 and V1.0.3 are available.												
Work Mode	It's fixed as Class A.												
RX2 Data Rate	RX2 data rate to receive downlinks.												
RX2 Frequency	RX2 frequency to receive downlinks. Unit: Hz												
Channel Mode	Select Standard-Channel mode or Single-Channel mode. When Single-Channel mode is enabled, only one channel can be selected to send uplinks. Please enable Single-Channel mode if connecting to the DS7610.												
Supported Frequency	<p>Enable or disable the frequency to send uplinks.</p> <p>Examples:</p> <p>1, 40: Enabling Channel 1 and Channel 40</p> <p>1-40: Enabling Channel 1 to Channel 40</p> <p>1-40, 60: Enabling Channel 1 to Channel 40 and Channel 60</p> <p>All: Enabling all channels</p> <p>Null: Indicate that all channels are disabled</p> <p>Channel Mode</p> <p>Standard-Channel</p> <p>Enable Channel Index ⓘ</p> <p>0-71</p> <table border="1"> <thead> <tr> <th>Index</th> <th>Frequency/MHz ⓘ</th> </tr> </thead> <tbody> <tr> <td>0 - 15</td> <td>902.3 - 905.3</td> </tr> <tr> <td>16 - 31</td> <td>905.5 - 908.5</td> </tr> <tr> <td>32 - 47</td> <td>908.7 - 911.7</td> </tr> <tr> <td>48 - 63</td> <td>911.9 - 914.9</td> </tr> <tr> <td>64 - 71</td> <td>903 - 914.2</td> </tr> </tbody> </table>	Index	Frequency/MHz ⓘ	0 - 15	902.3 - 905.3	16 - 31	905.5 - 908.5	32 - 47	908.7 - 911.7	48 - 63	911.9 - 914.9	64 - 71	903 - 914.2
Index	Frequency/MHz ⓘ												
0 - 15	902.3 - 905.3												
16 - 31	905.5 - 908.5												
32 - 47	908.7 - 911.7												
48 - 63	911.9 - 914.9												
64 - 71	903 - 914.2												

Confirmed Mode	If the device does not receive an ACK packet from the network server, it will resend data once.
Rejoin Mode	Reporting interval \leq 35 mins: the device will send a specific number of LinkCheckReq MAC packets to the network server every reporting interval or every double reporting interval to validate connectivity; If there is no response, the device will re-join the network. Reporting interval $>$ 35 mins: the device will send a specific number of LinkCheckReq MAC packets to the network server every reporting interval to validate connectivity; If there is no response, the device will re-join the network.
Set the number of packets sent	When the rejoin mode is enabled, set the number of LinkCheckReq packets to send. Note: the actual sending number is Set the number of packet sent + 1 .
ADR Mode	Allow network server to adjust the data rate of the device.
Spread Factor	If ADR is disabled, the device will send data via this spread factor.
Tx Power	Transmit power of the device.

Note:

- 1) Please contact sales personnel for device EUI list if there are many units.
- 2) Please contact sales personnel if you need random App keys before purchase.
- 3) Select OTAA mode if you are using Milesight IoT cloud to manage devices.
- 4) Only OTAA mode supports rejoin mode.

4.3 General Settings

Reporting Interval min

Reset Accumulated Value

Reset Interval min

Data Storage ⓘ

Data Retransmission ⓘ

Report Accumulated Value

Report Temperature

Temperature Unit

Change Password

Parameters	Description
Reporting Interval	The interval of reporting people counting data and battery level to network server. Default: 10 min, Range: 1 - 1440 min
Reset Accumulated Value	Enable or disable to reset accumulated in/out counting values. Note: the device will reset automatically when accumulate counting values reaches 65535 even this option is disabled.
Reset Interval	The interval to reset accumulated in/out counting values. Default: 1440 min, Range: 1 - 65535 min
<u>Data Storage</u>	Disable or enable data storage locally.
<u>Data Retransmission</u>	Disable or enable data retransmission.
Report Accumulated Value	Disable or enable to report accumulated counting values in periodic packets.
Report Temperature	Disable or enable to report temperature in periodic packets, this option will not affect temperature threshold alarm packets.
Temperature Unit	Set the temperature unit displayed on the status page.
Change Password	Change the password for ToolBox App to write this device.

4.4 Advanced Settings

4.4.1 Calibration Settings

VS350 supports numerical calibration of the temperature value. Go to **Device > Settings > Calibration Settings** of ToolBox App to set the calibration value, the device will add calibration value to the current value and report the final value.



4.4.2 Threshold Settings

Go to **Device > Settings > Threshold Settings** of ToolBox App to enable and configure the threshold settings. If the threshold is triggered, the device will report the threshold alarm packet instantly.

Note: The optimal operating temperature range from 15°C to 32°C. The device will also report

alarm packet when temperature is above 32°C, even if the temperature threshold is disabled.

People Counting

In >

Out >

Accumulated In >

Accumulated Out >

Temperature

Over / °C

Below / °C

4.4.3 Data Storage

VS350 supports storing 1000 data records locally and exports data via ToolBox App. The device will record the data according to the reporting interval even if it is disconnected from the network. **Note that VS350 only stores people counting data.**

1. Go to **Device > Status** of ToolBox App to sync the device time.

Device Time 2023-08-08 19:22

2. Go to **Device > Setting > General Settings** to enable the data storage feature.

Data Storage

Data Retransmission

3. Go to **Device > Maintenance** of ToolBox App, click **Export**, then select the data time range and click **Confirm** to export data. The maximum export data period on ToolBox App is 14 days.

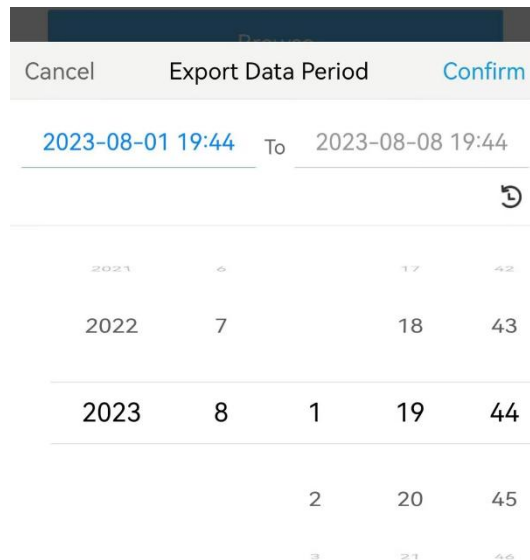

4. Click **Export Record** to find the export file records.



Note: Swipe the file record to the left to delete .

5. Click **Data Cleaning** to clear all stored data inside the device if necessary.

Export Historical Data



4.4.4 Data Retransmission

VS350 supports data retransmission to ensure the network server can receive all data even if the network is down for some time. There are two ways to receive the lost data:

- Network server sends downlink commands to enquire the historical data for a specified time range, refer to section [Historical Data Enquiry](#);
- When network is down and receive no response from LinkCheckReq MAC packets for a period of time, the device will record the time of disconnection and retransmit the lost data after the device is reconnected to the network.

Here are the steps of data retransmission:

1. Go to **Device > Setting > General Settings** to enable data storage feature and data

retransmission feature.



2. Go to **Device > Setting > LoRaWAN Settings** to enable rejoin mode feature and set the number of packets sent. Take below as an example, the device will send LinkCheckReq MAC packets to the network server regularly to check for any network disconnection; if there is no response for 8+1 times, the join status will change to de-active and the device will record a data lost time point (the time it reconnected to the network).

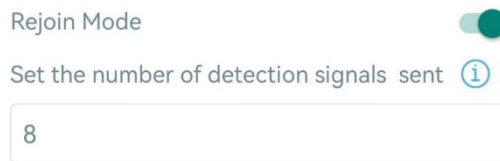

3. After reconnecting to the network, the device will send the lost data from the point of time when the data was lost according to the data re-transmission reporting interval.

Note:

- 1) If the device is rebooted or re-powered during the data retransmission process, the device will re-send interrupted retransmission data again after the device is reconnected back to the network.
- 2) If the network is disconnected again during data retransmission, the device will only send the latest disconnected data.
- 3) The retransmission data format starts with "20ce", please refer to section [Historical Data Enquiry](#).
- 4) Data retransmission will increase the uplinks and shorten the battery life.

4.4.5 Milesight D2D Settings

Milesight D2D protocol is developed by Milesight and used for setting up transmission among Milesight devices without a gateway. When the Milesight D2D setting is enabled, VS350 can work as a Milesight D2D controller to send control commands to trigger Milesight D2D agent devices.

1. Configure RX2 data rate and RX2 frequency in LoRaWAN[®] settings, it is suggested to change the default value if there are many LoRaWAN[®] devices around.
2. Go to **Device > Settings > D2D Settings** to enable D2D function and configure the D2D settings.

Enable

D2D Key

Someone Entered

Control command

LoRa Uplink ⓘ

Control Time /min ⓘ

Someone Left

People Counting Threshold Triggered

Temperature Threshold Triggered

Temperature Threshold Released

Parameters	Description
Enable	Enable or disable Milesight D2D feature.
D2D Key	Define a unique D2D key which is the same as the setting in D2D agent devices. Default value: 5572404C696E6B4C6F52613230313823
Status Condition	<p>When VS350 detects one or more of the below statuses, it will send the control command to the corresponding Milesight D2D agent devices:</p> <ul style="list-style-type: none"> ● Someone entered ● Someone Left ● People Counting Threshold Triggered ● Temperature threshold Triggered ● Temperature threshold Released <p>Note: for people counting and temperature threshold conditions, please enable and configure the threshold feature under Threshold Settings.</p>
Control command	Define a 2-byte hexadecimal control command (0x0000 to 0xffff).
LoRa Uplink	If enabled, a LoRaWAN® uplink packet that contains the counting value or temperature alarm will be sent to gateway after the Milesight D2D control command is sent.

Control Time /min ¹	After receiving commands from VS350, Milesight D2D agent devices will take corresponding actions within this duration. Default: 5 mins, Range: 1 - 1440 mins
-----------------------------------	---

4.5 Maintenance

4.5.1 Backup

VS350 supports backup templates for easy and quick device configurations in bulk. The backup feature is only for devices with the same model and LoRaWAN® frequency band.

1. Go to **Template** page on the App and save the current settings as a template. The saved templates are also editable.





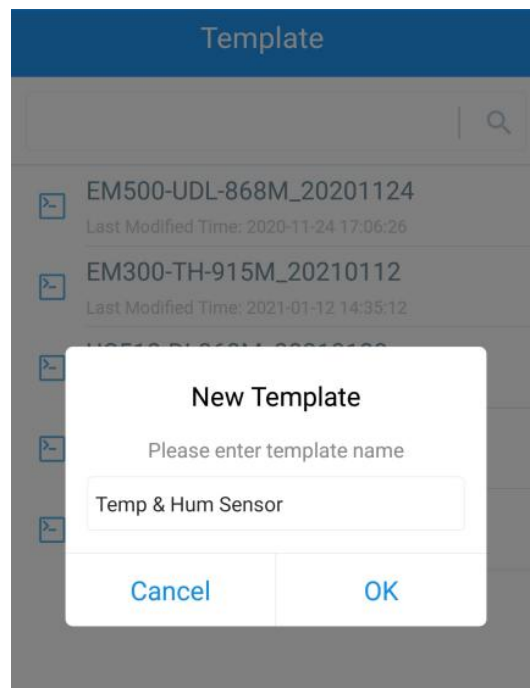

2. Select one saved template and click **Write**, then attach the smartphone to another device via NFC to reuse the template.



Note: Swipe the template item to the left to edit or delete the template. Click the template to edit the configurations.

¹ This feature is under development on Milesight D2D agent devices.

Template	
 EM500-UDL-868M_20201124 Last Modified Time: 2020-11-24 17:06:26	
 EM300-TH-915M_20210112 Last Modified Time: 2021-01-12 14:35:12	
 UC512-DI-868M_20210128 Last Modified Time: 2021-01-28 16:57:20	
 UC501-470M_20210201 Last Modified Time: 2021-02-01 11:29:43	
v_20210208 Last Modified Time: 2021-02-08 16:44:37	<div style="display: flex; gap: 10px;"> Edit Delete </div>

4.5.2 Upgrade

1. Download firmware from the Milesight website to your smartphone.
2. Go to **Device > Maintenance** of ToolBox App, tap **Browse** to import firmware and upgrade the device.

Note:

- 1) Operation on ToolBox is not supported during the upgrade.
- 2) Only the Android version of ToolBox supports the upgrade feature.

Status	Setting	Maintenance
SN	6716D30624210005	
Model	VS350-868M	
Firmware Version	V1.1	
Hardware Version	V1.0	
Manual Upgrade		
<div style="background-color: #007bff; color: white; padding: 10px; display: inline-block; border-radius: 5px;">Browse</div>		

4.5.3 Reset to Factory Default

VS350 supports two methods to reset the device, which are as following:

Via Hardware: Press and hold the reset button for more than 10s until the LED indicator blinks quickly.

Via ToolBox App: Go to **Device > Maintenance** to tap **Reset**, then attach the smartphone to the

device via NFC to complete the reset.

Status	Setting	Maintenance
SN	6716D30624210005	
Model	VS350-868M	
Firmware Version	V1.1	
Hardware Version	V1.0	
Manual Upgrade		
Browse		
Restore Factory Default		
Reset		

5. Installation Instruction

5.1 Installation

Ceiling Mount:

1. Take off the back cover of the device, and drill 2 holes in the ceiling according to the mounting holes on the cover.
2. Fix the wall plugs into the ceiling, then fix the back cover to wall plugs with screws. Note the pedestrian direction arrow on the cover when fixing.
3. Install the device back to the cover.

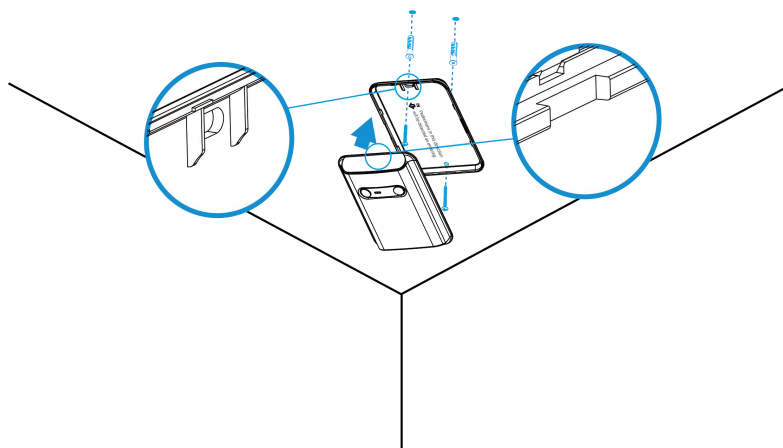

Installation Note:

1. Make sure the sensor is facing straight down and parallel to the ceiling.

2. Avoid installing the device against the wall and ensure the device is away from the wall at least 45 cm.
3. Do not install the device close to the entrance or exit. If necessary, ensure there is no other door near the entrance/exit or door is normally opening.
4. The optimal operating temperature range is between 15°C and 32°C, so keep the device away from heat sources, cold sources, and the areas where airflow varies greatly like the areas with windows, vents, fans, and air conditioners.
5. The maximum detection ranges at different heights when environment temperature is 20°C:

Installation Height (m)	Passage Detection Width (m)
2.2	2
2.3	2.2
2.7	2.5
3.0	2.8

The higher the environment temperature, the smaller the detection range.

Wall Mount:

1. Take off the back cover of the device, then fix the wall plugs to the wall according to the device mounting holes on the cover.
2. Secure the back cover to the wall plugs using screws. Please note the pedestrian direction arrow on the cover when installation.
3. Install the device back to the cover.

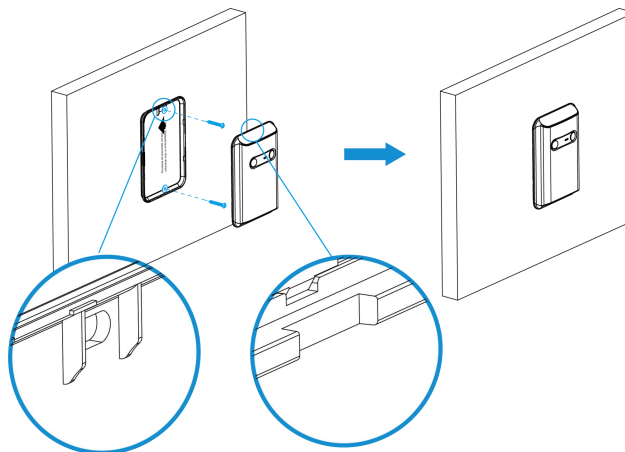

Installation Note:

1. The best installation height is 1.2~1.3m above the ground.
2. The passage detection width of wall mount should not more than 2.3m.
3. The optimal operating temperature range is between 15°C and 32°C, so keep the device away from heat sources, cold sources, and the areas where airflow varies greatly like areas with windows, vents, fans, and air conditioners.
4. Avoid facing the device to a transparent plate (like glass) as the PIR will detect through it.

5.2 Factors Affecting Accuracy

- Two or more people within the distance of 50cm will be counted as one person or reversed.
- Animals or other moving objects will be counted if they are close to the device.
- Walking in an extremely slow speed may lead to data not being recorded.
- Places where temperature changes abruptly above 5°C, can easily lead to counting error.

6. Device Payload

All the data is based on the following format (HEX), the Data field should follow the little-endian:

Channel1	Type1	Data1	Channel2	Type2	Data2	Channel 3	...
1 Byte	1 Byte	N Bytes	1 Byte	1 Byte	M Bytes	1 Byte	...

For decoder examples please find the files on

<https://github.com/Milesight-IoT/SensorDecoders>.

6.1 Basic Information

VS350 sensor reports basic information whenever it joins the network.

Channel	Type	Description
ff	0b (Power On)	Device is on
	01 (Protocol Version)	01=>V1
	16 (Device SN)	16 digits
	09 (Hardware Version)	01 40 => V1.4
	0a (Software Version)	01 14 => V1.14
	0f (Device Type)	00: Class A, 01: Class B, 02: Class C

Example:

ff0bff ff0101 ff166791d19604050005 ff090100 ff0a0101 ff0f00					
Channel	Type	Value	Channel	Type	Value
ff	0b (Power On)	ff (Reserved)	ff	01 (Protocol Version)	01 (V1)
Channel	Type	Value	Channel	Type	Value
ff	16 (Device SN)	6791d19604050 005	ff	09 (Hardware Version)	0100 (V1.0)
Channel	Type	Value	Channel	Type	Value
ff	0a (Software Version)	0101 (V1.1)	ff	0f (Device Type)	00 (Class A)

6.2 Sensor Data

Item	Channel	Type	Description
Battery Level	01	75	UINT8, Unit: %
Temperature	03	67	INT16/10, Unit: °C
Accumulated Counter	04	cc	Accumulated In (2B) + Accumulated Out (2B)
Periodic Counter	05	cc	Periodic In (2B) + Periodic Out (2B)
Temperature Alarm	83	67	Temperature (2B)+ Alarm Type (1B) Byte 1-2: temperature Byte 3: alarm type 00 -Threshold Alarm Release 01 -Threshold Alarm 03 - High Temperature Alarm: temp > 32°C 04 - High Temperature Alarm Release
Accumulated Counter Alarm	84	cc	Accumulated In (2B) + Accumulated Out (2B) + 01
Periodic Counter Alarm	85	cc	Periodic In (2B) + Periodic Out (2B)+01

Examples:

1. Periodic packet: report as reporting interval (10 minutes by default).

017562 0367d000 04cc0c000700 05cc01000000					
Channel	Type	Value	Channel	Type	Value
01	75 (Battery Level)	62=>98%	03	67 (Temperature)	d0 00=>00 d0=208 Temp=208/10=20.8°C
Channel	Type	Value	Channel	Type	Value
04	cc	Accumulated In: 0c 00=> 00 0c=12 Accumulated Out: 07 00=>00 07=7	05	cc	Periodic In: 01 00=> 00 01=1 Periodic Out: 00 00=0

2. People alarm packet: report when the counting value reaches the threshold.

84 cc 0200000001		
Channel	Type	Value
84	cc	Accumulated in: 0200=>0002=2 Accumulated out: 0000=0

		01= Threshold Alarm
--	--	---------------------

3. Temperature alarm packet: report when the temperature reaches the threshold or is above 32°C.

83670e0101		
Channel	Type	Value
83	67	Temperature: 0e 01 =>01 0e = 270 /10 = 27 °C 01= Threshold Alarm

6.3 Downlink Commands

VS350 supports downlink commands to configure the device. The application port is 85 by default.

Item	Channel	Type	Description
Reboot		10	ff
Threshold Alarm	ff	06	9 Bytes, CTRL(1B)+Min(2B)+Max(2B)+00000000(4B) CTRL: Bit0~Bit2: 000-disable 001-below (minimum threshold) 010-above (maximum threshold) 011-within 100-below or above Bit3~Bit5: 001-in/out threshold 010-accumulated in/out threshold 011-temperature threshold Bit6~Bit7: 11
Reporting Interval		8e	3 Bytes, Byte 1: 00 Byte 2-3: interval time, unit: min
Reset Accumulated Value		a6	00: disable, 01: enable
Reset Interval		a7	2 Bytes, unit: min
Reset Accumulated Value		a8	01: reset accumulate in value 02: reset accumulate out value
Report Accumulated Value		a9	00: disable, 01: enable

Report Temperature	aa	00: disable, 01: enable
Temperature Calibration	ab	3 Bytes, Byte 1: 00-disable, 01-enable Byte 2-3: calibration value*10
Data Storage	68	00: disable, 01: enable
Data Retransmission	69	00: disable, 01: enable
Data Retransmission Interval	6a	3 Bytes Byte 1: 00 Byte 2-3: interval time, unit: s range: 30~1200s (600s by default)
Milesight D2D Feature	84	00: disable; 01: enable
Milesight D2D Key	35	First 16 digits, last 16 digits are fixed as 0
Milesight D2D Settings	96	8 Bytes, Byte 1: 01-Someone Entered 02-Someone Left 03-People Counting Threshold Triggered 04-Temperature threshold triggered 05-Temperature threshold is released Byte 2: 00-disable, 01-enable Byte 3: 00-disable LoRa Uplink, 01-enable LoRa Uplink Byte 4-5: D2D control command Byte 6-7: control time, unit: min Byte 8: 00-disable control time, 01-enable control time

Examples:

1. Reboot the device.

ff10ff		
Channel	Type	Value
ff	10 (Reboot)	ff (Reserved)

2. Set reporting interval as 2 minutes.

ff8e 00 0200		
Channel	Type	Value

ff	8e (Reporting Interval)	02 00=>00 02=>2 mins
----	-------------------------	----------------------

3. Set reset interval as 5 minutes.

ffa7 0500		
Channel	Type	Value
ff	a7 (Reset Interval)	05 00=>00 05=>5 mins

4. Enable temperature and set calibration value.

ffab01fdff		
Channel	Type	Value
ff	ab (Temperature Calibration)	01=Enable fdff=>fffd=-3*0.1=-0.3

5. Set D2D Key as 5572404C696E6B4C0000000000000000.

ff35572404C696E6B4C		
Channel	Type	Value
ff	35 (Set D2D Key)	5572404C696E6B4C

6. Set D2D settings.

ff96 03 01 01 04e0 0500 01		
Channel	Type	Value
ff	96 (D2D Settings)	03=> People counting threshold triggered; 01=>Enable; 01=>Enable LoRa Uplink; 04 e0=>e0 04, Control Command is e0 04; 05 00=>00 05, Control time is 5 mins; 01=>Enable Control Time

5. Set temperature threshold alarm.

ff06 dc 9600 2c01 00000000		
Channel	Type	Value
ff	06 (Threshold Alarm)	Ctrl: dc=>11 011 100 100=below or above Min_value: 96 00=>00 96=15°C Max_value: 2c 01=>01 2c=30°C

6.4 Historical Data Enquiry

VS350 supports sending downlink commands to enquire historical data for a specified time point or time range. Before that, ensure **the device time is correct and the data storage feature was enabled to store the data.**

Command format:

Channel	Type	Description
fd	6b (Enquire data in time point)	4 Bytes, Unix timestamp
fd	6c (Enquire data in time range)	Start time (4 bytes) + End time (4 bytes), Unix timestamp
fd	6d (Stop query data report)	ff
ff	6a (Report Interval)	3 Bytes, Byte 1: 01 Byte 2: interval time, unit: s, range: 30~1200s (60s by default)

Reply format:

Channel	Type	Description
fc	6b/6c	1 Byte, 00: data enquiry success 01: time point or time range invalid 02: no data in this time or time range
20	ce (Historical Data)	9 Bytes, Data time stamp (4 Bytes) + Count Type (1 Byte) + Periodic In Count (2 Bytes) + Periodic Out Count (2 Bytes) + Accumulated In Count (2 Bytes) + Accumulated Out Count (2 Bytes) Counter Type: 00 - Periodic Counter 01 - Periodic Counter + Accumulated Counter

Note:

1. The device only uploads no more than 300 data records per range enquiry.
2. When enquiring the data in a specific time point, it will upload the data which is the closest to the search point within the reporting interval range. For example, if the device's reporting interval is 10 minutes and users send a command to search for data stored at 17:00, it will upload these data, if the device finds any data stored in 17:00. If not, it will search for data between 16:50 to 17:10 and upload the data which is the closest to 17:00.

Example:

1. Enquire historical data between 2023/8/28 13:30:00 to 2023/8/28 13:40:00.

fd6cd830ec643033ec64

Channel	Type	Value
fd	6c (Enquire data in time range)	Start time: d830ec64=> 64ec30d8 = 1693200600s = 2023/8/28 13:30:00 End time: 3033ec64 => 64cc3330 = 1693201200s = 2023/8/28 13:40:00

Reply:

fc6c00		
Channel	Type	Value
fc	6c (Enquire data in time range)	00: data enquiry success

20ce 1932ec64 01 0700 0300 4a00 3800			
Channel	Type	Time Stamp	Value
20	ce (Historical Data)	1932ec64 => 64ec3219 = 1693200921s = 2023/8/28 13:35:21	01=Periodic Counter + Accumulated Counter Period In: 0700=>0007=7 Period Out: 0300=>0003=3 Accumulated In: 4a00=>004a=74 Accumulated Out: 3800=>0038=56

-END-