



Indoor Ambiance Monitoring Sensor

AM102(L)

User Guide

Contents

Chapter 1. Preface.....	4
Chapter 2. Product Introduction.....	6
Overview.....	6
Features.....	6
Chapter 3. Hardware Introduction.....	7
Packing List.....	7
Hardware Overview.....	7
E-ink Screen (AM102 Only).....	8
Button and LED Indicator.....	8
Dimensions (mm).....	9
Chapter 4. Power Supply.....	10
Chapter 5. Operation Guide.....	11
Access the Sensor.....	11
Access the Sensor via NFC.....	11
LoRaWAN Settings.....	11
Time Synchronization.....	14
General Settings.....	15
Calibration Settings.....	19
Threshold Settings.....	20
Maintenance.....	20
Upgrade.....	20
Backup and Restore.....	21
Reset to Factory Default.....	23
Chapter 6. Installation.....	25
Fixed by Screws.....	25
Fixed by 3M Tape.....	26
Chapter 7. Battery Replacement.....	27

Chapter 8. Uplink and Downlink	28
Overview.....	28
Uplink Data.....	28
Basic Information.....	29
Periodic Report.....	29
Alarm Report.....	30
Historical Data.....	30
Downlink Command.....	30
General Settings.....	30
Time Settings.....	31
Screen Display Settings.....	32
Historical Data Enquiry.....	33
Chapter 9. Services	36

Chapter 1. Preface

Copyright Statement

This guide may not be reproduced in any form or by any means to create any derivative such as translation, transformation, or adaptation without the prior written permission of Xiamen Milesight IoT Co., Ltd (Hereinafter referred to as Milesight).

Milesight reserves the right to change this guide and the specifications without prior notice. The latest specifications and user documentation for all Milesight products are available on our official website <http://www.milesight.com>

Safety Instruction

These instructions are intended to ensure that user can use the product correctly to avoid danger or property loss. Milesight will not shoulder responsibility for any loss or damage resulting from not following the instructions of this operating guide.

**CAUTION:**

Injury or equipment damage may be caused if any of these cautions are neglected.

- The device must not be disassembled or remodeled in any way.
- In order to protect the security of the device, please change device password when first configuration. The default password is 123456.
- Do not place the device outdoors where the temperature is below/above operating range. Do not place the device close to objects with naked flames, heat source (oven or sunlight), cold source, liquid and extreme temperature changes.
- The device is not intended to be used as a reference sensor, and Milesight will not should responsibility for any damage which may result from inaccurate readings.
- The batteries should be removed from the device if it is not to be used for an extended period. Otherwise, the batteries might leak and damage the device. Never leave discharged batteries in the battery compartment.
- The device must never be subjected to shocks or impacts.
- Do not clean the device with detergents or solvents such as benzene or alcohol. To clean the device, wipe with a soft moistened cloth. Use another soft, dry cloth to wipe dry.

Revision History

Release Date	Version	Description
Aug. 31, 2023	V1.0	Initial version
Nov. 20, 2025	V1.1	Battery pre-installed in the device and removed from packing list.

Chapter 2. Product Introduction

Overview

AM102(L) is a compact indoor ambience monitoring sensor for measurement of temperature and humidity. These data will be shown on the E-ink screen in real-time, which allow to quantify the indoor environment and comfort.

Apart from screen display, sensor data can also be transmitted using LoRaWAN[®]. With this low-power technology, AM102(L) can work for more than 7 years with 2 replaceable batteries. Combining with Milesight LoRaWAN[®] gateway and Milesight Development Platform solution, users can manage all sensor data remotely.

AM102(L) can be used in office, store, classroom, hospital, etc.

Features

- Uses Sensirion high-precision sensor, capable of sensing subtle changes in temperature and humidity
- Visual data to understand the environment easily via E-ink screen
- Smart hibernate mode schedulely to save battery power
- Store locally historical records and support retransmission to prevent data loss
- Built-in NFC for easy configuration
- Compliant with standard LoRaWAN[®] gateways and network servers
- Quick and easy management with Milesight IoT Cloud and Milesight Development Platform

Chapter 3. Hardware Introduction

Packing List

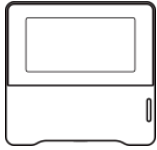

1 × AM100(L)
Series Sensor

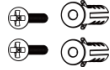

2 × Wall Mounting Kits



1 × 3M Double-Sided Tape



1 × Theft-Deterrent Screw



1 × Quick Guide



1 × Warranty Card





Note:

If any of the above items is missing or damaged, please contact your sales Representative.

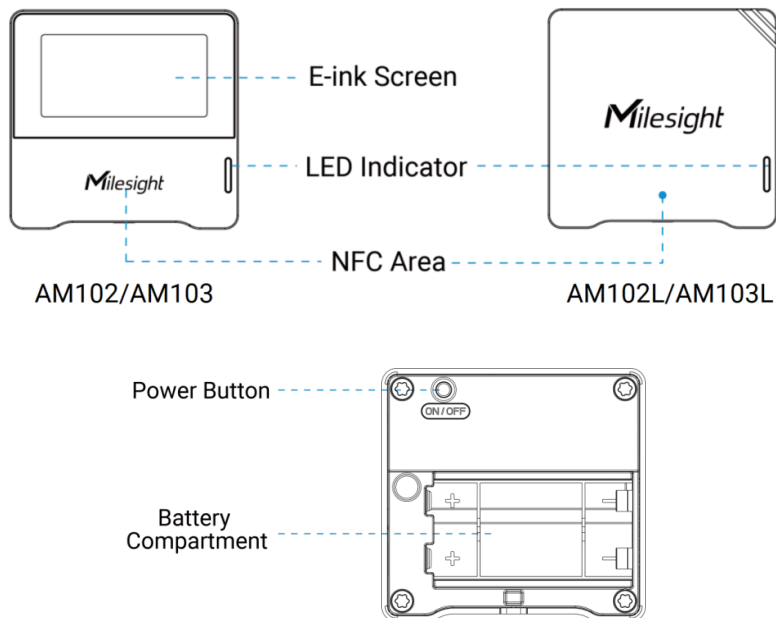
Hardware Overview



E-ink Screen (AM102 Only)

Icon	Description
	Battery level
Last Update 22:22	The time of the last collected and updated sensor data
	The device has joined the network
	The device has not joined the network
20.3°C	Temperature
58.3% RH	Humidity

**Note:**

- The device will update data on the screen every 2 minutes if [Screen Smart Mode](#) is disabled;
- The device will do a full-screen refresh every 30 minutes in order to remove ghosting.
- When the device detects the temperature beyond the range from 0°C to 40°C, the screen will close automatically.

Button and LED Indicator

Function	Action	LED Indicator
Power ON/OFF	Press and hold the power button for more than 3 seconds.	Power On: Off → On
		Power Off: On → Off

Function	Action	LED Indicator
Reset to Factory Default	Press and hold the power button for more than 10 seconds.	Quickly Blinks
Check On/Off Status	Quickly press the power button once.	Light On: Device is on.
		Light Off: Device is off.

Dimensions (mm)

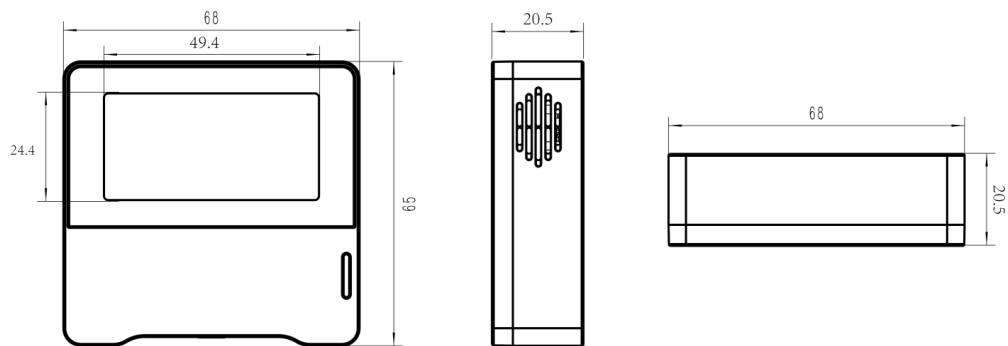

Chapter 4. Power Supply

1. Remove the back cover.

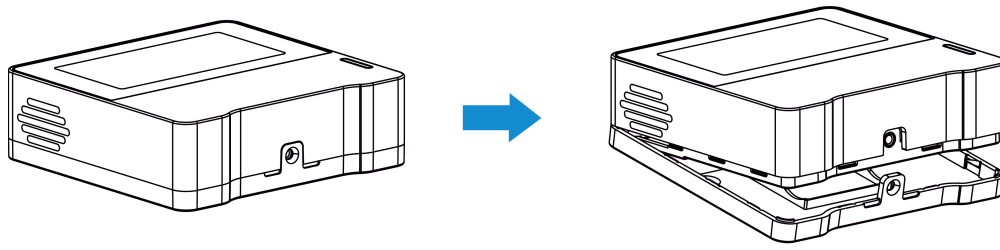

2. Take out the battery insulation sheet, and then long press the power button for 3s to turn on the device.

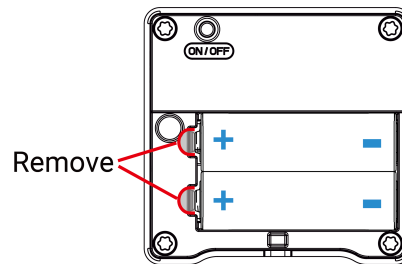

Chapter 5. Operation Guide

Access the Sensor

Access the Sensor via NFC

1. Download and install “Milesight ToolBox” App from Google Play or Apple Store on an NFC-supported smartphone.
2. Enable NFC function on the smartphone.
3. Launch Milesight ToolBox, and select the default mode as NFC.
4. Attach the smart phone with NFC area to the device and click  to read device information. Basic information, data, and settings of the device will be shown on the Milesight ToolBox App if it's recognized successfully.
5. Adjust the settings on the App, then attach the smartphone with NFC area to the device and click **Write** to write the settings. After writing, reread the device to check if the configuration is written well.



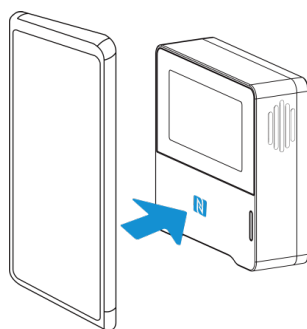

Note:

- Ensure the location of smartphone NFC area and it's recommended to take off phone case.
- If the smart phone fails to read/write configurations via NFC, keep the phone away and back to try again.
- The default device password is 123456. Please change a new password for security.



LoRaWAN Settings

This chapter describes the LoRaWAN[®] network settings of device.

Parameter	Description
Device EUI	<p>Unique ID of the device which can be found on the device.</p> <p> Note: please contact sales for device EUI list if you have many units.</p>
App EUI	The default App EUI (join EUI) is 24E124C0002A0001.
Application Port	The port used for sending and receiving data, the default port is 85.
LoRaWAN [®] Version	V1.0.2 and V1.0.3 are available.
Work Mode	It's fixed as Class A.
Confirmed Mode	If the device does not receive ACK packet from network server, it will resend data once.
Join Type	<p>OTAA and ABP mode are available.</p> <p> Note: it's necessary to select OTAA mode if connecting device to Milesight IoT Cloud or Milesight Development Platform.</p>
Application Key	<p>Appkey for OTAA mode, default value: "Device EUI" + "Device EUI" (since Q4 of 2025). Example: 24e124123456789024e1241234567890</p> <p> Note:</p> <ul style="list-style-type: none"> • The default value of earlier devices is 5572404C696E6B4C6F52613230313823. • Please contact sales before purchase if you require random App Keys.
Network Session Key	Nwkskey for ABP mode, the default is 5572404C696E6B4C6F52613230313823.

Parameter	Description
Application Session Key	Appkey for ABP mode, the default is 5572404C696E6B4C6F52613230313823.
Device Address	DevAddr for ABP mode, default is the 5 th to 12 th digits of SN.
Rejoin Mode	<p>Reporting interval ≤ 35 mins: the device will send a specific number of Link-CheckReq MAC packets to the network server every reporting interval or every double reporting interval to validate connectivity; If there is no response, the device will re-join the network.</p> <p>Reporting interval > 35 mins: the device will send a specific number of Link-CheckReq MAC packets to the network server every reporting interval to validate connectivity; If there is no response, the device will re-join the network.</p> <div data-bbox="513 840 1414 1121" style="background-color: #e6f2ff; padding: 10px; border: 1px solid #add8e6;"> <p> Note:</p> <ol style="list-style-type: none"> 1. Only OTAA mode supports rejoin mode. 2. The actual sending number is Set the number of packets sent +1. </div>
Channel Mode	Select Standard-Channel mode or Single-Channel mode. When Single-Channel mode is enabled, only one channel can be selected to send uplinks.
Supported Frequency	<p>Enable or disable the frequency to send uplinks. If frequency is one of CN470/AU915/US915, enter the index of the channel to enable in the input box, making them separated by commas.</p> <p>Examples:</p> <p>1, 40: Enabling Channel 1 and Channel 40</p> <p>1-40: Enabling Channel 1 to Channel 40</p> <p>1-40, 60: Enabling Channel 1 to Channel 40 and Channel 60</p> <p>All: Enabling all channels</p> <p>Null: Indicate that all channels are disabled</p>

Parameter	Description
ADR Mode	Enable or disable network server to adjust Spreading Factor, Bandwidth an Tx Power to optimize data rates, airtime and energy consumption in the network.
Spreading Factor	If ADR mode is disabled, the device will send uplink data following this SF parameter. The higher the spreading factor, the longer the transmission distance, the slower the transmission speed and the more the consumption.
Tx Power	Tx power (transmit power) refers to the strength of the outgoing signal transmitted by the device. This is defined by LoRa alliance.
RX2 Data Rate	RX2 data rate to receive downlinks.
RX2 Frequency	RX2 frequency to receive downlinks. Unit: Hz

Time Synchronization

This section describes how to sync the time of the device.

Sync via ToolBox App

After reading the device via Milesight ToolBox App, sync the device time with time zone from the smart phone.

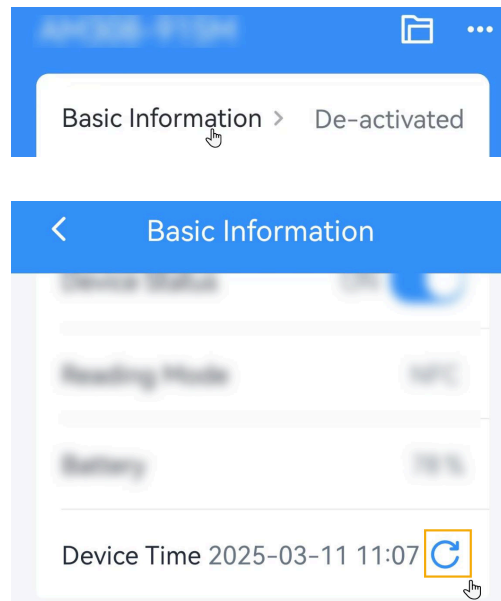

Sync via Network Server

This requires to ensure the LoRaWAN[®] network server supports device time synchronization feature. Example: Milesight gateway embedded NS.

1. Set the LoRaWAN[®] version of the device to V1.0.3.
2. Connect the device to the network server. After joining the network, the device will send a DeviceTimeReq MAC command to enquire the time from network server.

**Note:**

- This only supports to get the time but not time zone. The time zone can be configured by ToolBox App or downlink command.
- The device will send the DeviceTimeReq command every 5 days since the last sync.

General Settings

General settings include the basic parameters of the device.

Temperature Unit [i](#)

°C

Reporting Interval 10 min

LED Indicator [i](#)



Data Storage [i](#)

Data Retransmission [i](#)

Change Password

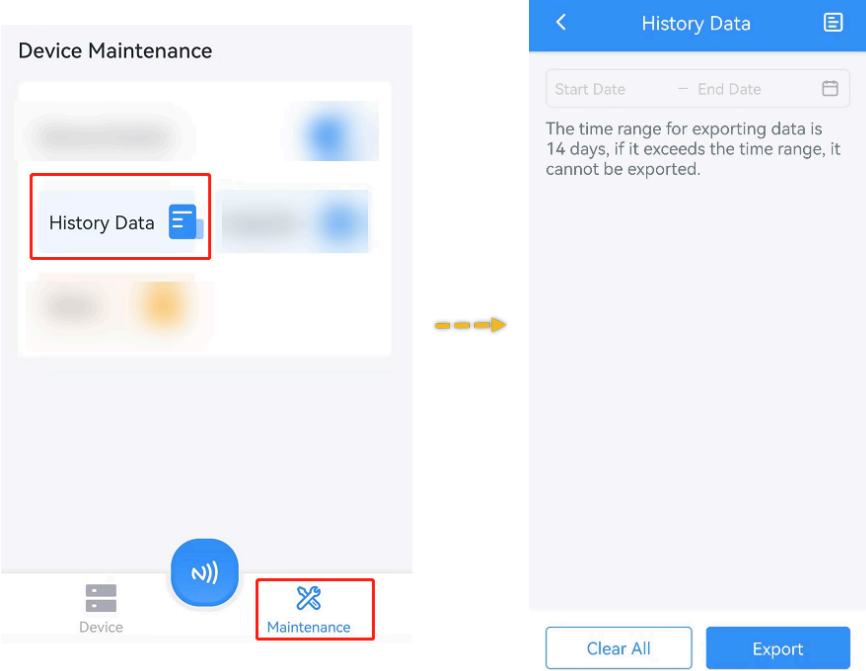
Parameter	Description
Temperature Unit	Change the temperature unit displayed on the ToolBox and screen.

Parameter	Description
	<p> Note:</p> <ol style="list-style-type: none"> 1. The temperature unit in the reporting package is fixed as Celsius(°C). 2. Please modify the threshold settings if the unit is changed.
Reporting Interval	Reporting interval of transmitting current sensor values to network server. Default: 10 mins, Range: 1-1080 mins.
LED Indicator	Enable or disable the indicator to blink every 13s to indicate the device running well.
Data Storage	<p>Disable or enable to store periodic report data locally. The stored data can be exported as CSV format file and saved to smartphone via Toolbox.</p> 

Parameter	Description
	<p> Note:</p> <ol style="list-style-type: none"> 1. It is necessary to sync the time to ensure the data is stored in correct time. 2. The device will still store the data even the network status is de-activated. 3. ToolBox App can only export the last 14 days' data at most.
Data Retransmission	<p>Disable or enable data retransmission. When the device detects the network status is de-activated via Rejoin Mode, the device will record a data lost time point and re-transmit the lost data after device re-connects to the network.</p> <p> Note:</p> <ol style="list-style-type: none"> 1. This setting only takes effect when Data Storage is enabled. 2. If the device is rebooted or re-power when data retransmission is not completed, the device will re-send all retransmission data again after device is reconnected to the network. 3. If the network is disconnected again during data retransmission, it will only send the latest disconnected data. 4. The default report data retransmission interval is 600s, this can be changed via downlink command. 5. The reported format of retransmission data will include timestamps and is different from periodic report data. 6. This setting will increase the uplink frequencies and shorten the battery life.
Change Password	Change the password for ToolBox App to write this device.

Screen Settings (AM102 Only)

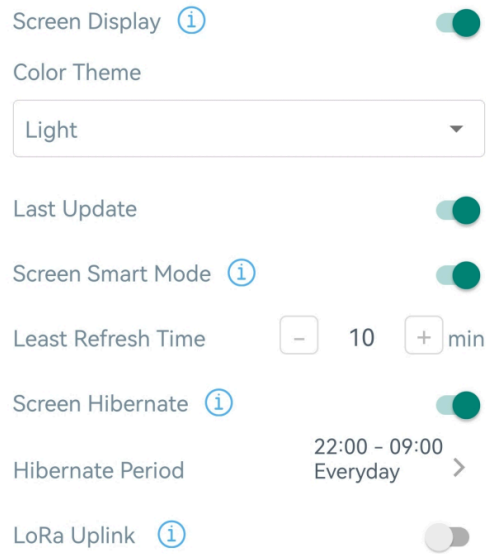

Parameters	Description
Screen Display	Enable or disable screen display.
Color Theme	Select screen display background color as Light or Dark.
Last Update	Enable or disable the Last Update time displayed on the screen.
Screen Smart Mode	When the new collected value is close to the last value (temperature $\leq \pm 0.5^{\circ}\text{C}$, humidity $\leq \pm 3\%$), the screen will stop updating corresponding value to save power. Least Refresh Time: Set the least time to fresh the screen. Range: 2-1080 mins
Screen Hibernate	Enable the screen to hibernate during a time period. Hibernate Period: Set the period of screen hibernate.

Parameters	Description
	<div data-bbox="618 268 976 831"> <p>Hibernate Period</p> <p> 22:00 09:00</p> <p>Repeat</p> <ul style="list-style-type: none"> Every Mon <input checked="" type="radio"/> Every Tue <input checked="" type="radio"/> Every Wed <input checked="" type="radio"/> Every Thu <input checked="" type="radio"/> Every Fri <input checked="" type="radio"/> Every Sat <input checked="" type="radio"/> Every Sun <input checked="" type="radio"/> </div> <p>LoRa Uplink: Enable or disable to send LoRaWAN[®] uplinks during hibernate. It's disabled by default.</p>

Calibration Settings

Temperature Calibration

Set the calibration value, the device will add calibration value to the current temperature value, then display and report the final value.

Temperature

Numerical Calibration

Current Value: 24.4 °C

Calibration Value

°C

Final Value: 24.3 °C

Humidity Calibration

Set the calibration value, the device will add calibration value to the current humidity value, then display and report the final value.

Humidity 

Numerical Calibration

Current Value: 57.5 %

Calibration Value

%

Final Value: 56.5 %

Threshold Settings

Temperature threshold

The device will upload the current data once instantly when temperature is over or below the threshold. Only when the threshold is released and triggered again, the device will report the threshold packet again.

Temperature 

Over / °C

Below / °C

Maintenance

Upgrade

This chapter describes the steps to upgrade the device via ToolBox App.

1. Download firmware from Milesight official website to your smartphone.
2. Read the target device via ToolBox App, click **Upgrade** to upload the firmware file.
3. Click **Upgrade** to upgrade the device.



Note:

- Operation on ToolBox is not supported during an upgrade.
- Only Android version ToolBox supports the upgrade feature.

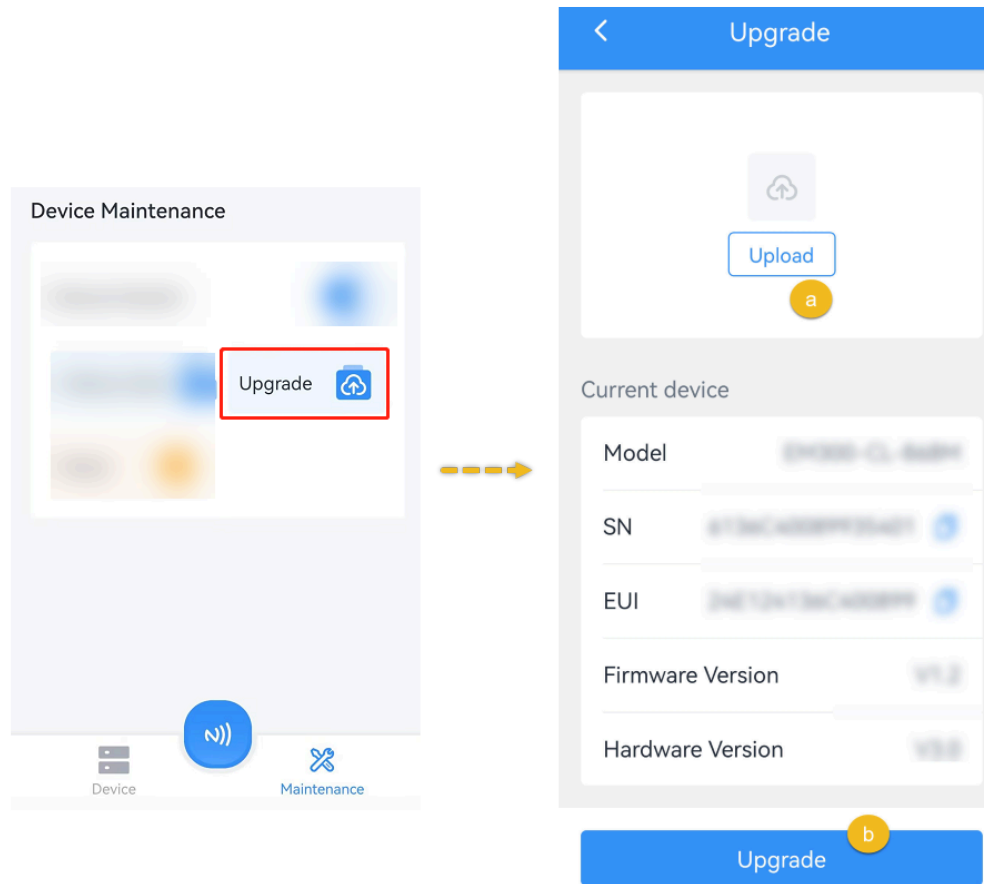

Backup and Restore

This device supports configuration backup for easy and quick device configuration in bulks. Backup and restore is allowed only for devices with the same model and frequency band.

Backup and Restore

1. Launch ToolBox App, attach the NFC area of smartphone to the device to read the configuration.
2. Edit the configuration as required, click **Set Template** to save current configuration as a template to the ToolBox App.

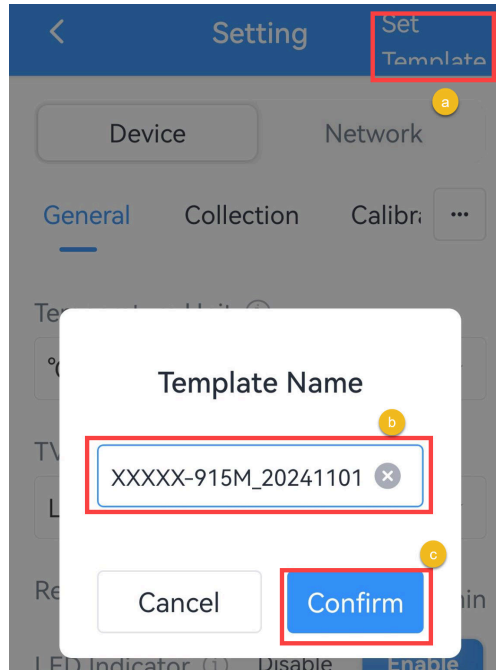

3. Go to **Device >Template** page.



4. Select and click the target template, click **Write** to import the configuration to target devices.

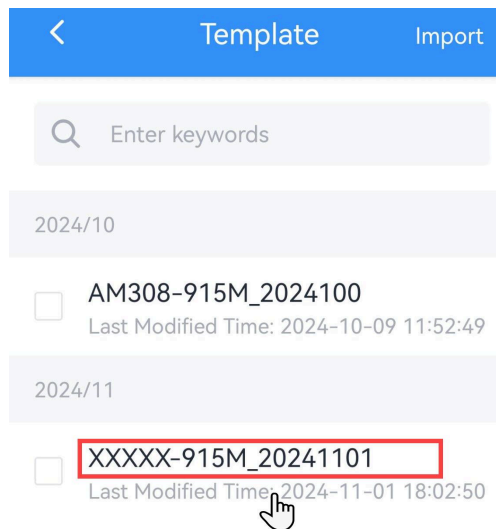

Export and Delete Template

1. Check the box of the target template.
2. Click **Export** to export this template as JSON format file and save it to the smartphone, click **Delete** to delete this template from your Toolbox App.

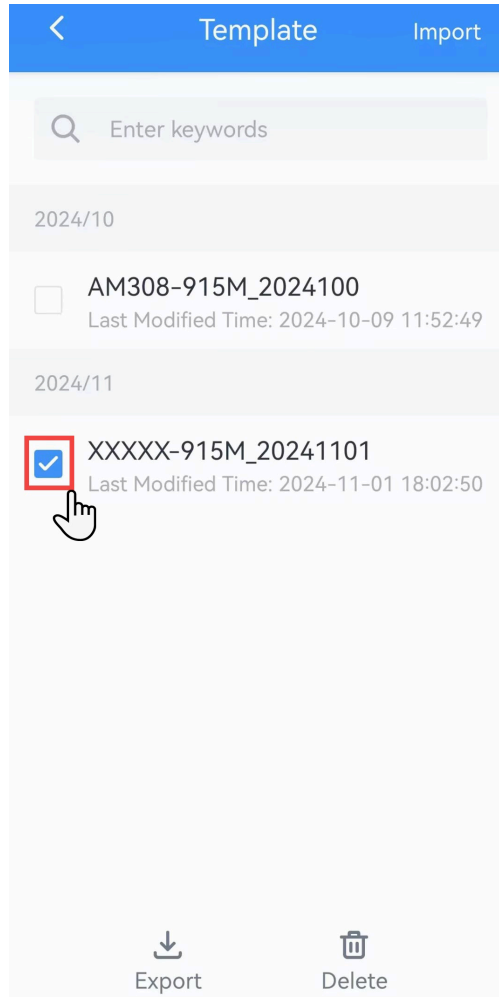

Reset to Factory Default

Via Hardware: Hold on the reset button for more than 10s until the LED indicator quickly blinks.

Via Toolbox App: Click **Reset** and attach the smartphone to device to reset the device.

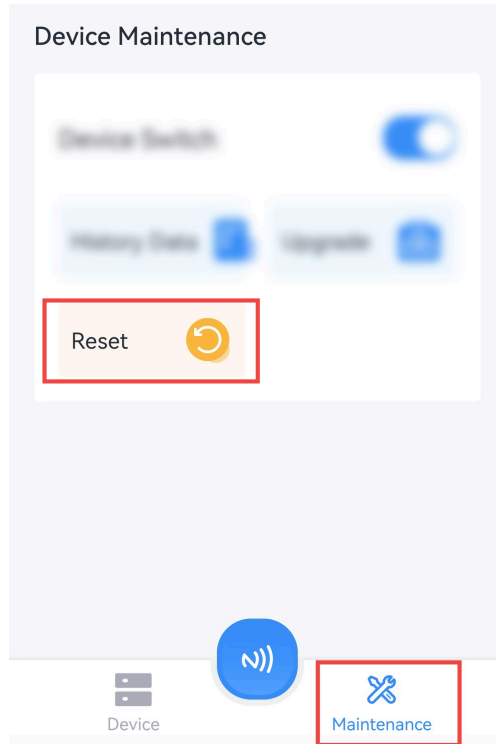

Chapter 6. Installation

Installation Locations

In order to ensure the best detection and LoRaWAN[®] communication work, it is recommended to install device as follows:

- Do not mount the device where the temperature is below/above operating range and temperature varies greatly.
- Stay far away from any heat source or cold source like oven, refrigerator.
- Do not mount the device close to where airflow varies greatly like windows, vent, fan and air conditioner.
- Do not mount the device upside down.
- Do not place the device right to the window or door. If you have to, you'd better pull the curtain.
- It is recommended to install at least 1.5 m high from floor.

Fixed by Screws

1. Remove the rear cover of the device, screw the wall plugs into the wall and fix the rear cover with screws on it, then install back the device.

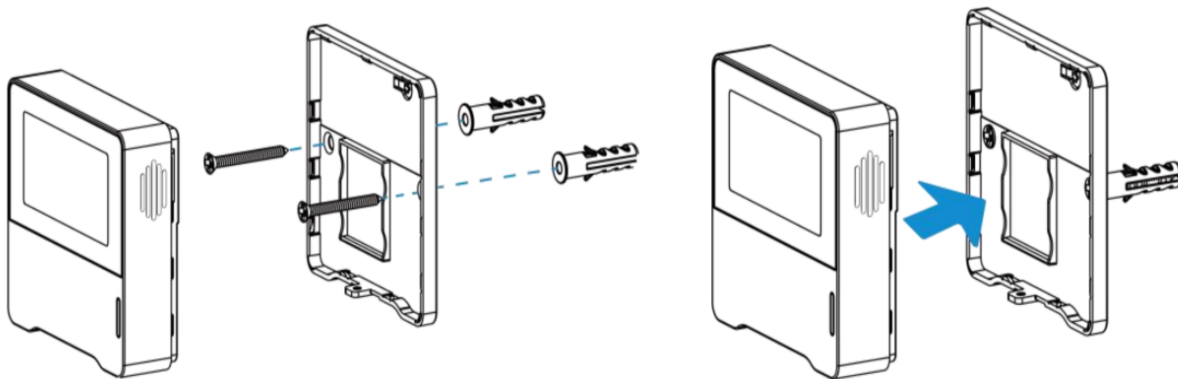

2. Fix the bottom of the device to the rear cover with the theft-detering screw.

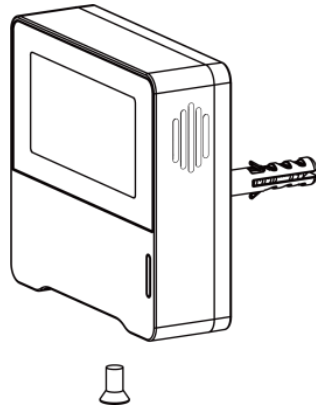

Fixed by 3M Tape

1. Fix the bottom of the device to the rear cover with the theft-deterrent screw.

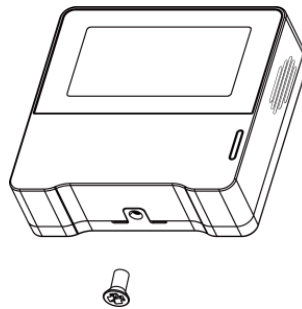

2. Paste 3M double-sided tape to the back of the device, then tear the other side and place it on a flat surface.

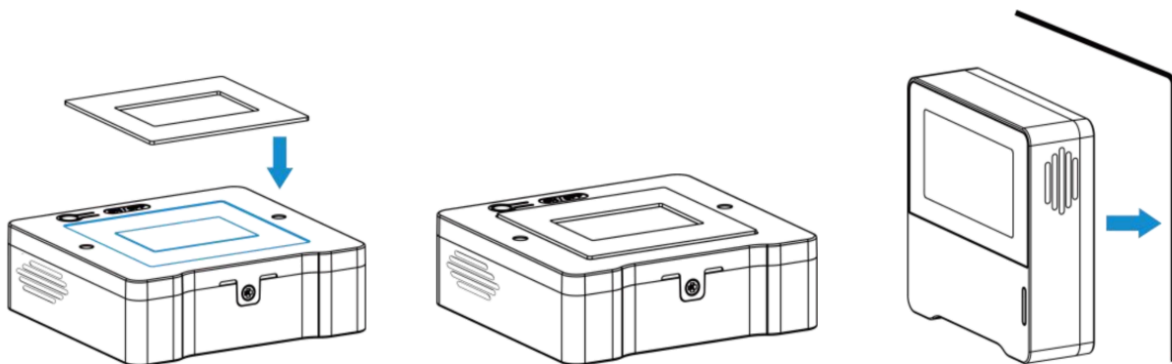

Chapter 7. Battery Replacement

Remove the back cover to replace the battery. Ensure correct polarity when installing.

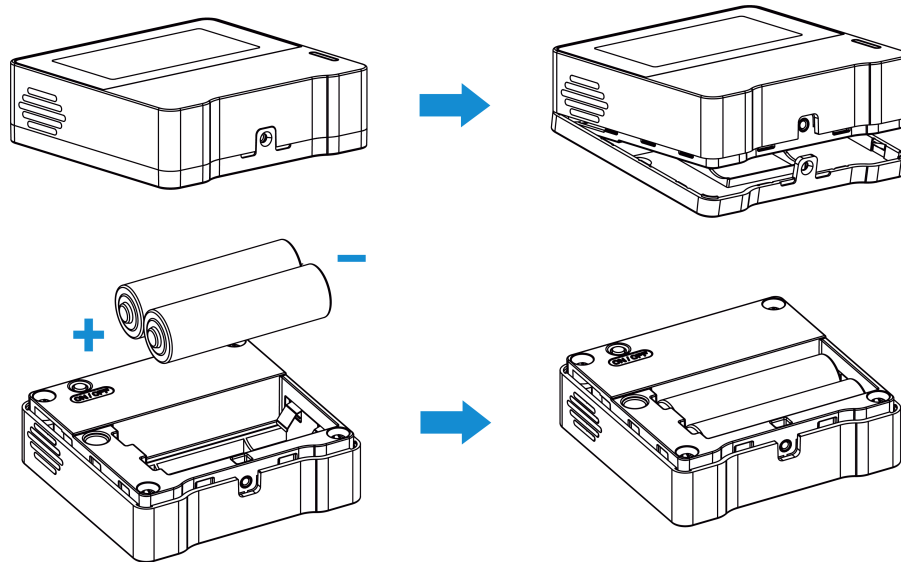

Note:

- The device can only be powered by ER14505 Li-SOCl₂ batteries not alkaline batteries.
- Ensure the battery direction is not reversed.
- Ensure all replacing batteries are newest; otherwise it may shorten battery life or cause inaccurate power calculation.
- The battery should be removed from the device if it is not used for an extended period.

Chapter 8. Uplink and Downlink

Overview

All messages are based on following format (HEX), the Data field should follow little-endian:

Channel1	Type1	Data1	Channel2	Type2	Data2	Channel3	...
1 Byte	1 Byte	N Bytes	1 Byte	1 Byte	N Bytes	1 Byte	...

For decoder examples please find files on <https://github.com/Milesight-IoT/SensorDecoders>.

Uplink Data

This chapter describes the reported data of the device.

Item	Channel	Type	Byte	Description						
Power On	ff	0b	1	Device is on						
Protocol Version	ff	01	1	Example: 01=V1						
Hardware Version	ff	09	2	Example: 03 10 = V3.1						
Software Version	ff	0a	2	Example: 03 01 = V3.1						
Device Type	ff	0f	1	00: Class A, 01: Class B, 02: Class C, 03: Class C to B						
Serial Number	ff	16	8	16 digits						
Sensor Status	ff	18	2	<p>Byte 1: 00</p> <p>Byte 2: 0=disabled, 1=enabled for every bit</p> <table border="1"> <thead> <tr> <th>Bit</th> <th>Sensor</th> </tr> </thead> <tbody> <tr> <td>0</td> <td>Temperature</td> </tr> <tr> <td>1</td> <td>Humidity</td> </tr> </tbody> </table>	Bit	Sensor	0	Temperature	1	Humidity
Bit	Sensor									
0	Temperature									
1	Humidity									
Battery Level	01	75	1	UINT8, Unit: %						
Temperature	03	67	2	INT16/10, Unit: °C						

Item	Channel	Type	Byte	Description
Humidity	04	68	1	UINT8/2, Unit: %RH
Historical Data	20	ce	7	Byte 1-4: Data unix timestamp, UINT32, Unit: s Byte 5-6: Temperature, INT16/10, Unit: °C Byte 7: Humidity, UINT8/2, Unit: %RH

Basic Information

The device will report a basic information packet whenever joining the network.

Example:

ff0bff ff0101 ff166136c40091605408 ff090200 ff0a0101 ff0f00 ff180003		
Channel	Type	Value
ff	0b	ff
ff	01	Protocol version: 01=V1
ff	16	SN: 6136c40091605408
ff	09	Hardware version: 0200=V2.0
ff	0a	Software version: 0101=V1.1
ff	0f	00: Class A
ff	18	03=>0000 0011=Temperature and Humidity sensors enable

Periodic Report

The device supports the sensor data according to reporting interval.

017564 03671001 046871		
Channel	Type	Value
01	75	Battery Level: 64 => 100%
03	67	Temperature: 1001=> 0110 = 272/10=27.2°C
04	68	Humidity: 71 => 113/2=56.5 %RH

Alarm Report

The device supports to report below types of alarm report packets.

1. Temperature threshold alarm: report when threshold alarm is triggered.

03671001		
Channel	Type	Value
03	67	Temperature: 1001=> 0110 = 272/10=27.2°C

2. Low battery level alarm: report when the battery level drops to 1%.

017501		
Channel	Type	Value
01	75	01=1%

Historical Data

The device will report retransmission data or stored data as below example.

20ce 0d755b63 0801 57			
Channel	Type	Time Stamp	Value
20	ce	0d 75 5b 63 => 63 5b 75 0d=1666938125s	Temperature: 0801=>0108=264/10=26.4 °C Humidity: 57=>87/2=43.5%RH

Downlink Command

This device supports downlink commands for configuration and control. The downlink application port is 85 by default.

General Settings

Item	Channel	Type	Byte	Description
Reboot	ff	10	1	ff
Report Interval	ff	03	2	UINT16, Unit: s

Item	Channel	Type	Byte	Description
LED Indicator	ff	2f	1	00: Disable, 01: Enable
Data Storage	ff	68	1	00: Disable, 01: Enable
Data Re-transmission	ff	69	1	00: Disable, 01: Enable
Data Retransmission Interval	ff	6a	3	Byte 1: 00 Byte 2-3: UINT16, Unit: s, Range: 30~1200, Default: 600

Example:

1. Reboot the device.

ff10ff

2. Set report interval as 20 minutes.

ff03b004		
Channel	Type	Value
ff	03	b004=>04b0=1200s=20 minutes

Time Settings

Item	Channel	Type	Byte	Parameter
UTC Time Zone	ff	17	2	INT16/10
Device Time	ff	11	4	Timestamp, UINT32, Unit: s

Examples:

1. Set time zone as UTC-2.

ff17ecff		
Channel	Type	Value
ff	17	ecff=>ff ec=-20/10=-2

Screen Display Settings

Item	Channel	Type	Byte	Description												
Screen Display	ff	2d	1	00: disable, 01: enable												
Last Update Display	ff	85	1	00: disable, 01: enable												
Screen Smart Mode	ff	56	1	00: disable, 01: enable												
Least Refresh Time	ff	86	2	UINT16, Unit: min, Range: 2-1080												
Screen Fresh Time	ff	5a	2	UINT16, Unit: s												
Hibernate Mode	ff	75	6	<p>Byte 1: 00=Disable, 01=Enable</p> <p>Byte 2-3: Start Time, UINT16, Unit: minute, Range: 0-1439</p> <p>Byte 4-5: End Time, UINT16, Unit: minute, Range: 0-1439</p> <p>Byte 6: Repeat weekday, per bit 0=Disable, 1=Enable</p> <table border="1" style="margin-left: 20px;"> <thead> <tr> <th>Bit</th> <th>7</th> <th>6</th> <th>...</th> <th>1</th> <th>0</th> </tr> </thead> <tbody> <tr> <td></td> <td>Sun.</td> <td>Sat.</td> <td>...</td> <td>Mon.</td> <td>All</td> </tr> </tbody> </table> <div style="border: 1px solid #ccc; background-color: #e6f2ff; padding: 5px; margin-top: 10px;"> <p> Note: If start time equals end time, it means all day.</p> </div>	Bit	7	6	...	1	0		Sun.	Sat.	...	Mon.	All
Bit	7	6	...	1	0											
	Sun.	Sat.	...	Mon.	All											

Example:

1. Disable the e-ink screen display.

ff2d00		
Channel	Type	Value
ff	2d	00: Disable the display

2. Enable screen hibernate mode, set the hibernate time between 22:00 to next day 9:00 on week days (Monday to Friday).

ff7501 2805 1c02 3e		
Channel	Type	Value
ff	75	<p>Byte 1: 01 = screen hibernate enable</p> <p>Byte 2-3: 28 05=>05 28=1320 mins =22:00</p> <p>Byte 4-5: 1c 02 => 02 1c = 540 mins =9:00</p> <p>Byte 6: 3e=00111110 => Monday to Friday enable</p>

Historical Data Enquiry

The device supports data retrievability feature to send downlink command to enquire the historical data stored in the device. Before that, ensure the device time is correct and data storage feature was enabled to store data.

Command Format:

Item	Channel	Type	Byte	Description
Enquire Data in Time Point	fd	6b	4	Unix timestamp, Unit: s
Enquire Data in Time Range	fd	6c	8	Byte 1-4: Start timestamp, Unit: s Byte 5-8: End timestamp, Unit: s
Stop Query Data Report	fd	6d	1	ff
Data Retrieval Interval	ff	6a	3	Byte 1: 01 Byte 2-3: UINT16, Unit: s, Range: 30~1200, Default: 60

Reply Format:

Item	Channel	Type	Byte	Description
Enquiry Result	fc	6b/6c	1	00: Enquiry success. The device will report the historical data according to data retrievability interval. 01: Time point or time range invalid 02: No data in this time or time range

**Note:**

1. Use [Unix Timestamp Converter](#) to calculate the time.
2. The device only uploads no more than 300 data records per range enquiry.
3. When enquiring the data in time point, it will upload the data which is closest to the search point within the reporting interval range. For example, if the device's reporting interval is 10 minutes and users send command to search for 17:00's data, if the device find there is data stored in 17:00, it will upload this data; if not, it will search for data between 16:50 to 17:10 and upload the data which is closest to 17:00.

Example:

Enquire the historical data in a time range.

fd6c 64735b63 7c885b63		
Channel	Type	Value
fd	6c	Start time: 64 73 5b 63 => 63 5b 73 64 = 1666937700s End time: 7c 88 5b 63 => 63 5b 88 7c = 1666943100s

Reply:

fc6c00		
Channel	Type	Value
fc	6c	00: Enquiry success

20ce 0d755b63 0801 57			
Channel	Type	Time Stamp	Value
20	ce	0d 75 5b 63 => 63 5b 75 0d=1666938125s	Temperature: 0801=>0108=264/10=26.4 °C Humidity: 57=>87/2=43.5%RH

Chapter 9. Services

Milesight provides customers with timely and comprehensive technical support services. End-users can contact your local dealer to obtain technical support. Distributors and resellers can contact directly with Milesight for technical support.

Technical Support Mailbox: iot.support@milesight.com

Online Support Portal: <https://support.milesight-iot.com>

Resource Download Center: <https://www.milesight.com/iot/resources/download-center/>

MILESIGHT CHINA

TEL: +86-592-5085280

FAX: +86-592-5023065

Add: Building C09, Software Park Phase III, Xiamen 361024, Fujian, China