



CT3xx

Smart Current Transformer

User Guide

Contents

Chapter 1. Preface.....	4
Copyright Statement.....	4
Safety Instruction.....	4
Revision History.....	5
Chapter 2. Product Introduction.....	6
Overview.....	6
Features.....	6
Chapter 3. Hardware Introduction.....	7
Packing List.....	7
Hardware Overview.....	7
Button and LED Indicator.....	7
Dimensions (mm).....	8
Chapter 4. Operation Guide.....	10
Access the Sensor.....	10
LoRaWAN [®] Settings.....	11
Basic Setting.....	11
LoRaWAN Frequency Settings.....	14
Basic & Alarm Settings.....	15
Basic Settings.....	15
Alarm Settings.....	16
Maintenance.....	17
Chapter 5. Installation.....	19
Device Assembly.....	19
Antenna Installation.....	19
Transformer Installation.....	20
Transceiver Installation.....	21
USB-C NTC Sensor Installation (Alternative).....	21

Chapter 6. Uplink and Downlink.....	23
Overview.....	23
Uplink Data.....	23
Basic Information.....	23
Periodic Report.....	24
Alarm Report.....	25
Downlink Command.....	26
General Setting	26
Alarm Setting.....	27
Chapter 7. Services.....	30

Chapter 1. Preface

Copyright Statement

This guide may not be reproduced in any form or by any means to create any derivative such as translation, transformation, or adaptation without the prior written permission of Xiamen Milesight IoT Co., Ltd (Hereinafter referred to as Milesight).

Milesight reserves the right to change this guide and the specifications without prior notice. The latest specifications and user documentation for all Milesight products are available on our official website <http://www.milesight.com>

Safety Instruction

These instructions are intended to ensure that user can use the product correctly to avoid danger or property loss. Milesight will not shoulder responsibility for any loss or damage resulting from not following the instructions of this operating guide.



CAUTION:

Injury or equipment damage may be caused if any of these cautions are neglected.

- The device is not intended to be used as a reference sensor, and Milesight will not should responsibility for any damage which may result from inaccurate readings.
- The installation and maintenance must be conducted by a qualified service person and should strictly comply with the electrical safety regulations of the local region.
- Do not overload the maximum capacity to avoid damage to the device.
- The device must not be disassembled or remodeled in any way.
- Do not place the device close to objects with naked flames, heat source (oven or sunlight), cold source, liquid and extreme temperature changes.
- The device is intended only for indoor use. Do not place the device where the temperature is below/above the operating range.
- Keep the device away from water to prevent electric shock.
- Use the device opening clean and free of dust before installation. Dusty or dirty environments may prevent the proper operation of this device.
- Do not drop the device or subject it to physical shocks and strong vibration.

Revision History

Release Date	Version	Revision Content
June 6, 2024	V1.0	Initial version
Feb. 26, 2025	V1.1	Add CT303.

Chapter 2. Product Introduction

Overview

CT3xx is a LoRaWAN[®] Smart Current Transformer for monitoring energy consumption and analyzing usage remotely. CT3xx provides multiple current options to suit energy monitoring and supports sending threshold alarms. Its compact size enables quick and safe installation in any indoor space without de-energizing facilities, thereby simplifying the installation and saving costs. Compliant with Milesight LoRaWAN[®] gateway and Milesight Development Platform solution, CT3xx can be conveniently monitored via webpage remotely.

CT3xx is widely used for energy motoring of smart buildings, machine failure detection and prevention, etc.

Features

- Report the RMS current and accumulated current data by minutes
- High measuring accuracy with a sampling frequency of up to 3.3 kHz
- Self-powered, free from batteries or external wires
- Utilize a sampling rate of up to 1s for real-time monitoring and quick alarm response
- Non-invasive clamp design ensures easy and safe installation without the need for power de-energizing
- Equipped with LED indicator to indicate working status and alarms
- Support external wire temperature sensor for cable temperature measurement
- Enable simultaneous detection of three phases with a significantly wide optional detection range of 300A, 500A or 1000A
- Compliant with standard LoRaWAN[®] gateways and network servers
- Compliant with Milesight Development Platform
- Support Firmware Update Over the Air (FUOTA)

Chapter 3. Hardware Introduction

Packing List

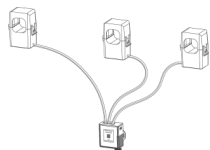

1 × CT3xx Current Transformer

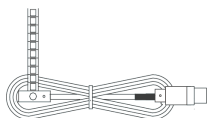

1 × USB-C NTC Sensor (1m)



1 × LoRaWAN[®] Stubby Antenna



1 × LoRaWAN[®] Magnetic Antenna (Optional)



1 × Quick Guide



1 × Warranty Card



Note:

If any of the above items are missing or damaged, please contact your sales representative.

Hardware Overview

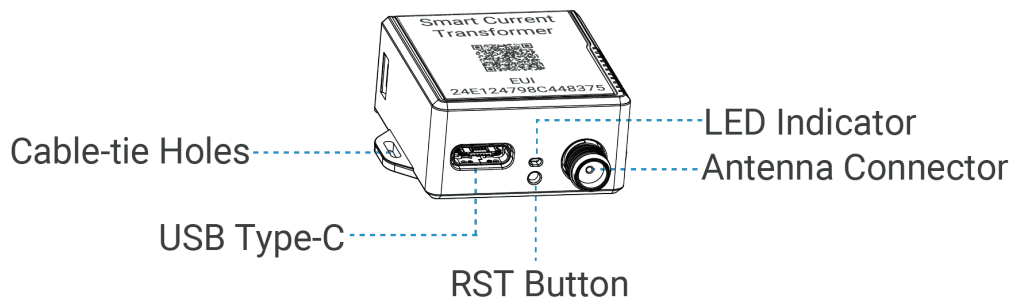

Button and LED Indicator

Function	Action	LED Indicator
Normal Work	The device is functioning properly.	Green light blinking every 2s
Low Power Mode	The device measures and reports at reduced rate.	Green light blinking every 5s
Low Voltage Mode	The device only measures at reduced rate.	Green light blinking every 10s

Function	Action	LED Indicator
Alarm	The current is over the threshold or measuring range, or the temperature is over the threshold.	Red light fast blinking
Reboot	Quick press the RST button once.	Green light blinking Once

Dimensions (mm)

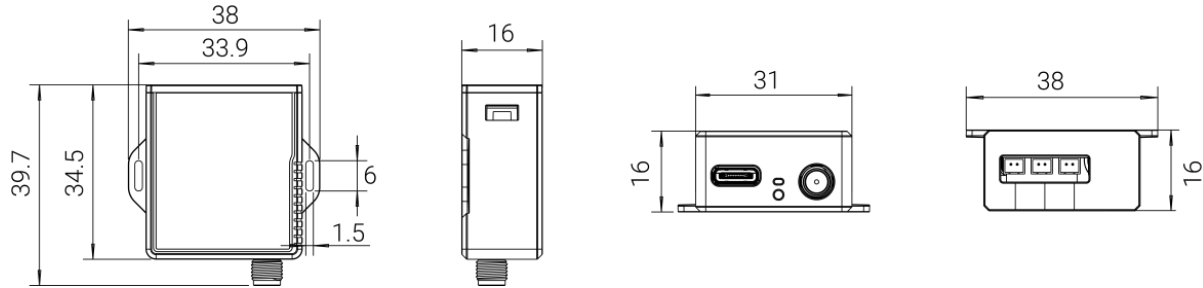

CT303:

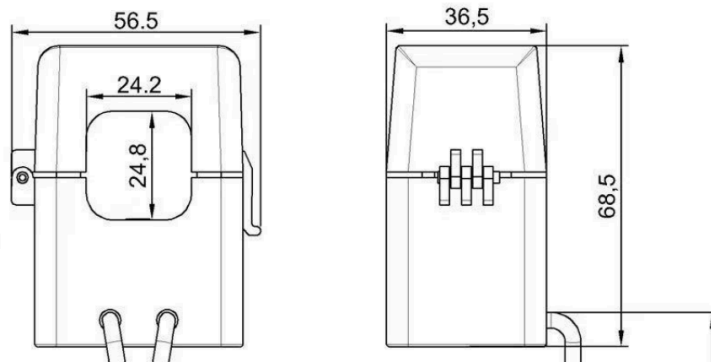

CT305:

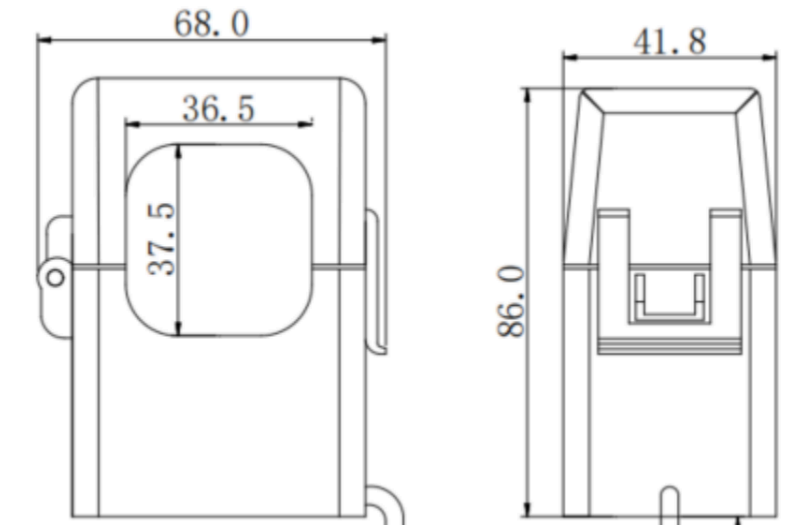

CT310:

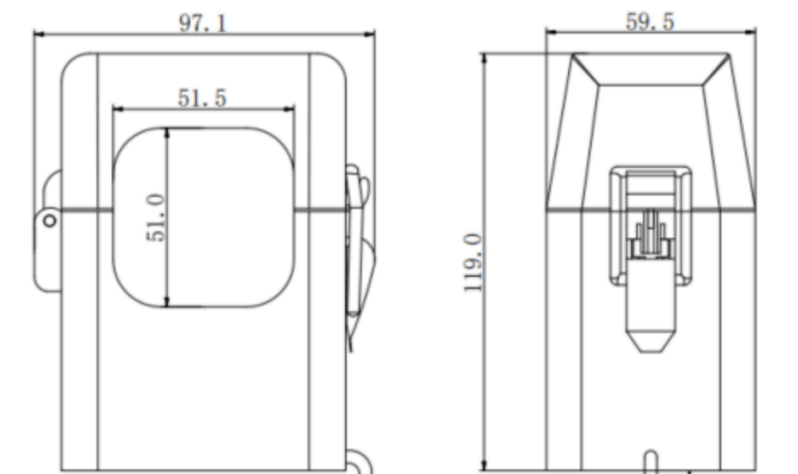

Chapter 4. Operation Guide

Access the Sensor

The device can be powered and configured via a Type-C port for configuration and console.

1. Download ToolBox software from [Milesight website](#).
2. Connect the device to a computer via the Type-C port.

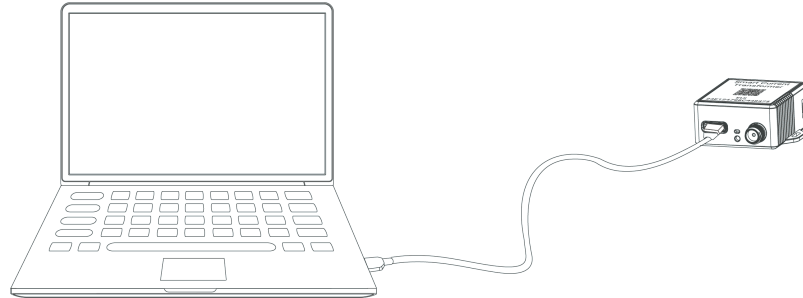

3. Open the ToolBox and select type as **General**, then click password to log into the ToolBox. (Default password: **123456**. In order to protect the security of the device, please change device password when first configuration.)

A screenshot of a software dialog box titled "ToolBox Settings". The dialog has a blue header bar with a close button (X) on the right. Below the header, there are several configuration options, each with a label and a dropdown menu or text input field. At the bottom, there are two blue buttons: "Save" and "Cancel".

Type	General
Serial port	COM4
Login password	
Baud rate	115200
Data bits	8
Parity bits	None
Stop bits	1

4. After logging into the ToolBox, you can check device status and change device settings.

Status >

Model:	CT305-470M
Serial Number:	6746D48074730024
Device EUI:	24e124746d480747
Firmware Version:	01.02-a1
Hardware Version:	1.1
Device Status:	On
Join Status:	Activate
RSSI/SNR:	0/0
Temperature:	6553.5°C
Current(Phase A):	0.00 A
Current(Phase B):	0.00 A
Current(Phase C):	0.00 A
Kiloampere Hour (Phase A Total):	2.35 Ah Clear
Kiloampere Hour (Phase B Total):	0.00 Ah Clear
Kiloampere Hour (Phase C Total):	0.00 Ah Clear
Channel Mask:	██
Uplink Frame-counter:	330

LoRaWAN[®] Settings

Basic Setting

Configure AppEUI, Join Type, Application Key, and other information. You can also keep all the default settings.

Device EUI	<input type="text" value="24E124756C221863"/>
App EUI	<input type="text" value="24E124C0002A0001"/>
Application Port	<input type="text" value="85"/>
Join Type	<input type="text" value="OTAA"/>
Application Key	<input type="text" value="*****"/>
RX2 Date Rate	<input type="text" value="DR8 (SF12, 500k)"/>
RX2 Frequency	<input type="text" value="923300000"/>

Spread Factor ? SF8-DR2



Confirmed Mode ?

Rejoin Mode ?

Set the number of packets sent packets

ADR Mode ?

TXPower

Parameters	Description
Device EUI	<p>Unique ID of the device which can be found on the device.</p> <p> Note: please contact sales for device EUI list if you have many units.</p>
App EUI	The default App EUI (join EUI) is 24E124C0002A0001.
Application Port	The port used for sending and receiving data, the default port is 85.
Join Type	<p>OTAA and ABP mode are available.</p> <p> Note: it's necessary to select OTAA mode if connecting device to Milesight IoT Cloud or Milesight Development Platform.</p>
Application Key	<p>Appkey for OTAA mode, default value: "Device EUI" + "Device EUI" (since Q4 of 2025). Example: 24e124123456789024e1241234567890</p> <p> Note:</p> <ul style="list-style-type: none"> • The default value of earlier devices is 5572404C696E6B4C6F52613230313823. • Please contact sales before purchase if you require random App Keys.
Network Session Key	Nwkskey for ABP mode, the default is 5572404C696E6B4C6F52613230313823.

Parameters	Description
Application Session Key	Appskey for ABP mode, the default is 5572404C696E6B4C6F52613230313823.
Device Address	DevAddr for ABP mode, default is the 5 th to 12 th digits of SN.
Confirmed Mode	If the device does not receive ACK packet from network server, it will resend data once.
Rejoin Mode	<p>Reporting interval ≤ 35 mins: the device will send a specific number of LinkCheck-Req MAC packets to the network server every reporting interval or every double reporting interval to validate connectivity; If there is no response, the device will re-join the network.</p> <p>Reporting interval > 35 mins: the device will send a specific number of LinkCheck-Req MAC packets to the network server every reporting interval to validate connectivity; If there is no response, the device will re-join the network.</p> <div style="background-color: #e6f2ff; padding: 10px; border: 1px solid #add8e6;"> <p> Note:</p> <ol style="list-style-type: none"> 1. Only OTAA mode supports rejoin mode. 2. The actual sending number is Set the number of packets sent + 1. </div>
ADR Mode	Enable or disable network server to adjust Spreading Factor, Bandwidth and Tx Power to optimize data rates, airtime and energy consumption in the network.
Spreading Factor	If ADR mode is disabled, the device will send uplink data following this SF parameter. The higher the spreading factor, the longer the transmission distance, the slower the transmission speed and the more the consumption.
Tx Power	Tx power (transmit power) refers to the strength of the outgoing signal transmitted by the device. This is defined by LoRa alliance.
RX2 Data Rate	RX2 data rate to receive downlinks.
RX2 Frequency	RX2 frequency to receive downlinks. Unit: Hz

LoRaWAN Frequency Settings

Go to **LoRaWAN Settings > Channel** to select supported frequency and select channels to send uplinks. Make sure the channels match what you set in the LoRaWAN[®] gateway.

Supported Frequency : AS923 Channel Plan AS923 1

<input type="checkbox"/>	Index	Frequency/MHz	Min Datarate	Max Datarate
<input checked="" type="checkbox"/>	0	923.2	5-SF7BW125	0-SF12BW125
<input checked="" type="checkbox"/>	1	923.4	5-SF7BW125	0-SF12BW125
<input type="checkbox"/>	2	0	5-SF7BW125	0-SF12BW125
<input type="checkbox"/>	3	0	5-SF7BW125	0-SF12BW125
<input type="checkbox"/>	4	0	5-SF7BW125	0-SF12BW125
<input type="checkbox"/>	5	0	5-SF7BW125	0-SF12BW125
<input type="checkbox"/>	6	0	0-SF12BW125	5-SF7BW125
<input type="checkbox"/>	7	0	0-SF12BW125	5-SF7BW125

Save

If frequency is one of CN470/AU915/US915, enter the index of the channel to enable in the input box, making them separated by commas.

Examples:

1, 40: Enabling Channel 1 and Channel 40

1-40: Enabling Channel 1 to Channel 40

1-40, 60: Enabling Channel 1 to Channel 40 and Channel 60

All: Enabling all channels

Null: Indicate that all channels are disabled

Supported Frequency : AU915

Enabled Channel Index: 0-71

Channel Index	Frequency/MHz	Channel Spacing/MHz	BW/kHz
0 - 15	915.2 - 918.2	0.2	125
16 - 31	918.4 - 921.4	0.2	125
32 - 47	921.6 - 924.6	0.2	125
48 - 63	924.8 - 927.8	0.2	125
64 - 71	915.9 - 927.1	1.6	500

Note:
64 channels numbered 0 to 63 utilizing LoRa 125 kHz BW starting at 915.2 MHz and incrementing linearly by 0.2 MHz to 927.8
8 channels numbered 64 to 71 utilizing LoRa 500 kHz BW starting at 915.9 MHz and incrementing linearly by 1.6 MHz to 927.1

Save

Basic & Alarm Settings

Basic Settings

Basic Settings

Device Type CT

Reporting Interval (min) 10

Change Password

Parameters	Description												
Reporting Interval	<p>The interval of reporting current data.</p> <p>Default: 10 mins, Range: 1 - 1440 mins</p> <div style="background-color: #e1f5fe; padding: 10px; border-radius: 5px; margin-top: 10px;"> <p> Note:</p> <p>1. It is necessary to meet the minimum reporting current requirement to report properly.</p> <table border="1" style="width: 100%; border-collapse: collapse; margin-top: 10px;"> <thead> <tr style="background-color: #0056b3; color: white;"> <th>Reporting Interval</th> <th>CT303</th> <th>CT305</th> <th>CT310</th> </tr> </thead> <tbody> <tr> <td style="text-align: center;">1 min</td> <td style="text-align: center;">25A</td> <td style="text-align: center;">30A</td> <td style="text-align: center;">60A</td> </tr> <tr> <td style="text-align: center;">10 min</td> <td style="text-align: center;">15A</td> <td style="text-align: center;">19A</td> <td style="text-align: center;">35A</td> </tr> </tbody> </table> </div>	Reporting Interval	CT303	CT305	CT310	1 min	25A	30A	60A	10 min	15A	19A	35A
Reporting Interval	CT303	CT305	CT310										
1 min	25A	30A	60A										
10 min	15A	19A	35A										

Parameters	Description
	 <p>To measure lower currents, the device must be powered via USB.</p> <ol style="list-style-type: none"> If the device does not meet the minimum reporting current requirement, it will enter either low-voltage mode or low-power mode. In low-power mode, the reporting interval is fixed at 30 minutes. In low-voltage mode, the device will stop reporting. The operating mode can be identified by the LED indicator. If the device meets the minimum reporting current requirement but still enters low-voltage or low-power mode, this indicates that the measured conductor is faulty or has no power. Please inspect and repair it promptly.
Change Password	Change the password of the device for ToolBox configuration.

Alarm Settings

Alarm Settings

Current Threshold(Phase A)

Excessive Current Threshold

Insufficient Current Threshold

Current Threshold(Phase B)

Current Threshold(Phase C)

Temperature

Over °C

Below °C

Alarm Reporting Interval(min)

Alarm Reporting Times

Parameters	Description
Alarm Reporting Interval (min)	The interval to report alarm packet after alarm triggers. This interval should be less than reporting interval.
Alarm Reporting Times	Alarm packet report times after alarm triggers.
Current Threshold (Phase x)	
Excessive Current Threshold	The maximum current threshold value.
Insufficient Current Threshold	The minimum current threshold value.
Temperature	
Over	The maximum temperature threshold value.
Below	The maximum temperature threshold value.

**Note:**

Current overrange alarm is fixed as enabled, the alarm reporting interval is fixed as 5 minutes and the alarm reporting time is fixed as 3.

Maintenance

Upgrade via ToolBox Software

1. Download firmware from Milesight official website to your computer.
2. Connect the device to computer via USB port, then log in to the device via ToolBox software.
3. Go to **Maintenance > Upgrade** page, click **Browse** to upload the firmware file and click **Upgrade** to upgrade the device.

Maintenance >

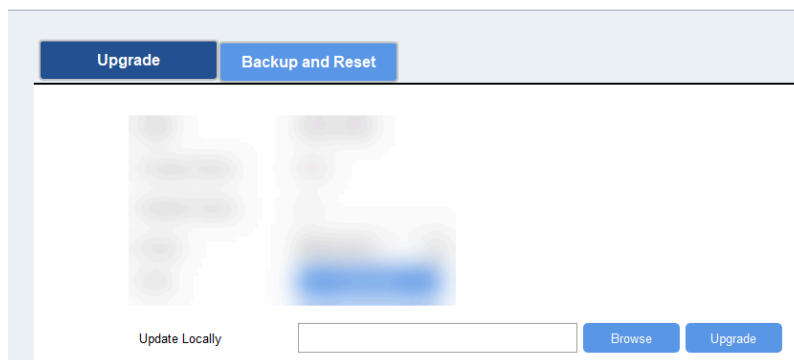

Backup and Restore via ToolBox Software

1. Connect the device to a computer via USB port, then log in to the device via ToolBox software.
2. Configure the device and save the settings.
3. Go to **Maintenance > Upgrade** page, click **Export** to save the template file to the computer.
4. Connect another target device to the same computer, go to **Maintenance > Upgrade** page to import the template file.

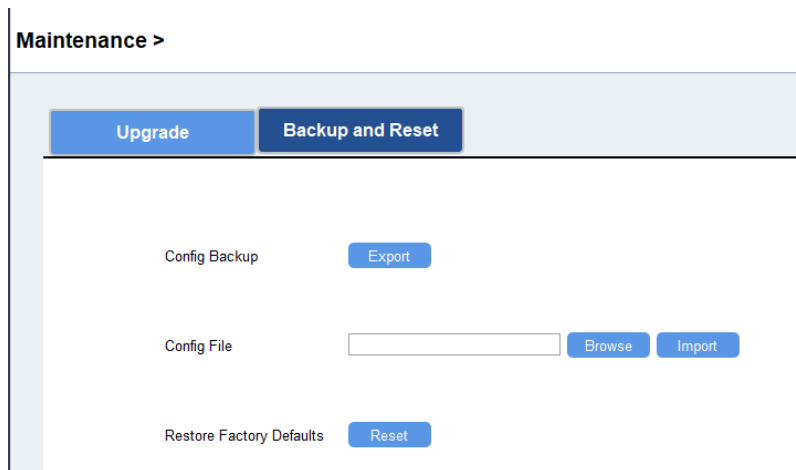

Reset to Factory Default

Go to **Maintenance > Backup and Reset** page, click **Reset** to reset the device.

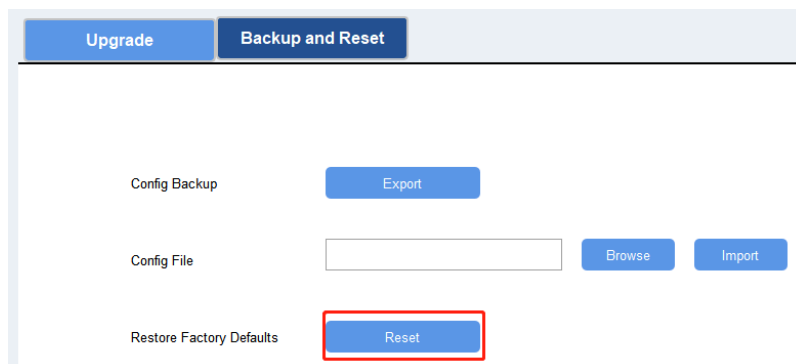

Reboot

Quick press the RST button once or send downlink command to reboot.

Chapter 5. Installation

Device Assembly

The CTs can be connected to the connectors of transceiver without any specific order matching requirement.

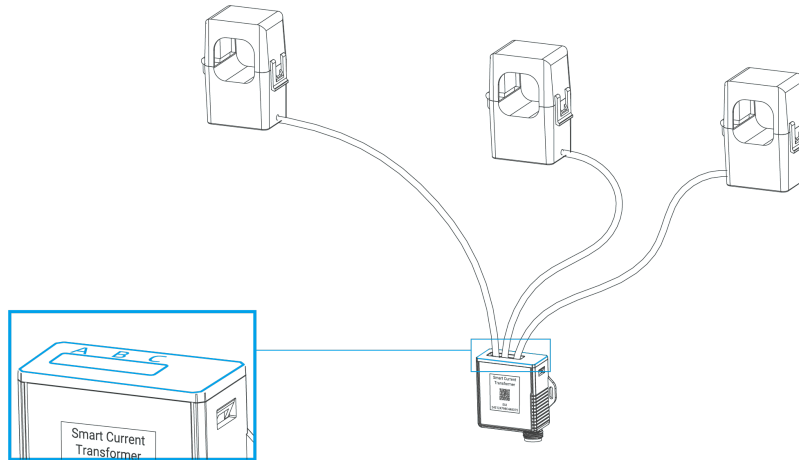

Antenna Installation

Rotate the antenna into the antenna connector. The antenna should be installed vertically and kept away from metal objects and obstacles.

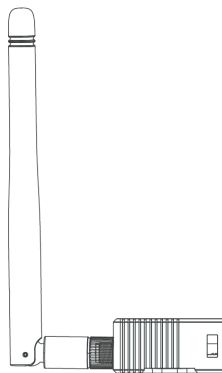

Note:

Keep the device away from metal objects, obstacles, or the environment surrounded by other electrical equipment that may cause interference. If necessary, please select a magnetic antenna.

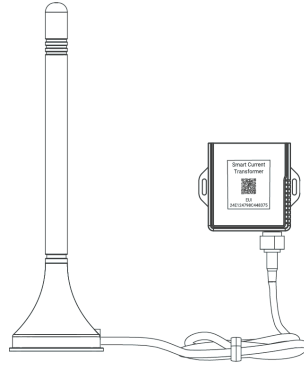

Transformer Installation

Open the current transformer to clip it around a single-phase wire. Then close the clip with a slight “click” sound to make sure the clip firmly grips the wire.

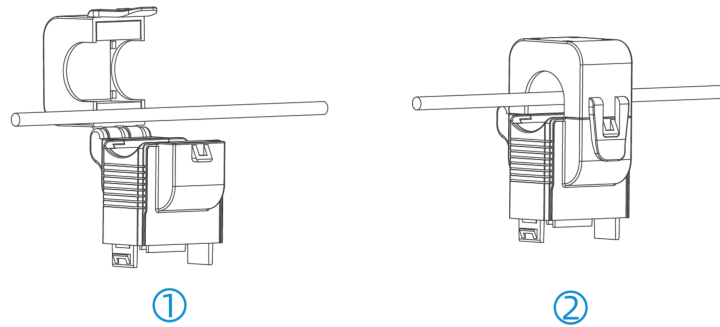

Note:

- Do not place Phase wire and Neutral wire within a single current transformer.

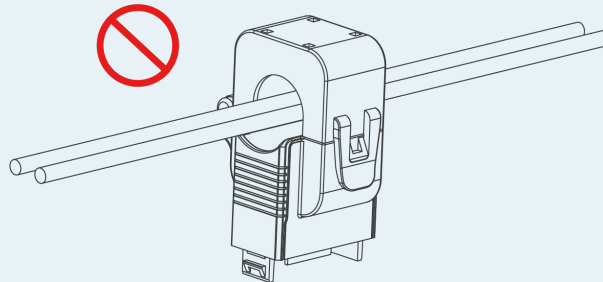



- Please make sure at least connect a phase A CT to phase A wire, otherwise the device will be powered off.

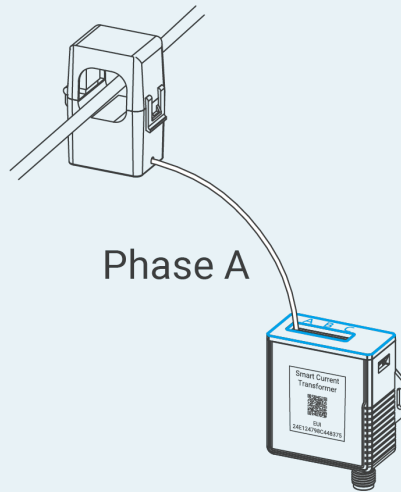

Transceiver Installation

The transceiver can be put or hang in any suitable position or to be fixed via cable-ties.



USB-C NTC Sensor Installation (Alternative)

The device can monitor the temperature of the wire through the USB-C NTC Sensor, it will alarm when the temperature exceeds the threshold.

Pass the USB-C NTC Sensor around the tested wire, and then tighten the buckle. The other end is connected to the CT device via the USB Type-C.

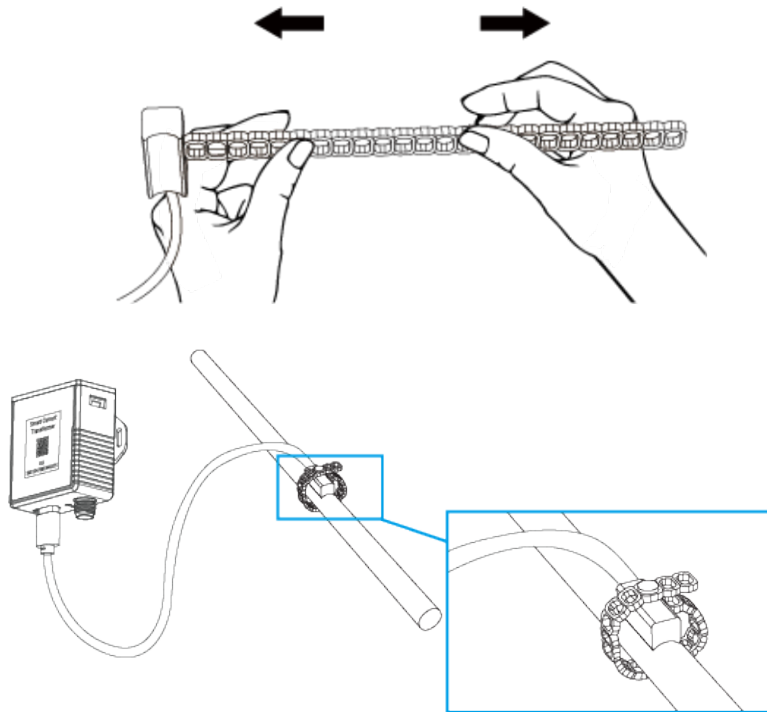

Note:

Keep the USB-C NTC Sensor as close to the wire connector as possible to better detect the temperature.

Chapter 6. Uplink and Downlink

Overview

All messages are based on following format (HEX), the Data field should follow little-endian:

Channel1	Type1	Data1	Channel2	Type2	Data2	Channel3	...
1 Byte	1 Byte	N Bytes	1 Byte	1 Byte	N Bytes	1 Byte	...

For decoder examples please find files on <https://github.com/Milesight-IoT/SensorDecoders>.

Uplink Data

Basic Information

The device will report a basic information packet whenever joining the network.

Item	Channel	Type	Byte	Description
Power On	ff	0b	1	Device is on
Protocol Version	ff	01	1	Example: 01=V1
Serial Number	ff	16	8	16 digits
Hardware Version	ff	09	2	Example: 03 10 = V3.1
Software Version	ff	0a	2	Example: 03 01 = V3.1
TSL Version	ff	ff	2	Example: 01 00=>V1.0
Device Type	ff	0f	1	00: Class A, 01: Class B, 02: Class C, 03: Class C to B



Example:

ff0bff ff0101 ffff0101 ff166746d48016300014 ff090110 ff0a0101 ff0f00		
Channel	Type	Value
ff	0b	Power On: ff(Reserved)
ff	01	Protocol Version: 01(V1)

ff0bff ff0101 ffff0101 ff166746d48016300014 ff090110 ff0a0101 ff0f00		
Channel	Type	Value
ff	ff	TSL Version: 0101(V1.1)
ff	16	Serial Number: 6746d48016300014
ff	09	Hardware Version: 0100 (V1.0)
ff	0a	Software Version: 0101(V1.1)
ff	0f	Device Type: 00(Class A)

Periodic Report

The device supports to report below types of periodic report packets.

Item	Channel	Type	Byte	Description
Phase A Total Current	03	97	4	UINT32/100, Unit: Ah, Resolution: 0.01 Ah  Note: when it reaches to max value FFFFFFFF (42949672.95), it will clear to 0 automatically.
Phase B Total Current	05			
Phase C Total Current	07			
Phase A Current	04	99	2	UINT16/10, Unit: A, Resolution: 0.1 A  Note: FFFF means collection failure.
Phase B Current	06			
Phase C Current	08			
Temperature	09	67	2	INT16/10, Unit: °C  Note: FFFD means overrange temperature; FFFF means collection failure.

Example:

Periodic packet: report as reporting interval (10 minutes by default).

039710270000 0499b80b 059710270000 0699b80b 079710270000 0899b80b 09673401		
Channel	Type	Value
03	97	Total Current: 73 02 00 00=>00 00 02 73=627/100=6.27 Ah
04	99	Phase A Current: b8 0b=>0b b8 =3000/10=300A
05	97	Phase B Total Current: 10 27 00 00=>00 00 27 10=10000/100=100 Ah
06	99	Phase B Current: b8 0b=>0b b8 =3000/10=300A
07	97	Phase C Total Current: 10 27 00 00=>00 00 27 10=10000/100=100 Ah
08	99	Phase C Current: b8 0b=>0b b8 =3000/10=300A
09	67	Temperature: 34 01=>01 34=308/10=30.8°C

Alarm Report

The device supports to report below types of alarm report packets.

Item	Channel	Type	Byte	Description
Phase A Current Alarm	84	99	7	Byte 1-2: Max. Current
Phase B Current Alarm	86			Byte 3-4: Min. Current
Phase C Current Alarm	88			Byte 5-6: Latest Current
		Byte 7: Alarm Status, 01: Threshold alarm 02: Threshold alarm dismiss 04: Overrange alarm 08: Overrange alarm dismiss 05: Threshold alarm + Overrange alarm		

Item	Channel	Type	Byte	Description
				0a: Threshold alarm dismiss + Over-range alarm dismiss  Note: Max./Min. Current means the maximum or minimum value between last report and current report.
Temperature Alarm	89	67	3	Byte 1-2: Temperature, INT16/10, Unit: °C Byte 3: 01-Threshold alarm; 00-Threshold alarm dismiss

Example:

Phase A current alarm or alarm dismiss packet:

8499 b80b d007 c409 01		
Channel	Type	Value
84	99	Max. Current: b8 0b=>0b b8=3000/100=30A Min. Current: d0 07=>07 d0=2000/100=20A Latest Current: c4 09=>09 c4=2500/100=25A Alarm Status: 01=>Threshold alarm

Downlink Command

The device supports downlink commands to configure the device. Application port is 85 by default.

General Setting

Item	Channel	Type	Byte	Description
Reboot	ff	10	1	ff
Clear Accumulated Current	ff	27	1	01: Phase A; 02: Phase B; 03: Phase C

Item	Channel	Type	Byte	Description
				 Note: when it reaches to max value FFFFFFFF (42949672.95Ah), it will clear to 0 automatically.
Reporting Interval	ff	8e	3	Byte 1: 00 Byte 2-3: UINT16, Unit: minute

Example:

1. Reboot the device.

ff10ff

2. Set report interval as 20 minutes.

ff8e001400		
Channel	Type	Value
ff	8e	1400=>0014=20minutes

Alarm Setting

Item	Channel	Type	Byte	Description
Threshold Alarm	ff	06	9	Byte 1: Bit0~Bit2: 000-disable 001-below (minimum threshold) 010-over (maximum threshold) 011-within 100-below or over Bit3~Bit5:

Item	Channel	Type	Byte	Description
				001-Phase A current 010-Phase B current 011-Phase C current 100-Temperature Bit6~Bit7: 00 Byte 2-3: Min. value, Unit: A or 0.1°C Byte 4-5: Max. value, Unit: A or 0.1°C Byte 6-9: 00000000
Alarm Re- porting Interval	ff	02	2	Unit: min, Range: 1~1440
Alarm Re- porting Times	ff	f2	2	Range: 1~1000

Example:

1. Enable Phase A current threshold alarm and set maximum threshold as 60A.

ff 06 0a00003c00 00000000		
Channel	Type	Value
ff	06	0a=00001010=>over Phase A current maximum threshold Min. value: 00 00=0 Max. value: 3c 00=> 00 3c=60 A

2. Set alarm reporting times as 10.

fff2 0a00		
Channel	Type	Value
ff	f2	0a 00=>00 0a=10

Chapter 7. Services

Milesight provides customers with timely and comprehensive technical support services. End-users can contact your local dealer to obtain technical support. Distributors and resellers can contact directly with Milesight for technical support.

Technical Support Mailbox: iot.support@milesight.com

Online Support Portal: <https://support.milesight-iot.com>

Resource Download Center: <https://www.milesight.com/iot/resources/download-center/>

MILESIGHT CHINA

TEL: +86-592-5085280

FAX: +86-592-5023065

Add: Building C09, Software Park Phase III, Xiamen 361024, Fujian, China