



Magnetic Contact Switch Sensor

EM300-MCS

User Guide

Contents

Chapter 1. Preface.....	4
Chapter 2. Product Introduction.....	6
Overview.....	6
Features.....	6
Chapter 3. Hardware Introduction.....	7
Packing List.....	7
Hardware Overview.....	7
Dimensions(mm).....	7
Power Button.....	8
Chapter 4. Quick Start.....	9
Chapter 5. Operation Guide.....	10
LoRaWAN Settings.....	10
General Setting.....	12
Time Synchronization.....	14
Calibration Setting.....	15
Temperature Threshold Setting.....	16
Magnet Switch Alarm.....	17
Milesight D2D Setting.....	17
Maintenance.....	19
Upgrade.....	19
Backup and Restore.....	20
Reset to Factory Default.....	22
Chapter 6. Installation.....	24
EM300 Device Installation.....	24
Magnet Installation.....	24
Chapter 7. Battery Replacing.....	26
Chapter 8. Uplink and Downlink.....	27

Overview.....	27
Uplink Data.....	27
Basic Information.....	28
Periodic Report.....	28
Alarm Report.....	29
Historical Data.....	29
Downlink Command.....	30
General Setting.....	30
Calibration Setting.....	31
Temperature Threshold Setting.....	31
Alarm Setting.....	32
D2D Setting.....	32
Historical Data Enquiry.....	33
Chapter 9. Services.....	36

Chapter 1. Preface

Copyright Statement

This guide may not be reproduced in any form or by any means to create any derivative such as translation, transformation, or adaptation without the prior written permission of Xiamen Milesight IoT Co., Ltd (Hereinafter referred to as Milesight).

Milesight reserves the right to change this guide and the specifications without prior notice. The latest specifications and user documentation for all Milesight products are available on our official website <http://www.milesight.com>

Safety Instruction

These instructions are intended to ensure that user can use the product correctly to avoid danger or property loss. Milesight will not shoulder responsibility for any loss or damage resulting from not following the instructions of this operating guide.

**CAUTION:**

Injury or equipment damage may be caused if any of these cautions are neglected.

- The device is not intended to be used as a reference sensor, and Milesight will not shoulder responsibility for any damage which may result from inaccurate readings.
- The device must not be disassembled or remodeled in any way.
- Do not place the device close to objects with naked flames.
- Do not place the device where the temperature is below/above the operating range.
- Make sure electronic components do not drop out of the enclosure while opening.
- When installing the battery, please install it accurately, and do not install the reverse or wrong model.
- The device must never be subjected to shocks or impacts.
- In order to protect the security of the device, please change device password when first configuration. The default password is 123456.

Revision History

Release Date	Version	Revision Content
July 5, 2021	V2.0	Update based on hardware 3.x: delete USB port
December 7, 2021	V2.1	Add alarm setting, change SN to 16 digits
November 24, 2022	V2.2	<ol style="list-style-type: none">1. Add Milesight D2D feature2. Add data storage, data retransmission and data retrievability feature3. Add time synchronization feature
December 26, 2024	V2.3	Add calibration downlink commands

Chapter 2. Product Introduction

Overview

EM300-MCS is a compact magnet switch sensor for detecting open/close status of objects (such as doors or windows) and transmitting alarm using LoRaWAN[®] technology. With this low power consumption technology, EM300-MCS can work up to 5 years with 4000 mAh battery. Combining with Milesight LoRaWAN[®] gateway and Milesight Development Platform solution, users can manage all sensor data and remotely and visually and receive alarms.

EM300-MCS also integrates temperature and humidity sensors, which has a great use for applications such as home and office automation, factories monitoring, etc.

Features

- High sensitivity with door and window security detection
- Embedded with temperature and humidity sensors for environment monitoring
- Ultra-wide-distance transmission up to line of sight of 10km
- IP67 UV-resistant and waterproof enclosure for harsh environment applications
- Built-in 4000 mAh replaceable battery and works for more than 5 years without replacement
- Store locally 2, 800 historical records and support retransmission to prevent data loss
- Support Milesight D2D protocol to enable ultra-low latency and direct control without gateways
- Equipped with NFC for easily configuration
- Compliant with standard LoRaWAN[®] gateways and network servers
- Quick and easy management with Milesight IoT Cloud or Milesight Development Platform

Chapter 3. Hardware Introduction

Packing List



1 × EM300-MCS Device

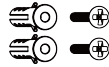

2 × Wall Mounting Kits



2 × Screw Caps



1 × Quick Guide



1 × Warranty Card



2 × 3M Double Sided Tapes

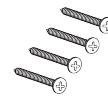

4 × Mounting Screws



Note:

If any of the above items is missing or damaged, please contact your sales representative.

Hardware Overview

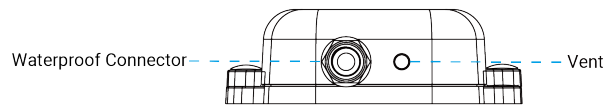
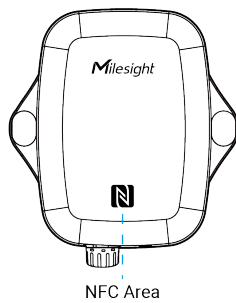

Dimensions(mm)

Transceiver:

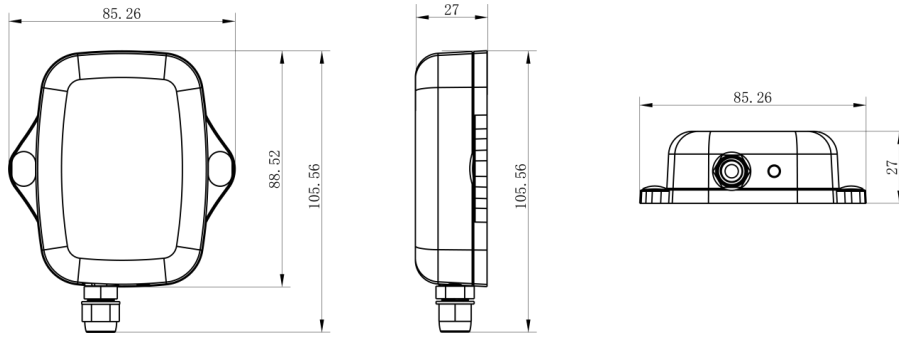

Magnet:

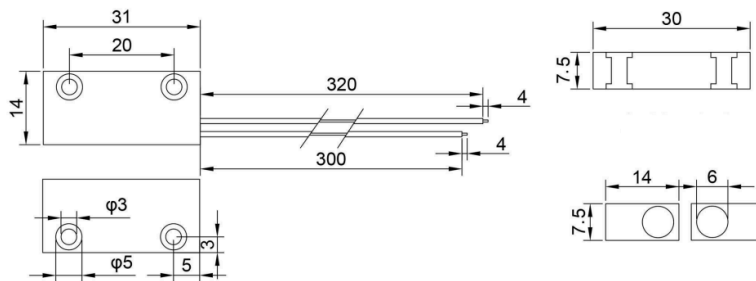

Power Button

There is a LED indicator and a power button inside the device for emergency reboot or reset.

Function	Action	LED Indicator
Power On	Press and hold the button for more than 3 seconds.	Off → On
Power Off		On → Off
Reset to Factory Default	Press and hold the button for more than 10 seconds.	Blinks quickly
Check On/Off Status	Quickly press the power button once.	Light On: device is on.
		Light Off: device is off.

Chapter 4. Quick Start

This chapter describe the steps to quickly configure this device. If you requires more advanced settings, please refer to operation guide chapter.

1. Download and install “Milesight ToolBox” App from Google Play or Apple Store on an NFC-supported smartphone.
2. Enable NFC function on the smartphone, launch Milesight ToolBox, and select the default mode as NFC.
3. Attach the smart phone with NFC area to the device and click  to read device information.

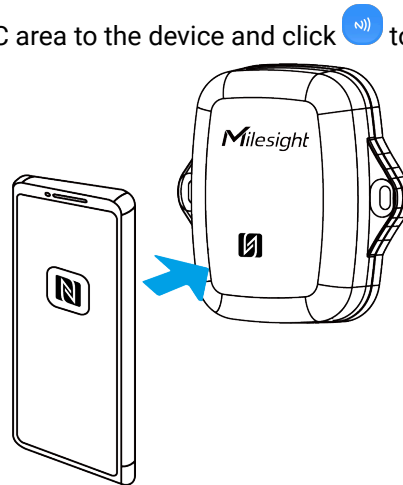

4. Click power button on the ToolBox App and attach the smartphone to device to power on the device.
5. Keep other settings by default or change as required, then attach the smartphone with NFC area to the device and click **Write** to write the settings. After writing, reread the device to check if the configuration is written well.





Note:



Set the channel index as 8-15 for US915 or AU915 if using default settings of Milesight gateways.

Chapter 5. Operation Guide

LoRaWAN Settings

This chapter describes the LoRaWAN[®] network settings of device.

Parameter	Description
Device EUI	<p>Unique ID of the device which can be found on the device.</p> <div style="border: 1px solid #ccc; background-color: #e6f2ff; padding: 10px; margin-top: 10px;">  Note: please contact sales for device EUI list if you have many units. </div>
App EUI	The default App EUI (join EUI) is 24E124C0002A0001.
Application Port	The port used for sending and receiving data, the default port is 85.
LoRaWAN [®] Version	V1.0.2 and V1.0.3 are available.
Work Mode	It's fixed as Class A.
Confirmed Mode	If the device does not receive ACK packet from network server, it will resend data once.
Join Type	<p>OTAA and ABP mode are available.</p> <div style="border: 1px solid #ccc; background-color: #e6f2ff; padding: 10px; margin-top: 10px;">  Note: it's necessary to select OTAA mode if connecting device to Milesight IoT Cloud or Milesight Development Platform. </div>
Application Key	Appkey for OTAA mode, default value: "Device EUI" + "Device EUI" (since Q4 of 2025). Example: 24e124123456789024e1241234567890

Parameter	Description
	<div style="background-color: #e6f2ff; padding: 10px; border-radius: 5px;">  Note: <ul style="list-style-type: none"> The default value of earlier devices is 5572404C696E6B4C6F52613230313823. Please contact sales before purchase if you require random App Keys. </div>
Network Session Key	Nwkskey for ABP mode, the default is 5572404C696E6B4C6F52613230313823.
Application Session Key	Appskey for ABP mode, the default is 5572404C696E6B4C6F52613230313823.
Device Address	DevAddr for ABP mode, default is the 5 th to 12 th digits of SN.
Rejoin Mode	<p>Reporting interval ≤ 35 mins: the device will send a specific number of Link-CheckReq MAC packets to the network server every reporting interval or every double reporting interval to validate connectivity; If there is no response, the device will re-join the network.</p> <p>Reporting interval > 35 mins: the device will send a specific number of Link-CheckReq MAC packets to the network server every reporting interval to validate connectivity; If there is no response, the device will re-join the network.</p> <div style="background-color: #e6f2ff; padding: 10px; border-radius: 5px;">  Note: <ol style="list-style-type: none"> 1. Only OTAA mode supports rejoin mode. 2. The actual sending number is Set the number of packets sent +1. </div>
Supported Frequency	<p>Enable or disable the frequency to send uplinks. If frequency is one of CN470/AU915/US915, enter the index of the channel to enable in the input box, making them separated by commas.</p> <p>Examples:</p>

Parameter	Description
	<p>1, 40: Enabling Channel 1 and Channel 40</p> <p>1-40: Enabling Channel 1 to Channel 40</p> <p>1-40, 60: Enabling Channel 1 to Channel 40 and Channel 60</p> <p>All: Enabling all channels</p> <p>Null: Indicate that all channels are disabled</p>
ADR Mode	Enable or disable network server to adjust Spreading Factor, Bandwidth and Tx Power to optimize data rates, airtime and energy consumption in the network.
Spreading Factor	If ADR mode is disabled, the device will send uplink data following this SF parameter. The higher the spreading factor, the longer the transmission distance, the slower the transmission speed and the more the consumption.
Tx Power	Tx power (transmit power) refers to the strength of the outgoing signal transmitted by the device. This is defined by LoRa alliance.
RX2 Data Rate	RX2 data rate to receive downlinks.
RX2 Frequency	RX2 frequency to receive downlinks. Unit: Hz

General Setting

General settings include the basic parameters of the device.

Parameter	Description
Temperature Unit	<p>Change the temperature displayed on the ToolBox.</p> <div style="background-color: #e6f2ff; padding: 10px; border-radius: 5px;"> <p> Note:</p> <ol style="list-style-type: none"> 1. The temperature unit in the reporting package is fixed as Celsius(°C). 2. Please modify the threshold settings if the unit is changed. </div>

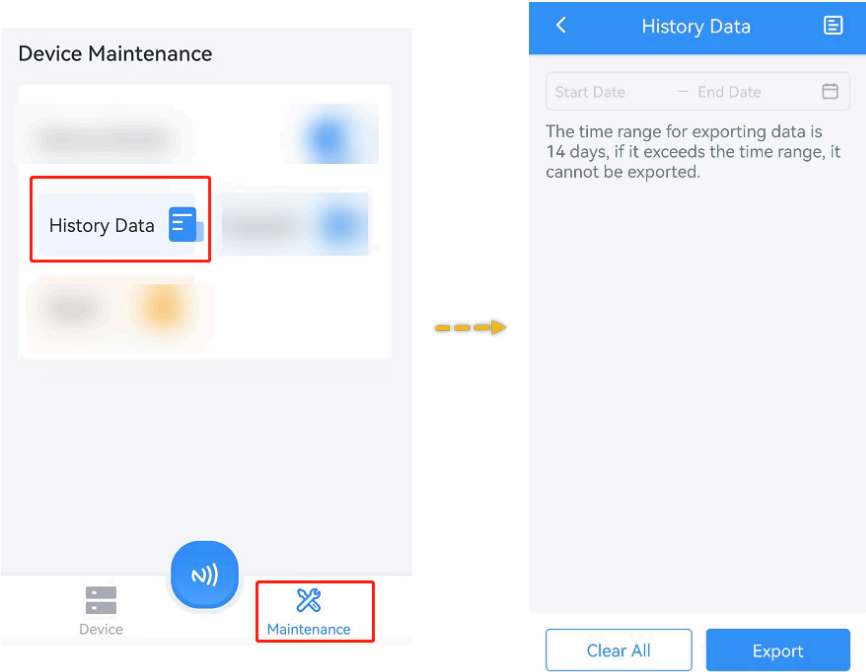
Parameter	Description
Reporting Interval	The interval to report current data to network server. Range: 1-1080 minutes, Default: 10 minutes.
Data Storage	<p>Disable or enable to store periodic report data locally. The stored data can be exported as CSV format file and saved to smartphone via ToolBox.</p>  <p>Note:</p> <ol style="list-style-type: none"> 1. It is necessary to sync the time to ensure the data is stored in correct time. 2. The device will still store the data even the network status is de-activated. 3. ToolBox App can only export the last 14 days' data at most.
Data Retransmission	Disable or enable data retransmission. When the device detects the network status is de-activated via Rejoin Mode , the device will record a data lost time point and re-transmit the lost data after device re-connects to the network.

Parameter	Description
	<p> Note:</p> <ol style="list-style-type: none"> 1. This setting only takes effect when Data Storage is enabled. 2. If the device is rebooted or re-power when data retransmission is not completed, the device will re-send all retransmission data again after device is reconnected to the network. 3. If the network is disconnected again during data retransmission, it will only send the latest disconnected data. 4. The default report data retransmission interval is 600s, this can be changed via downlink command. 5. The reported format of retransmission data will include timestamps and is different from periodic report data. 6. This setting will increase the uplink frequencies and shorten the battery life.
Change Password	Change the device password for ToolBox App to write this device.

Time Synchronization

This section describes how to sync the time of the device.

Sync via ToolBox App

After reading the device via Milesight ToolBox App, sync the device time with time zone from the smart phone.

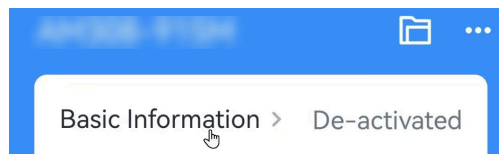

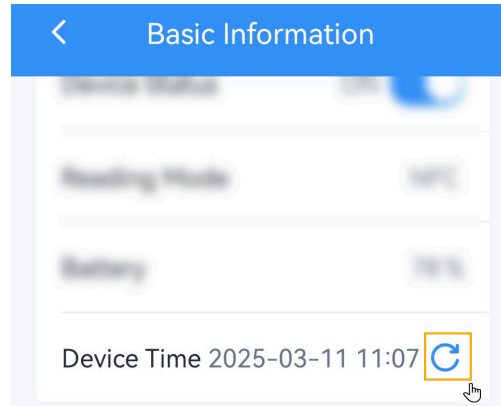

Sync via Network Server

This requires to ensure the LoRaWAN[®] network server supports device time synchronization feature. Example: Milesight gateway embedded NS.

1. Set the LoRaWAN[®] version of the device to V1.0.3.
2. Connect the device to the network server. After joining the network, the device will send a DeviceTimeReq MAC command to enquire the time from network server.



Note:

- This only supports to get the time but not time zone. The time zone can be configured by ToolBox App or downlink command.
- The device will send the DeviceTimeReq command every 5 days since the last sync.

Calibration Setting

The device supports to add the calibration value to the raw collected value, and report the results.

Temperature 

Numerical Calibration

Current Value: 27.3 °C

Calibration Value

°C

Final Value: 27.2 °C

Humidity 

Temperature Threshold Setting

When current value is over or below the threshold value, the device will report a threshold alarm packet once instantly. Only when the threshold alarm is dismissed and re-triggered, the device will send the threshold alarm again.

Parameter	Description
Collect Interval	The interval to detect temperature after threshold alarm triggers. This interval should be less than reporting interval.



Device Network

Calibration [Threshold](#) Alarm 

Temperature 

Over / °C

Below / °C

Collecting Interval  1  min

Magnet Switch Alarm

The device will report the alarm packets according to the alarm reporting interval and alarm reporting times when it detects the magnet status change. Only when the alarm is dismissed and re-triggered, the device will send the alarm again.

Parameter	Description
Alarm Reporting Interval	The interval to report alarm packet after alarm triggers.
Alarm Reporting Times	Alarm packet report times after alarm triggers.

Alarm Settings



Alarm Reporting



If someone invades, the alarm reporting interval and the alarm reporting times can be set as follows

Alarm Reporting Interval 1 min

Alarm Reporting Times 2

Milesight D2D Setting

Milesight D2D protocol is developed by Milesight and used for setting up transmission among Milesight devices without gateway. When the Milesight D2D settings is enabled, the device can work as a D2D controller to send control commands to trigger Milesight D2D agent devices.

1. Configure the RX2 datarate and RX2 frequency.



Note:

It is suggested to change the default values if there are many LoRaWAN[®] devices around.

Device
Network

LoRaWAN D2D

Spreading Factor ⓘ

SF12-DR0
▼

TXPower

TXPower0-16 dBm
▼

RX2 Data Rate ⓘ

DR0 (SF12, 125 kHz)
▼

RX2 Frequency ⓘ

869525000

2. Enable and configure the threshold alarm settings.

3. Enable Milesight D2D feature and define a unique D2D key that is the same as Milesight D2D agent devices. (Default D2D key: 5572404C696E6B4C6F52613230313823)

Device
Network

LoRaWAN D2D

Enable

D2D Key

4. Enable one of statuses and configure 2-byte hexadecimal Milesight D2D command.

**Note:**

If you enable **LoRa Uplink**, a LoRaWAN[®] uplink packet that contains corresponding alarm status will be sent to gateway after the Milesight D2D command packet. Otherwise, the alarm packet will not send to LoRaWAN[®] gateway.

Example: When the temperature reaches the threshold, the device will send command 0001 to D2D agent devices.

Temperature Threshold Triggered

Control command

LoRa Uplink ⓘ

Maintenance

Upgrade

This chapter describes the steps to upgrade the device via ToolBox App.

1. Download firmware from Milesight official website to your smartphone.
2. Read the target device via ToolBox App, click **Upgrade** to upload the firmware file.
3. Click **Upgrade** to upgrade the device.

**Note:**

- Operation on ToolBox is not supported during an upgrade.
- Only Android version ToolBox supports the upgrade feature.

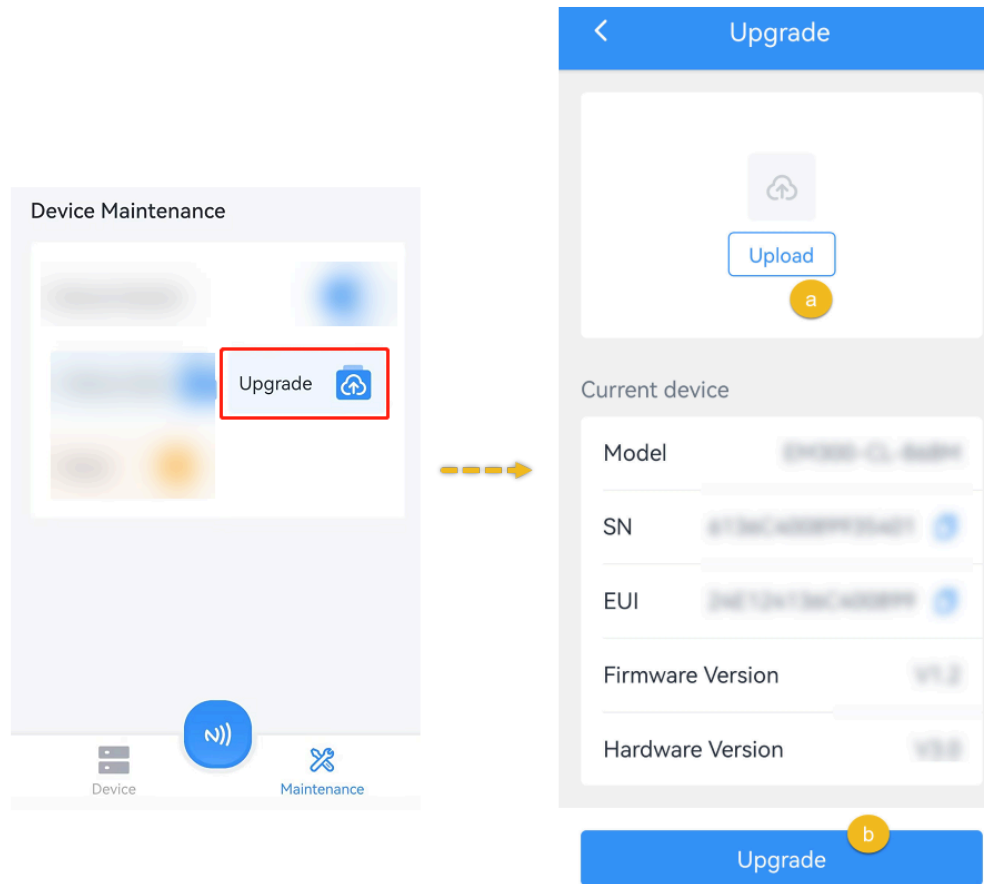

Backup and Restore

This device supports configuration backup for easy and quick device configuration in bulks. Backup and restore is allowed only for devices with the same model and frequency band.

Backup and Restore

1. Launch ToolBox App, attach the NFC area of smartphone to the device to read the configuration.
2. Edit the configuration as required, click **Set Template** to save current configuration as a template to the ToolBox App.

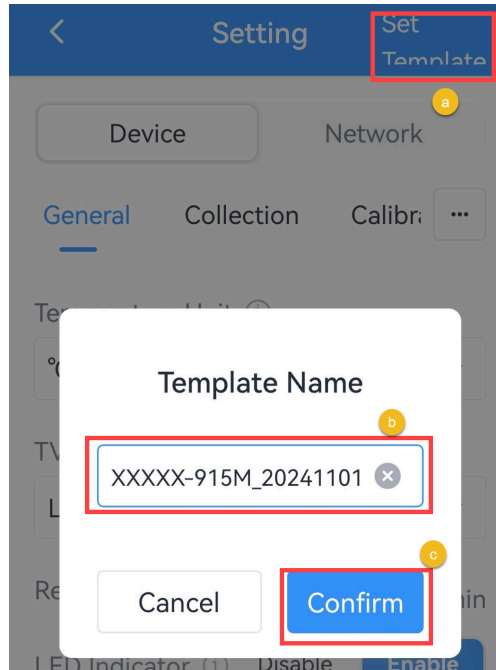

3. Go to **Device >Template** page.



4. Select and click the target template, click **Write** to import the configuration to target devices.

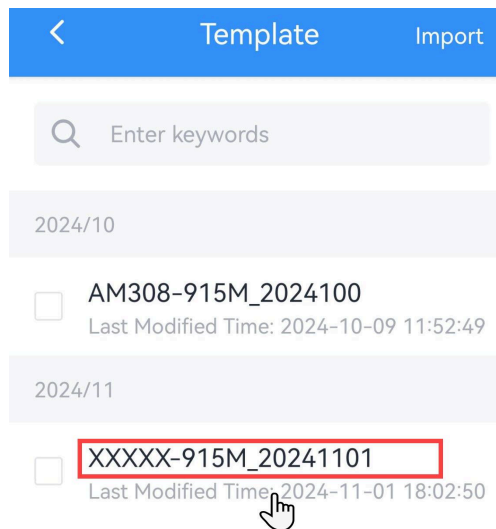

Export and Delete Template

1. Check the box of the target template.
2. Click **Export** to export this template as JSON format file and save it to the smartphone, click **Delete** to delete this template from your Toolbox App.

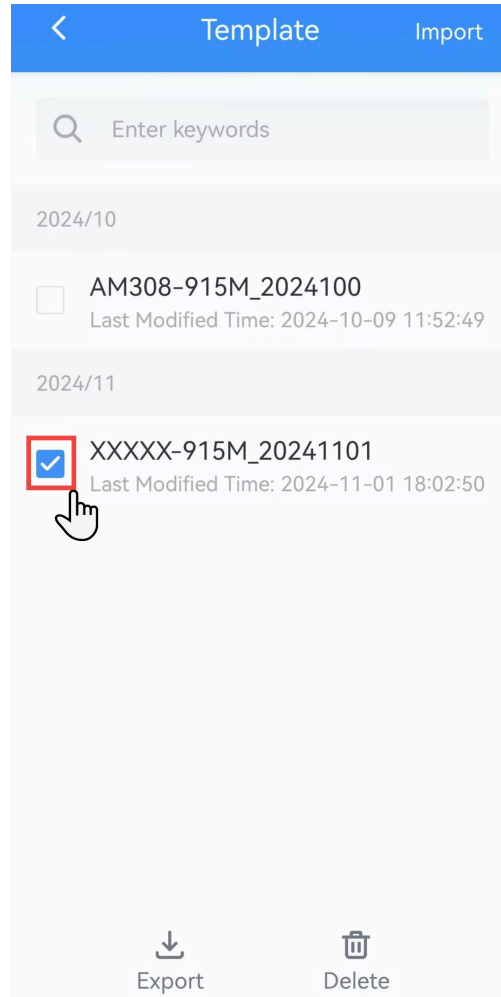

Reset to Factory Default

Via Hardware: Hold on the reset button for more than 10s until the LED indicator quickly blinks.

Via Toolbox App: Click **Reset** and attach the smartphone to device to reset the device.

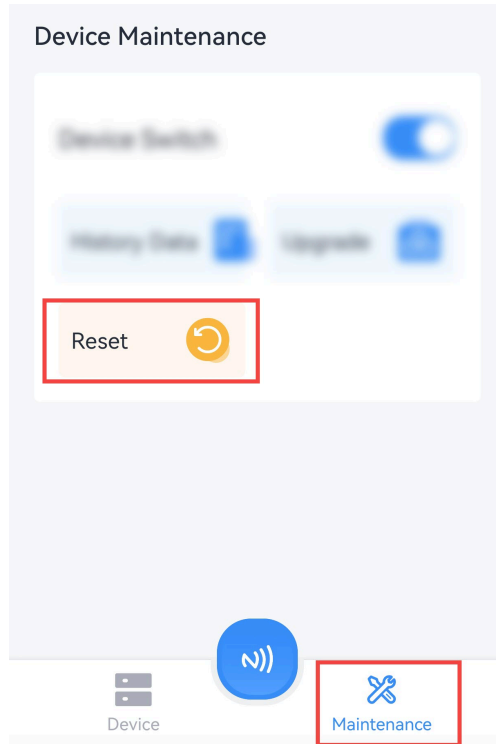

Chapter 6. Installation

EM300 Device Installation

Installation Location

Keep the device away from metal objects and obstacles.

Wall Mounting

Step 1: Attach EM300 device to the wall and mark the two holes on the wall. The connecting line of two holes must be a horizontal line.

Step 2: Drill the holes according to the marks and screw the wall plugs into the wall.

Step 3: Mount the EM300 to the wall via mounting screws.

Step 4: Cover the mounting screws with screw caps.

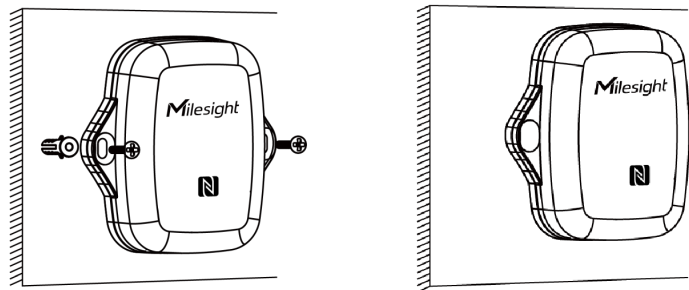

Besides, it can also be mounted to the wall via a 3M tape.

Pole Mounting

Pass the cable tie through the mounting holes of the device and wrap the device to the pole.

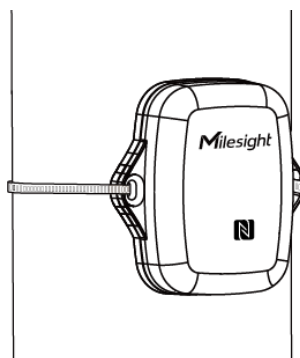

Magnet Installation

Installation Locations

- Doors, windows and any facilities to detect open/close status.
- Do not install the magnets to or close to iron objects.

Installation Steps

1. Put the two magnet parts to target location and mark the location as needed. To ensure the best detection, both parts should be aligned and the holes of magnets should be faced outside.

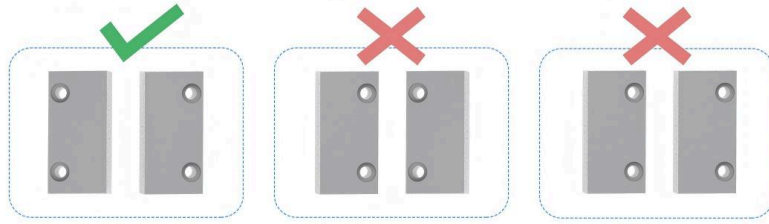

2. Fix the two magnet parts with 3M tape or screws.

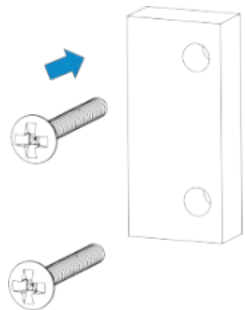

Fixed by Screws

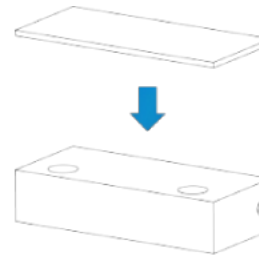

Fixed by 3M Tapes

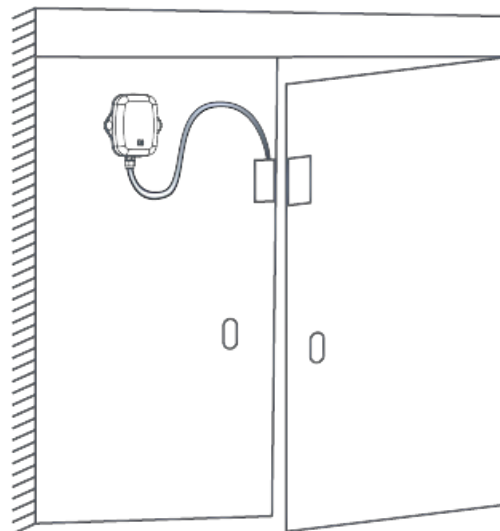

Chapter 7. Battery Replacing

When the batteries have run out of power, please remove the back cover to replace the new batteries.

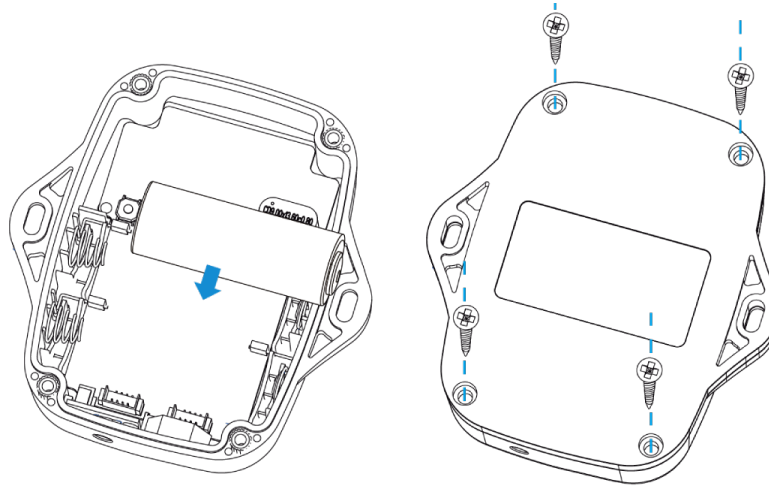

Note:

- EM300 provides 4000mAh version and 8000mAh version. Please do not install 2 batteries on the 4000mAh version, and vice versa. Otherwise, it will cause inaccurate power calculations.
- To reduce the interference of NFC transmission, it is suggested that the battery be installed in the upper location (see figure).
- The device can only be powered by the ER18505 Li-SoCl₂ battery. The alkaline battery is not supported.
- The battery should be removed or replaced from the device if it is not used for an extended period.
- Ensure all replacing batteries are newest; otherwise, it may shorten battery life or cause inaccurate power calculations.

Chapter 8. Uplink and Downlink

Overview

All messages are based on following format (HEX), the Data field should follow little-endian:

Channel1	Type1	Data1	Channel2	Type2	Data2	Channel3	...
1 Byte	1 Byte	N Bytes	1 Byte	1 Byte	N Bytes	1 Byte	...

For decoder examples please find files on <https://github.com/Milesight-IoT/SensorDecoders>.

Uplink Data

This chapter describes the reported data of the device.

Item	Channel	Type	Byte	Description
Power On	ff	0b	1	Device is on
Protocol Version	ff	01	1	Example: 01=V1
Hardware Version	ff	09	2	Example: 03 10 = V3.1
Software Version	ff	0a	2	Example: 03 01 = V3.1
Device Type	ff	0f	1	00: Class A, 01: Class B, 02: Class C, 03: Class C to B
Serial Number	ff	16	8	16 digits
Battery Level	01	75	1	UINT8, Unit: %
Temperature	03	67	2	INT16/10, Unit: °C
Humidity	04	68	1	UINT8/2, Unit: %RH
Magnet Status	06	00	1	00: Close, 01: Open (Separate)
Historical Data	20	ce	8	Byte 1-4: Data unix timestamp, UINT32, Unit: s Byte 5-6: Temperature, INT16/10, Unit: °C Byte 7: Humidity, UINT8/2, Unit: %RH Byte 8: 00=close, 01=open

Basic Information

The device will report a basic information packet whenever joining the network.

Example:

ff0bff ff0101 ff166136c40091605408 ff090300 ff0a0101 ff0f00		
Channel	Type	Value
ff	0b	ff
ff	01	01=V1
ff	16	6136c40091605408
ff	09	0300=V3.0
ff	0a	0101=V1.1
ff	0f	00: Class A

Periodic Report

The device supports to report below types of periodic report packets.

1. Sensor data: report according to reporting interval.

03671001046871060000		
Channel	Type	Value
03	67	Temperature: 1001=> 0110 = 272/10=27.2°C
04	68	Humidity: 71 => 113/2=56.5 %RH
06	00	00: close

2. Battery level: report when the device joins the network or every 6 hours.

017564		
Channel	Type	Value
01	75	Battery: 64=>100%

Alarm Report

The device supports to report below types of alarm report packets.

1. Temperature threshold alarm: report when threshold alarm is enabled.

03671001		
Channel	Type	Value
03	67	Temperature: 1001=> 0110 = 272/10=27.2°C

2. Magnet alarm or alarm dismiss: report when alarm reporting feature is enabled.

060001		
Channel	Type	Value
06	00	01: Open

3. Low battery level alarm: report when the battery level drops to 1%.

017501		
Channel	Type	Value
01	75	01=1%

Historical Data

The device will report retransmission data or stored data as below example.

20ce 0d755b63 0801 57 00			
Channel	Type	Time Stamp	Value
20	ce	0d 75 5b 63 => 63 5b 75 0d=1666938125s	Temperature: 0801=>0108=264/10=26.4 °C Humidity: 57=>87/2=43.5%RH Magnet status: 00=close

Downlink Command

This device supports downlink commands for configuration and control. The downlink application port is 85 by default.

General Setting

Item	Channel	Type	Byte	Description
Reboot	ff	10	1	ff
Collect Interval	ff	02	2	UINT16, Unit: s
Report Interval	ff	03	2	UINT16, Unit: s
Data Storage	ff	68	1	00: Disable, 01: Enable
Data Retransmission	ff	69	1	00: Disable, 01: Enable
Data Retransmission Interval	ff	6a	3	Byte 1: 00 Byte 2-3: UINT16, Unit: s, Range: 30~1200, Default: 600

Example:

1. Reboot the device.

ff10ff

2. Set collect interval as 20 minutes.

ff02b004		
Channel	Type	Value
ff	02	b004=>04b0=1200s=20 minutes

3. Set report interval as 20 minutes.

ff03b004		
Channel	Type	Value
ff	03	b004=>04b0=1200s=20 minutes

Calibration Setting

Channel	Type	Byte	Description
ff	ea	3	<p>Byte 1: 00=Temperature disable, 80=Temperature enable, 01=Humidity disable, 81=Humidity enable</p> <p>Byte 2-3: Calibration value, temperature= INT16/10, humidity=INT16/2</p>

Example:

Enable temperature calibration and set calibration value as -0.3°C.

ffab80fdff		
Channel	Type	Value
ff	ea	<p>80=Temperature calibration enable</p> <p>Calibration value: fd ff=> ff fd=-3/10=-0.3°C</p>

Temperature Threshold Setting

Channel	Type	Byte	Description
ff	06	9	<p>Byte 1: 08=Disable, 09=Below (min. threshold), 0a=Over (max. threshold), 0b=Within, 0c=Below or over</p> <p>Byte 2-3: Minimum threshold, INT16/10, Unit: °C</p> <p>Byte 4-5: Maximum threshold, INT16/10, Unit: °C</p> <p>Byte 6-9: 00000000</p>

Example:

Set a temperature threshold as below 15°C or over 30°C.

ff060c96002c0100000000		
Channel	Type	Value
ff	06	<p>0c=Below or over</p> <p>Min. threshold: 96 00=>00 96=150/10=15°C</p>

ff06c96002c010000000		
Channel	Type	Value
		Max. threshold: 2c 01 => 01 2c =300/10=30°C

Alarm Setting

Channel	Type	Byte	Description
ff	06	9	<p>Byte 1: 10=Disable, 11=Enable</p> <p>Byte 2-5: 00000000</p> <p>Byte 6-7: Alarm reporting interval, unit: s</p> <p>Byte 8-9: Alarm reporting times</p>

Example:

Enable alarm and set alarm reporting interval as 1 minute and alarm reporting times as 2.

ff0611000000003c000200		
Channel	Type	Value
ff	06	<p>11=Enable</p> <p>3c00=>003c=60s=1 minute</p> <p>0200=>0002=2</p>

D2D Setting

Channel	Type	Byte	Description
ff	79	4	<p>Byte 1:</p> <p>01=Temperature Threshold Triggered, 02=Temperature Threshold Released</p> <p>03=Open, 04=Close</p> <p>Byte 2: 00=Disable, 01=Only D2D, 03=D2D & LoRa Uplink</p> <p>Byte 3-4: D2D Command</p>

Example:

When temperature reaches the threshold, send D2D command 0110.

ff7901011001		
Channel	Type	Value
ff	79	01=Temperature Threshold Triggered 01=Only D2D D2D Command: 10 01=>0110

Historical Data Enquiry

The device supports data retrievability feature to send downlink command to enquire the historical data stored in the device. Before that, ensure the device time is correct and data storage feature was enabled to store data.

Command Format:

Item	Channel	Type	Byte	Description
Enquire Data in Time Point	fd	6b	4	Unix timestamp, Unit: s
Enquire Data in Time Range	fd	6c	8	Byte 1-4: Start timestamp, Unit: s Byte 5-8: End timestamp, Unit: s
Stop Query Data Report	fd	6d	1	ff
Data Retrieval Interval	ff	6a	3	Byte 1: 01 Byte 2-3: UINT16, Unit: s, Range: 30~1200, Default: 60

Reply Format:

Item	Channel	Type	Byte	Description
Enquiry Result	fc	6b/6c	1	00: Enquiry success. The device will report the historical data according to data retrievability interval. 01: Time point or time range invalid 02: No data in this time or time range

**Note:**

1. Use [Unix Timestamp Converter](#) to calculate the time.
2. The device only uploads no more than 300 data records per range enquiry.
3. When enquiring the data in time point, it will upload the data which is closest to the search point within the reporting interval range. For example, if the device's reporting interval is 10 minutes and users send command to search for 17:00's data, if the device find there is data stored in 17:00, it will upload this data; if not, it will search for data between 16:50 to 17:10 and upload the data which is closest to 17:00.

Example:

Enquire the historical data in a time range.

fd6c 64735b63 7c885b63		
Channel	Type	Value
fd	6c	Start time: 64 73 5b 63 => 63 5b 73 64 = 1666937700s End time: 7c 88 5b 63 => 63 5b 88 7c = 1666943100s

Reply:

fc6c00		
Channel	Type	Value
fc	6c	00: Enquiry success

20ce 0d755b63 0801 57 00			
Channel	Type	Time Stamp	Value
20	ce	0d 75 5b 63 => 63 5b 75 0d=1666938125s	Temperature: 0801=>0108=264/10=26.4 °C Humidity: 57=>87/2=43.5%RH Magnet status: 00=close

Chapter 9. Services

Milesight provides customers with timely and comprehensive technical support services. End-users can contact your local dealer to obtain technical support. Distributors and resellers can contact directly with Milesight for technical support.

Technical Support Mailbox: iot.support@milesight.com

Online Support Portal: <https://support.milesight-iot.com>

Resource Download Center: <https://www.milesight.com/iot/resources/download-center/>

MILESIGHT CHINA

TEL: +86-592-5085280

FAX: +86-592-5023065

Add: Building C09, Software Park Phase III, Xiamen 361024, Fujian, China