



Carbon Dioxide Sensor
EM500-CO2
User Guide

Contents

Chapter 1. Preface.....	4
Chapter 2. Product Introduction.....	6
Overview.....	6
Features.....	6
Chapter 3. Hardware Introduction.....	7
Packing List.....	7
Hardware Overview.....	7
Dimensions(mm).....	7
Power Button.....	8
Chapter 4. Operation Guide.....	9
Access the Sensor.....	9
Access the Sensor via NFC.....	9
Access the Sensor via USB.....	10
LoRaWAN Settings.....	10
Time Synchronization.....	13
General Setting.....	14
Data Collection Settings.....	17
Calibration Settings.....	17
Threshold Settings.....	19
Maintenance.....	21
Upgrade.....	21
Backup and Restore.....	23
Reset to Factory Default.....	25
Chapter 5. Installation.....	27
Installation Location.....	27
EM500 Transceiver Installation.....	27
Chapter 6. Battery Replacing.....	30

Chapter 7. Uplink and Downlink.....	31
Overview.....	31
Uplink Data.....	31
Basic Information.....	32
Periodic Report.....	32
Alarm Report.....	33
Historical Data.....	34
Downlink Command.....	34
General Setting.....	34
Data Collection Settings.....	35
Calibration Settings.....	36
Threshold Setting.....	37
Historical Data Enquiry.....	38
Chapter 8. Services.....	41

Chapter 1. Preface

Copyright Statement

This guide may not be reproduced in any form or by any means to create any derivative such as translation, transformation, or adaptation without the prior written permission of Xiamen Milesight IoT Co., Ltd (Hereinafter referred to as Milesight).

Milesight reserves the right to change this guide and the specifications without prior notice. The latest specifications and user documentation for all Milesight products are available on our official website <http://www.milesight.com>

Safety Instruction

These instructions are intended to ensure that user can use the product correctly to avoid danger or property loss. Milesight will not shoulder responsibility for any loss or damage resulting from not following the instructions of this operating guide.



CAUTION:

Injury or equipment damage may be caused if any of these cautions are neglected.

- The device is not intended to be used as a reference sensor, and Milesight will not should responsibility for any damage which may result from inaccurate readings.
- The device must not be remodeled in any way.
- Do not place the device close to objects with naked flames.
- Do not place the device where the temperature is below/above the operating range.
- Make sure electronic components do not drop out of the enclosure while opening.
- When installing the battery, please install it accurately, and do not install the reverse or wrong model.
- The device must never be subjected to shocks or impacts.
- In order to protect the security of the device, please change device password when first configuration. The default password is 123456.

Revision History

Release Date	Version	Revision Content
November 23, 2020	V1.0	Initial version

Release Date	Version	Revision Content
April 11, 2022	V2.0	Update based on hardware v2.x: 1. Add RX2 datarate and frequency parameters.
May 31, 2023	V2.1	1. Add data storage, retransmission and retrievability feature; 2. Add temperature mutation alarm feature; 3. Add CO ₂ barometric pressure compensation; 4. Add single-channel mode; 5. Add frequency AS923-2&3&4; 6. Add downlink commands: reboot, time settings, data collection; 7. Add sensor installation guide.
March 29, 2024	V2.2	1. Add alarm reporting times and alarm dismiss report feature.
August 15, 2024	V2.2.1	Remove battery insulating sheet

Chapter 2. Product Introduction

Overview

EM500-CO₂ is designed for measuring CO₂, temperature, humidity and barometric pressure in harsh environments and transmitting data using LoRaWAN[®] technology. With this low power consumption technology, EM500-CO₂ can work up to 10 years with 19000 mAh battery. Combining with Milesight LoRaWAN[®] gateway and Milesight Development Platform solution, users can manage all sensor data remotely. EM500-CO₂ is widely used for applications like smart agriculture, smart city, forest fire detection, etc.

Features

- Integrated with multiple sensors like CO₂, temperature, humidity, etc.
- IP65 waterproof enclosure for harsh environment applications
- Ultra-wide-distance transmission up to line of sight of 10km
- Built-in 19000 mAh replaceable battery and work for 10 years without replacement
- Store historical records locally and support retransmission
- Equipped with NFC for easy configuration
- Compliant with standard LoRaWAN[®] gateways and network servers
- Quick and easy management with Milesight IoT Cloud and Milesight Development Platform

Chapter 3. Hardware Introduction

Packing List



1 × EM500 Device

(Include Mounting Bracket)



4 × Wall Mounting Kits



4 × Screw Caps



2 × Fixing Screws



1 × Hose Clamp

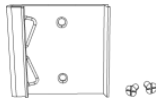

1 × DIN Rail Clip Kit

(Optional)



1 × Quick Guide



1 × Warranty Card



Note:

If any of the above items is missing or damaged, please contact your sales representative.

Hardware Overview

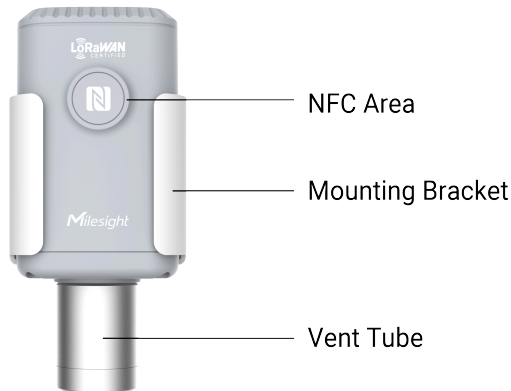

Dimensions(mm)

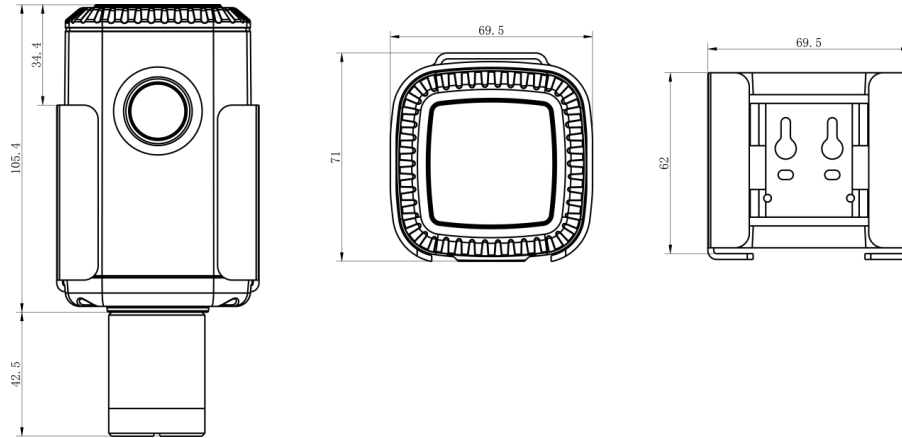

Power Button

There is a LED indicator and a power button inside the device for emergency reboot or reset.

Function	Action	LED Indicator
Power On	Press and hold the button for more than 3 seconds.	Off → On
Power Off		On → Off
Reset to Factory Default	Press and hold the button for more than 10 seconds.	Blinks quickly
Check On/Off Status	Quickly press the power button once.	Light On: device is on.
		Light Off: device is off.

Chapter 4. Operation Guide

Access the Sensor

The device supports local configuration via NFC or USB.

Access the Sensor via NFC

1. Download and install “Milesight ToolBox” App from Google Play or Apple Store on an NFC-supported smartphone.
2. Enable NFC function on the smartphone.
3. Launch Milesight ToolBox, and select the default mode as NFC.
4. Attach the smart phone with NFC area to the device and click  to read device information. Basic information, data, and settings of the device will be shown on the Milesight ToolBox App if it's recognized successfully.
5. Adjust the settings on the App, then attach the smartphone with NFC area to the device and click **Write** to write the settings. After writing, reread the device to check if the configuration is written well.



Note:

- Ensure the location of smartphone NFC area and it's recommended to take off phone case.
- If the smart phone fails to read/write configurations via NFC, keep the phone away and back to try again.
- The default device password is 123456. Please change a new password for security.

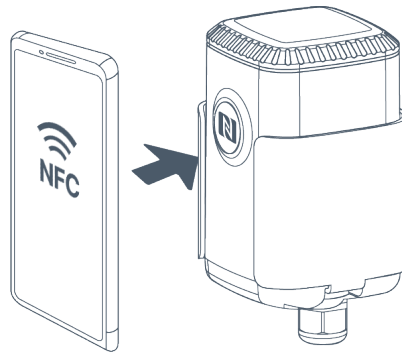

Access the Sensor via USB

1. Download ToolBox software from Milesight official website.
2. Remove the enclosure of the EM500 transceiver, connect the device to a computer via Type-C port.



3. Open the ToolBox and select type as **General**, then click password to log in ToolBox. (Default password: **123456**)

 A screenshot of a software dialog box titled "ToolBox Settings" with a close button (X) in the top right corner. The dialog contains several configuration fields:



- Type: General (dropdown menu)
- Serial port: COM4 (dropdown menu)
- Login password: (empty text input field)
- Baud rate: 115200 (dropdown menu)
- Data bits: 8 (dropdown menu)
- Parity bits: None (dropdown menu)
- Stop bits: 1 (dropdown menu)

 At the bottom of the dialog are two buttons: "Save" and "Cancel".

4. After logging in the ToolBox, users can turn on/off device and change other settings.

LoRaWAN Settings

This chapter describes the LoRaWAN[®] network settings of device.

Parameter	Description
Device EUI	<p>Unique ID of the device which can be found on the device.</p> <p> Note: please contact sales for device EUI list if you have many units.</p>
App EUI	The default App EUI (join EUI) is 24E124C0002A0001.
Application Port	The port used for sending and receiving data, the default port is 85.
LoRaWAN [®] Version	V1.0.2 and V1.0.3 are available.
Work Mode	It's fixed as Class A.
Confirmed Mode	If the device does not receive ACK packet from network server, it will re-send data once.
Join Type	<p>OTAA and ABP mode are available.</p> <p> Note: it's necessary to select OTAA mode if connecting device to Mile-sight IoT Cloud or Milesight Development Platform.</p>
Application Key	<p>Appkey for OTAA mode, default value: "Device EUI" + "Device EUI" (since Q4 of 2025). Example: 24e124123456789024e1241234567890</p> <p> Note:</p> <ul style="list-style-type: none"> The default value of earlier devices is 5572404C696E6B4C6F52613230313823. Please contact sales before purchase if you require random App Keys.
Network Session Key	Nwkskey for ABP mode, the default is 5572404C696E6B4C6F52613230313823.
Application Session Key	Appskey for ABP mode, the default is 5572404C696E6B4C6F52613230313823.
Device Address	DevAddr for ABP mode, default is the 5 th to 12 th digits of SN.

Parameter	Description
Rejoin Mode	<p>Reporting interval ≤ 35 mins: the device will send a specific number of Link-CheckReq MAC packets to the network server every reporting interval or every double reporting interval to validate connectivity; If there is no response, the device will re-join the network.</p> <p>Reporting interval > 35 mins: the device will send a specific number of LinkCheckReq MAC packets to the network server every reporting interval to validate connectivity; If there is no response, the device will re-join the network.</p> <div data-bbox="521 667 1393 961" style="background-color: #e6f2ff; padding: 10px; border-radius: 5px;"> <p> Note:</p> <ol style="list-style-type: none"> 1. Only OTAA mode supports rejoin mode. 2. The actual sending number is Set the number of packets sent + 1. </div>
Channel Mode	Select Standard-Channel mode or Single-Channel mode. When Single-Channel mode is enabled, only one channel can be selected to send uplinks.
Supported Frequency	<p>Enable or disable the frequency to send uplinks. If frequency is one of CN470/AU915/US915, enter the index of the channel to enable in the input box, making them separated by commas.</p> <p>Examples:</p> <p>1, 40: Enabling Channel 1 and Channel 40</p> <p>1-40: Enabling Channel 1 to Channel 40</p> <p>1-40, 60: Enabling Channel 1 to Channel 40 and Channel 60</p> <p>All: Enabling all channels</p> <p>Null: Indicate that all channels are disabled</p>
ADR Mode	Enable or disable network server to adjust Spreading Factor, Bandwidth and Tx Power to optimize data rates, airtime and energy consumption in the network.
Spreading Factor	If ADR mode is disabled, the device will send uplink data following this SF parameter. The higher the spreading factor, the longer the transmission

Parameter	Description
	distance, the slower the transmission speed and the more the consumption.
Tx Power	Tx power (transmit power) refers to the strength of the outgoing signal transmitted by the device. This is defined by LoRa alliance.
RX2 Data Rate	RX2 data rate to receive downlinks.
RX2 Frequency	RX2 frequency to receive downlinks. Unit: Hz

Time Synchronization

This section describes how to sync the time of the device.

Sync via ToolBox App

After reading the device via Milesight ToolBox App, sync the device time with time zone from the smart phone.

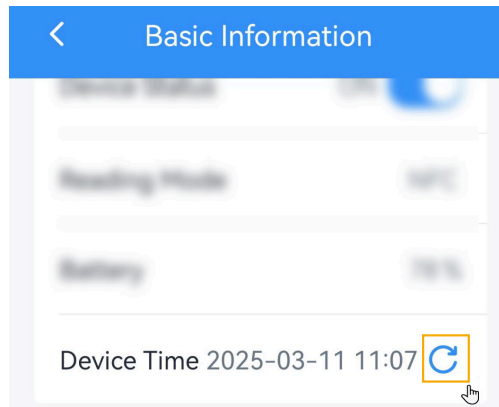
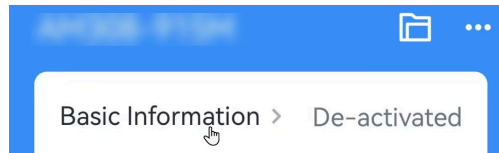

Sync via Network Server

This requires to ensure the LoRaWAN[®] network server supports device time synchronization feature. Example: Milesight gateway embedded NS.

1. Set the LoRaWAN[®] version of the device to V1.0.3.
2. Connect the device to the network server. After joining the network, the device will send a DeviceTimeReq MAC command to enquire the time from network server.



**Note:**

- This only supports to get the time but not time zone. The time zone can be configured by ToolBox App or downlink command.
- The device will send the DeviceTimeReq command every 5 days since the last sync.

General Setting

General settings include the basic parameters of the device.

Parameter	Description
Reporting Interval	The interval to report current data to network server. Range: 1-1080 minutes, Default: 10 minutes.
Temperature Unit	Change the temperature displayed on the ToolBox. <div data-bbox="560 1140 1393 1476" style="border: 1px solid #ccc; border-radius: 10px; padding: 10px; margin-top: 10px;">  Note: <ol style="list-style-type: none"> 1. The temperature unit in the reporting package is fixed as Celsius(°C). 2. Please modify the threshold settings if the unit is changed. </div>
Data Storage	Disable or enable to store periodic report data locally. The stored data can be exported as CSV format file and saved to smartphone via Tool-Box.

Parameter	Description
	<p> Note:</p> <ol style="list-style-type: none"> 1. It is necessary to sync the time to ensure the data is stored in correct time. 2. The device will still store the data even the network status is de-activated. 3. ToolBox App can only export the last 14 days' data at most.
Data Retransmission	<p>Disable or enable data retransmission. When the device detects the network status is de-activated via Rejoin Mode, the device will record a data lost time point and re-transmit the lost data after device re-connects to the network.</p> <p> Note:</p> <ol style="list-style-type: none"> 1. This setting only takes effect when Data Storage is enabled. 2. If the device is rebooted or re-power when data retransmission is not completed, the device will re-send all retransmission data again after device is reconnected to the network. 3. If the network is disconnected again during data retransmission, it will only send the latest disconnected data. 4. The default report data retransmission interval is 600s, this can be changed via downlink command. 5. The reported format of retransmission data will include timestamps and is different from periodic report data. 6. This setting will increase the uplink frequencies and shorten the battery life.
Change Password	<p>Change the device password for ToolBox App to write this device or ToolBox software to log in the device.</p>

Data Collection Settings

Enable or disable the data you need to collect and report.

Device
Network

General
Collection
Calibra
...

When disabled, the sensor will no longer collect the data.

CO2	<input checked="" type="checkbox"/>
Barometric Pressure	<input checked="" type="checkbox"/>
Temperature	<input checked="" type="checkbox"/>
Humidity	<input checked="" type="checkbox"/>

Calibration Settings

Temperature&Humidity&Pressure Calibration

Set the calibration value, the device will add calibration value to the current value, then display and report the final value.

Barometric Pressure	<input type="checkbox"/>
Temperature	<input checked="" type="checkbox"/>
Current Value(°C)	Final Value(°C)
26.7	26.6
Calibration Value(°C)	
-0.1	
Humidity	<input type="checkbox"/>

CO₂ Calibration

The device provides multiple calibration methods for CO₂ calibration. Among them, it is necessary to select either manual calibration or Auto Background calibration to ensure accurate readings.

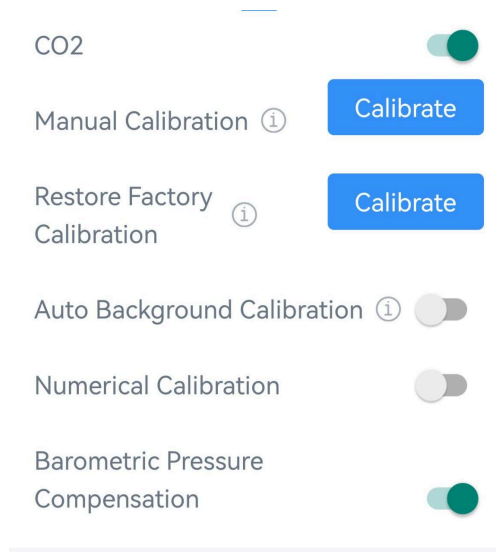

Calibration Method	Description
Manual Calibration	Put the device in an open outdoor environment for more than 10 minutes and click Calibrate button to adjust the current value as calibration value (400 ppm by default) immediately. This calibration is the fastest but it adapts to the open outdoor environment. This calibration is suitable for some applications which need to place CO ₂ sensors in unventilated spaces, you can take sensors out to complete the manual calibration before installation.
Restore Factory Calibration	Clean the manual calibration and turn back to factory calibration.
Auto Background Calibration	After enabled, the device will record the offset between 400ppm and lowest CO ₂ level during a calibration period of 168 hours (7 days) and add this offset to original baseline of sensor to complete the calibration.

Calibration Method	Description
	This calibration is suitable for some applications where CO ₂ sensors are placed in well ventilated or semi-ventilated areas .
Numerical Calibration	Set the calibration value, the device will add calibration value to the current value, then display and report the final value.
Barometric Pressure Compensation	Enable the barometric pressure to compensate the value. This requires to enable the barometric pressure sensor.

Threshold Settings

Threshold Alarm

The device will upload the threshold alarm packet when value is over or below the threshold.

Temperature

Over / °C

20

Below / °C

CO2

Over / ppm

Below / ppm

Collecting Interval(min)

Alarm Reporting Times

Alarm Dismiss Report ⓘ

Parameter	Description
Collect Interval	The interval to collect sensor data. This interval should be less than reporting interval.
Alarm Reporting Times	Alarm packet report times after threshold alarm triggers.
Alarm Dismiss Report	After enabled, when the collected value is not exceeding the threshold range, a packet including current sensor value will be reported to indicate alarm dismiss.

Temperature Mutation Threshold

The device will report an alarm packet when the absolute value of the difference between the current value and the last collected value exceeds the threshold value.

Temperature Shift Threshold ⓘ

Temperature mutation value over(°C)

1

Maintenance

Upgrade

Upgrade via ToolBox App

1. Download firmware from Milesight official website to your smartphone.
2. Read the target device via ToolBox App, click **Upgrade** to upload the firmware file.
3. Click **Upgrade** to upgrade the device.



Note:

Operation on ToolBox is not supported during an upgrade.

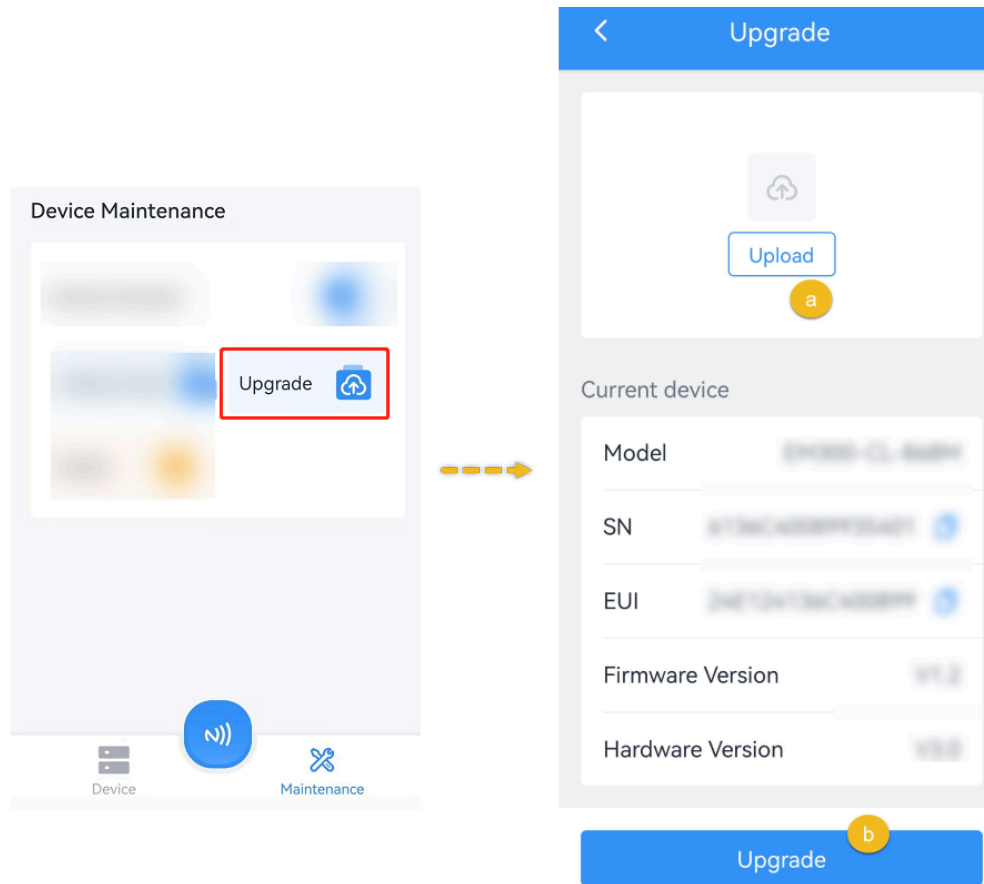

Upgrade via ToolBox Software

1. Download firmware from Milesight official website to your computer.
2. Connect the device to computer via USB port, then log in to the device via ToolBox software.
3. Go to **Maintenance > Upgrade** page, click **Browse** to upload the firmware file and click **Upgrade** to upgrade the device.

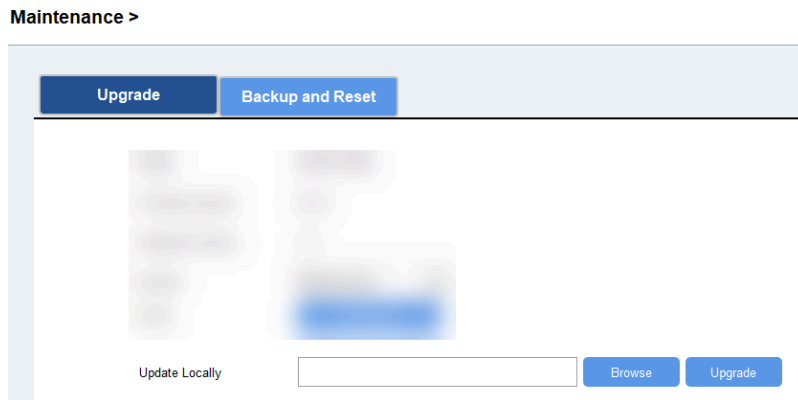

Backup and Restore

This device supports configuration backup for easy and quick device configuration in bulks. Backup and restore is allowed only for devices with the same model and frequency band.

Backup and Restore via ToolBox App

1. Launch ToolBox App, attach the NFC area of smartphone to the device to read the configuration.
2. Edit the configuration as required, click **Set Template** to save current configuration as a template to the ToolBox App.

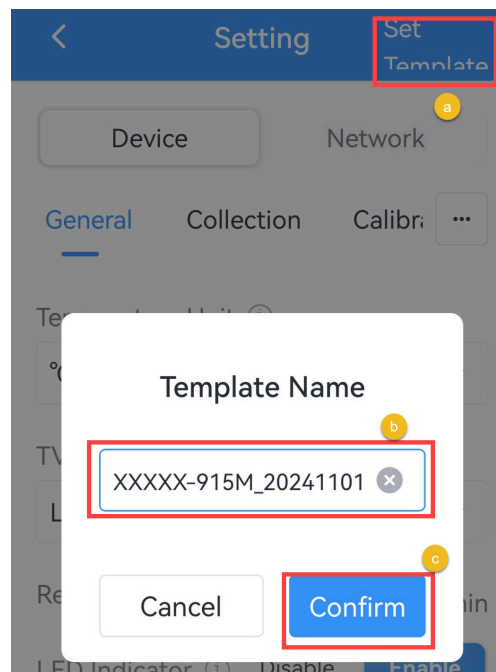

3. Go to **Device >Template** page.



4. Select and click the target template, click **Write** to import the configuration to target devices.

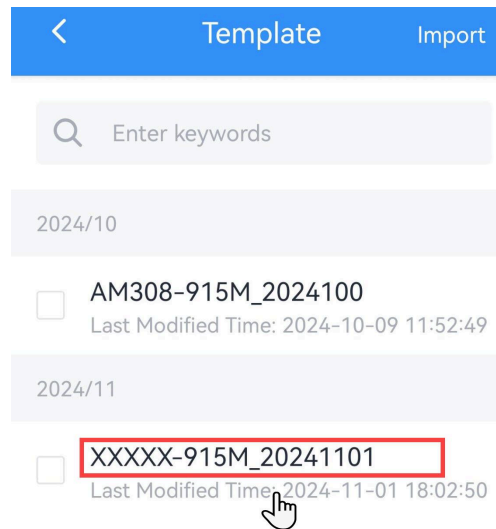

5 (Optional). Check the box of the target template, click **Export** to export this template as JSON format file and save it to the smartphone, click **Delete** to delete this template from your ToolBox App.

Backup and Restore via ToolBox Software

1. Connect the device to a computer via USB port, then log in to the device via ToolBox software.
2. Configure the device and save the settings.
3. Go to **Maintenance > Upgrade** page, click **Export** to save the template file to the computer.
4. Connect another target device to the same computer, go to **Maintenance > Upgrade** page to import the template file.

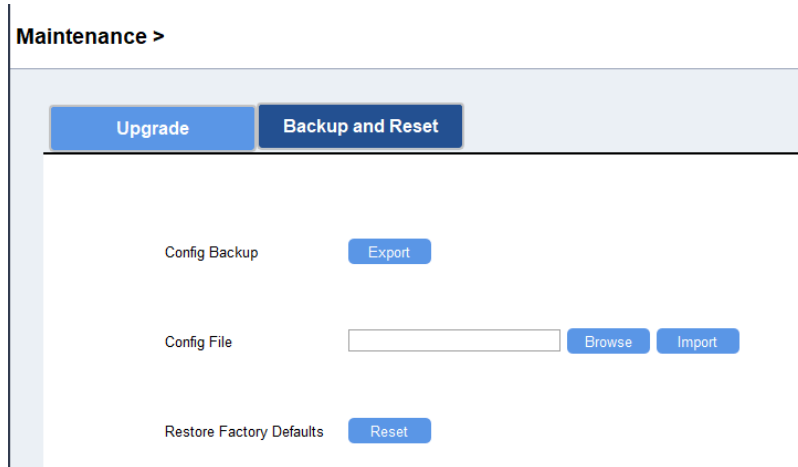

Reset to Factory Default

Via Hardware: Hold on the reset button for more than 10s until the LED indicator quickly blinks.

Via ToolBox App: Click **Reset** and attach the smartphone to device to reset the device.

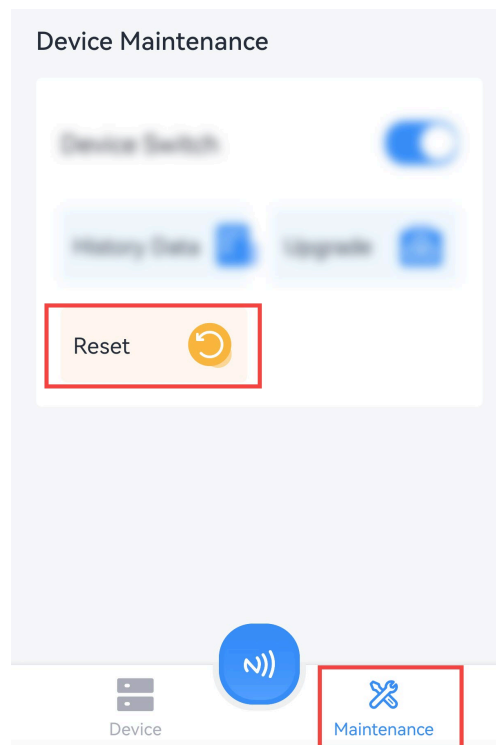

Via ToolBox Software: Go to **Maintenance > Backup and Reset** page, click **Reset** to reset the device.

Upgrade		Backup and Reset	
Config Backup	<input type="button" value="Export"/>		
Config File	<input type="text"/>	<input type="button" value="Browse"/>	<input type="button" value="Import"/>
Restore Factory Defaults	<input type="button" value="Reset"/>		

Chapter 5. Installation

Installation Location

- The device should be mounted no higher than 12-18 inches above the floor since CO₂ is heavier than normal air and will flow down.
- Installation should be considered the layout of a space. Enclosed spaces or varying spaces are recommended to install one more sensor.

EM500 Transceiver Installation

The transceiver supports wall, pole or DIN rail mounting.



Note:

Keep the transceiver away from metal objects and obstacles for better signal.

Wall Mounting

1. Drill two holes in the wall according to the mounting bracket, then secure the wall plugs into the wall.
2. Fix the mounting bracket to the wall via screws.
3. Place the device onto the mounting bracket, then secure it to the bracket with two fixing screws.

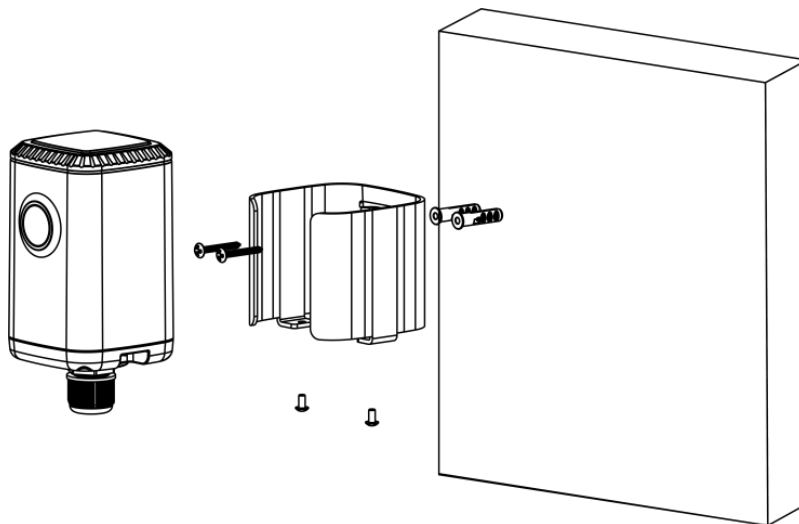

Pole Mounting

Straighten out the hose clamp and slide it through the rectangular holes in the mounting bracket, and wrap the hose clamp around the pole. After that, use a screwdriver to tighten the locking mechanism by turning it clockwise.

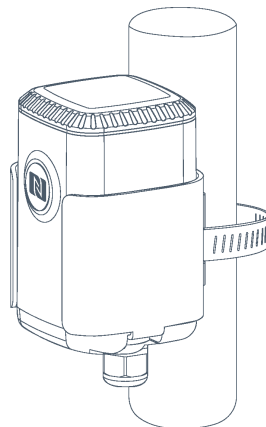
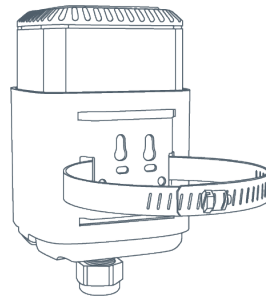

DIN Rail Mounting

Use 2 pcs of M3 × 6 flat head Phillips screws to fix the mount clip to the bracket, and then hang the device on the DIN rail. The width of the DIN rail is 3.5 cm.

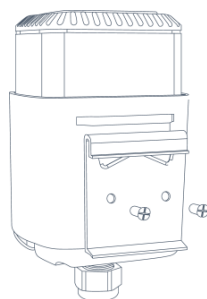

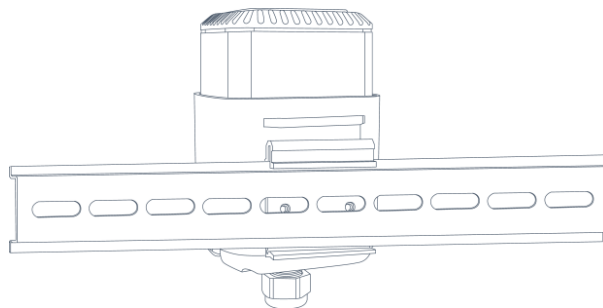

Chapter 6. Battery Replacing

Remove the bottom cover to replace the battery when it has run out of power.

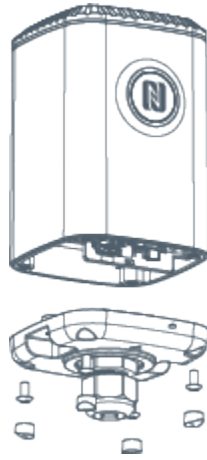

Note:

- The device can only be powered by the ER34615 Li-SoCl₂ battery. The alkaline battery is not supported.
- The battery should be removed or replaced from the device if it is not used for an extended period.
- Ensure the replacing battery is newest; otherwise, it may shorten battery life or cause inaccurate power calculations.

Chapter 7. Uplink and Downlink

Overview

All messages are based on following format (HEX), the Data field should follow little-endian:

Channel1	Type1	Data1	Channel2	Type2	Data2	Channel3	...
1 Byte	1 Byte	N Bytes	1 Byte	1 Byte	N Bytes	1 Byte	...

For decoder examples please find files on <https://github.com/Milesight-IoT/SensorDecoders>.

Uplink Data

This chapter describes the reported data of the device.

Item	Channel	Type	Byte	Description
Power On	ff	0b	1	Device is on
Protocol Version	ff	01	1	Example: 01=V1
Hardware Version	ff	09	2	Example: 03 10 = V3.1
Software Version	ff	0a	2	Example: 03 01 = V3.1
Device Type	ff	0f	1	00: Class A, 01: Class B, 02: Class C, 03: Class C to B
Serial Number	ff	16	8	16 digits
Battery Level	01	75	1	UINT8, Unit: %
Temperature	03	67	2	INT16/10, Unit: °C
Humidity	04	68	1	UINT8/2, Unit: %RH
CO ₂	05	7d	2	UINT16, Unit: ppm
Barometric Pressure	06	73	2	UINT16/10, Unit: hPa
Temperature Mutation Alarm	83	d7	5	Byte 1-2: Temperature, INT16/10, Unit: °C Byte 3-4: Mutation Temperature, INT16/10, Unit: °C Byte 5: 02
Historical Data	20	ce	11	Byte 1-4: Data unix timestamp, UINT32, Unit: s

Item	Channel	Type	Byte	Description
				Byte 5-6: CO ₂ , UINT16, Unit: ppm
				Byte 7-8: Barometric Pressure, UINT16/10, Unit: hPa
				Byte 9-10: Temperature, INT16/10, Unit: °C
				Byte 11: Humidity, UINT8/2, Unit: %RH

**Note:**

When the device fails to collect the sensor data, it will report the value as all ff.

Basic Information

The device will report a basic information packet whenever joining the network.

Example:

ff0bff ff0101 ff166136c40091605408 ff090200 ff0a0101 ff0f00		
Channel	Type	Value
ff	0b	Power on: ff
ff	01	Protocol version: 01=V1
ff	16	SN: 6136c40091605408
ff	09	Hardware version: 0200=V2.0
ff	0a	Software version: 0101=V1.1
ff	0f	00: Class A

Periodic Report

The device supports to report below types of periodic report packets.

1. Sensor data: report according to reporting interval.

03671001 046871 057dcd04 06735127		
Channel	Type	Value
03	67	Temperature: 1001=> 0110 = 272/10=27.2°C
04	68	Humidity: 71 => 113/2=56.5 %RH

03671001 046871 057dcd04 06735127		
Channel	Type	Value
05	7d	CO ₂ : cd 04 => 04 cd=1229 ppm
06	73	Barometric Pressure: 51 27=>27 51=10065/10=1006.5 hPa

- Battery level: report when the device joins the network or every 24 hours.

017564		
Channel	Type	Value
01	75	Battery: 64=>100%

Alarm Report

The device supports to report below types of alarm report packets.

- Threshold alarm or alarm dismiss. The alarm report format is the same as periodic report.

03671001		
Channel	Type	Value
03	67	Temperature: 1001=> 0110 = 272/10=27.2°C

- Temperature mutation alarm

83d722010c0002		
Channel	Type	Value
83	d7	Temperature: 22 01 => 01 22 => 290/10 = 29°C Mutation Value: 0c 00 => 00 0c => 12/10=1.2°C 02 = Mutation Alarm

- Low battery level alarm: report when battery level is below to 1%.

017501		
Channel	Type	Value
01	75	Battery: 01=>1%

Historical Data

The device will report retransmission data or stored data as below example.

20ce 0d755b63 c9036427010175			
Channel	Type	Time Stamp	Value
20	ce	0d 75 5b 63 => 63 5b 75 0d=1666938125s	CO ₂ : c9 03 => 03 c9 = 969ppm Pressure: 64 27 => 27 64=10084/10=1008.4 hPa Temperature: 01 01=>01 01=257/10=25.7°C Humidity: 75=>117/2=58.5%

Downlink Command

This chapter describes the downlink commands for device configuration and control. The downlink application port is 85 by default.

General Setting

Item	Channel	Type	Byte	Description
Reboot	ff	10	1	ff
Collect Interval	ff	02	2	UINT16, Unit: s
Re-collect Setting	ff	1c	2	Byte 1: re-collect times Byte 2-3: re-collect interval
Report Interval	ff	03	2	UINT16, Unit: s
Data Storage	ff	68	1	00: Disable, 01: Enable
Data Retransmission	ff	69	1	00: Disable, 01: Enable
Data Retransmission Interval	ff	6a	3	Byte 1: 00 Byte 2-3: UINT16, Unit: s, Range: 30~1200, Default: 600
UTC Time Zone	ff	17	2	INT16/10
Device Time	ff	11	4	Unix timestamp, Unit: s
Sync with with LNS	ff	4a	1	ff

Example:

1. Reboot the device.

ff10ff

2. Set collect interval as 20 minutes.

ff02b004		
Channel	Type	Value
ff	02	b004=>04b0=1200s=20 minutes

3. Set report interval as 20 minutes.

ff03b004		
Channel	Type	Value
ff	03	b004=>04b0=1200s=20 minutes

4. Set time zone as UTC-2.

ff17ecff		
Channel	Type	Value
ff	17	ecff=>ff ec=-20/10=-2

Data Collection Settings

Item	Channel	Type	Byte	Description
Sensor Status	ff	18	2	Byte 1: 00=All, 01=Temperature, 02=Humidity, 05=CO ₂ , 06=Barometric Pressure Byte 2: 00=Disable, 01=Enable

Example:

1. Disable temperature sensor.

ff180101		
Channel	Type	Value
ff	18	01=Temperature, 00=Disable

Calibration Settings

Item	Channel	Type	Byte	Description
Temperature Calibration	ff	f1	4	Byte 1: 00 Byte 2: 00-disable, 01-enable Byte 3-4: Calibration value, INT16/10, Unit: °C
CO ₂ Numerical Calibration	ff	f1	4	Byte 1: 04 Byte 2: 00-disable, 01-enable Byte 3-4: Calibration value, INT16, Unit: ppm
CO ₂ Calibration	ff	1a	1	00=Restore Factory Calibration 03=Manual Calibration
Auto Background Calibration	ff	39	5	Byte 1: 00-disable, 01-enable Bytes 2-3: Calibration period, unit: hour Bytes 4-5: Calibration value, unit: ppm
Pressure/Altitude Compensation	ff	87	3	Byte 1: 00-disable, 01-barometric pressure compensation, 03-altitude compensation Bytes 2-3: Altitude value, unit: m, range: 0-5000

Example:

1. Enable temperature calibration and set calibration value.

fff10001fdff		
Channel	Type	Value
ff	f1	00=Temperature, 01=Enable fdff=>fffd=-3/10=-0.3 °C

2. CO₂ manual calibration after putting device to outdoors for more than 10 minutes.

ff1a03		
Channel	Type	Value
ff	1a	03=Manual Calibration

3. Enable Auto Background Calibration, set calibration period as 168 hours (7 days) and the value as 400 ppm.

ff3901a8009001		
Channel	Type	Value
ff	39	01=Enable a8 00 => 00 a8=168h 90 01 => 01 90= 400 ppm

Threshold Setting

Item	Channel	Type	Byte	Description
Temperature Threshold Alarm	ff	06	9	Byte 1: 10=Disable, 51=Below (min. threshold), 52=Over (max. threshold), 53=Within, 54=Below or over Byte 2-3: Minimum threshold, INT16/10, Unit: °C Byte 4-5: Maximum threshold, INT16/10, Unit: °C Byte 6-9: 00000000
CO ₂ Threshold Alarm	ff	06	9	Byte 1: 08=Disable, 49=Below (min. threshold), 4a=Over (max. threshold), 4b=Within, 4c=Below or over Byte 2-3: Minimum threshold, UINT16, Unit: ppm Byte 4-5: Maximum threshold, UINT16, Unit: ppm Byte 6-9: 00000000
Temperature Mutation Alarm	ff	06	9	Byte 1: 1d=Disable, 5d=Enable Byte 2-3: 0000 Byte 4-5: Mutation threshold, INT16/10, Unit: °C Byte 6-9: 00000000
Alarm Reporting Times	ff	f2	2	UINT16
Alarm Dismiss Report	ff	f5	1	00-disable, 01-enable

Example:

1. Set a temperature threshold as below 15°C or over 30°C.

ff065496002c0100000000		
Channel	Type	Value
ff	06	54=Below or over Min. threshold: 96 00=>00 96=150/10=15°C Max. threshold: 2c 01 => 01 2c =300/10=30°C

Historical Data Enquiry

This chapter describes data retrievability feature to send downlink command to enquire the historical data stored in the device. Before that, ensure the device time is correct and data storage feature was enabled to store data.

Command Format:

Item	Channel	Type	Byte	Description
Enquire Data in Time Point	fd	6b	4	Unix timestamp, Unit: s
Enquire Data in Time Range	fd	6c	8	Byte 1-4: Start timestamp, Unit: s Byte 5-8: End timestamp, Unit: s
Stop Query Data Report	fd	6d	1	ff
Data Retrievability Interval	ff	6a	3	Byte 1: 01 Byte 2-3: UINT16, Unit: s, Range: 30~1200, Default: 60

Reply Format:

Item	Channel	Type	Byte	Description
Enquiry Result	fc	6b/6c	1	00: Enquiry success. The device will report the historical data according to data retrievability interval.

Item	Channel	Type	Byte	Description
				01: Time point or time range invalid 02: No data in this time or time range



Note:

1. Use [Unix Timestamp Converter](#) to calculate the time.
2. The device only uploads no more than 300 data records per range enquiry.
3. When enquiring the data in time point, it will upload the data which is closest to the search point within the reporting interval range. For example, if the device's reporting interval is 10 minutes and users send command to search for 17:00's data, if the device find there is data stored in 17:00, it will upload this data; if not, it will search for data between 16:50 to 17:10 and upload the data which is closest to 17:00.

Example:

Enquire the historical data in a time range.

fd6c 64735b63 7c885b63		
Channel	Type	Value
fd	6c	Start time: 64 73 5b 63 => 63 5b 73 64 = 1666937700s End time: 7c 88 5b 63 => 63 5b 88 7c = 1666943100s

Reply:

fc6c00		
Channel	Type	Value
fc	6c	00: Enquiry success

20ce 0d755b63 c9036427010175			
Channel	Type	Time Stamp	Value
20	ce	0d 75 5b 63 => 63 5b 75 0d=1666938125s	CO ₂ : c9 03 => 03 c9 = 969ppm Pressure: 64 27 => 27 64=10084/10=1008.4 hPa

20ce 0d755b63 c9036427010175			
Channel	Type	Time Stamp	Value
			Temperature: 01 01=>01 01=257/10=25.7°C Humidity: 75=>117/2=58.5%

Chapter 8. Services

Milesight provides customers with timely and comprehensive technical support services. End-users can contact your local dealer to obtain technical support. Distributors and resellers can contact directly with Milesight for technical support.

Technical Support Mailbox: iot.support@milesight.com

Online Support Portal: <https://support.milesight-iot.com>

Resource Download Center: <https://www.milesight.com/iot/resources/download-center/>

MILESIGHT CHINA

TEL: +86-592-5085280

FAX: +86-592-5023065

Add: Building C09, Software Park Phase III, Xiamen 361024, Fujian, China