



# Pipe Pressure Sensor

EM500-PP

User Guide

# Contents

<b>Chapter 1. Preface.....</b>	<b>4</b>
<b>Chapter 2. Product Introduction.....</b>	<b>6</b>
Overview.....	6
Features.....	6
<b>Chapter 3. Hardware Introduction.....</b>	<b>7</b>
Packing List.....	7
Hardware Overview.....	7
Dimensions(mm).....	8
Power Button.....	8
<b>Chapter 4. Sensor Assembly.....</b>	<b>9</b>
<b>Chapter 5. Operation Guide.....</b>	<b>11</b>
Access the Sensor.....	11
Access the Sensor via NFC.....	11
Access the Sensor via USB.....	12
LoRaWAN Settings.....	12
Time Synchronization.....	15
General Setting.....	16
Calibration Settings.....	19
Threshold Settings.....	19
Milesight D2D Setting.....	20
Maintenance.....	22
Upgrade.....	22
Backup and Restore.....	24
Reset to Factory Default.....	26
<b>Chapter 6. Installation.....</b>	<b>27</b>
EM500 Transceiver Installation.....	27
Pipe Sensor Installation.....	29

<b>Chapter 7. Battery Replacing</b> .....	<b>30</b>
<b>Chapter 8. Uplink and Downlink</b> .....	<b>31</b>
Overview.....	31
Uplink Data.....	31
Basic Information.....	32
Periodic Report.....	32
Alarm Report.....	33
Historical Data.....	33
Downlink Command.....	33
General Setting.....	34
Calibration Setting.....	35
Threshold Setting.....	35
D2D Setting.....	36
Historical Data Enquiry.....	37
<b>Chapter 9. Services</b> .....	<b>40</b>

# Chapter 1. Preface

## Copyright Statement

This guide may not be reproduced in any form or by any means to create any derivative such as translation, transformation, or adaptation without the prior written permission of Xiamen Milesight IoT Co., Ltd (Hereinafter referred to as Milesight).

*Milesight* reserves the right to change this guide and the specifications without prior notice. The latest specifications and user documentation for all Milesight products are available on our official website <http://www.milesight.com>

## Safety Instruction

These instructions are intended to ensure that user can use the product correctly to avoid danger or property loss. Milesight will not shoulder responsibility for any loss or damage resulting from not following the instructions of this operating guide.

**CAUTION:**

Injury or equipment damage may be caused if any of these cautions are neglected.

- The device is not intended to be used as a reference sensor, and Milesight will not shoulder responsibility for any damage which may result from inaccurate readings.
- The device must not be remodeled in any way.
- Do not place the device close to objects with naked flames.
- Do not place the device where the temperature is below/above the operating range.
- Make sure electronic components do not drop out of the enclosure while opening.
- When installing the battery, please install it accurately, and do not install the reverse or wrong model.
- The device must never be subjected to shocks or impacts.
- In order to protect the security of the device, please change device password when first configuration. The default password is 123456.

## Revision History

Release Date	Version	Revision Content
November 23, 2020	V1.0	Initial version
April 11, 2022	V2.0	Update based on hardware v2.x:  <ol style="list-style-type: none"> <li>1. Add new model EM500-PP-G1/2M-4842;</li> <li>2. Add RX2 datarate and frequency parameters.</li> </ol>
May 31, 2023	V2.1	<ol style="list-style-type: none"> <li>1. Add data storage, retransmission and retrievability feature;</li> <li>2. Add single-channel mode;</li> <li>3. Add frequency AS923-2&amp;3&amp;4;</li> <li>4. Add downlink commands: reboot, time settings;</li> <li>5. Add sensor installation guide.</li> </ol>
March 29, 2024	V2.2	<ol style="list-style-type: none"> <li>1. Add Milesight D2D controller feature;</li> <li>2. Add alarm reporting times and alarm dismiss report feature.</li> </ol>
August 15, 2024	V2.2.1	Remove battery insulating sheet

## Chapter 2. Product Introduction

### Overview

EM500-PP is designed for measuring pipe pressure in harsh environments and transmitting data using LoRaWAN<sup>®</sup> technology. With this low power consumption technology, EM500-PP can work up to 10 years with 19000 mAh battery. Combining with Mulesight LoRaWAN<sup>®</sup> gateway and Mulesight Development Platform, users can manage all sensor data remotely and visually.

EM500-PP is widely used for applications like smart buildings, pipeline and tank systems monitoring, etc.

### Features

- High precision and corrosion resistance
- Ultra-wide-distance transmission up to line of sight of 10km
- Built-in 19000 mAh replaceable battery and work for 10 years without replacement
- Store historical records locally and support retransmission
- Equipped with NFC for easy configuration
- Compliant with standard LoRaWAN<sup>®</sup> gateways and network servers
- Quick and easy management with Mulesight IoT Cloud and Mulesight Development Platform

# Chapter 3. Hardware Introduction

## Packing List



1 × EM500 Device



4 × Wall Mounting Kits



4 × Screw Caps



2 × Fixing Screws

(Include Mounting Bracket)



1 × Hose Clamp

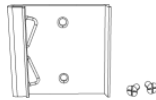

1 × DIN Rail Clip Kit

(Optional)



1 × Quick Guide



1 × Warranty Card



### Note:

If any of the above items is missing or damaged, please contact your sales representative.

## Hardware Overview

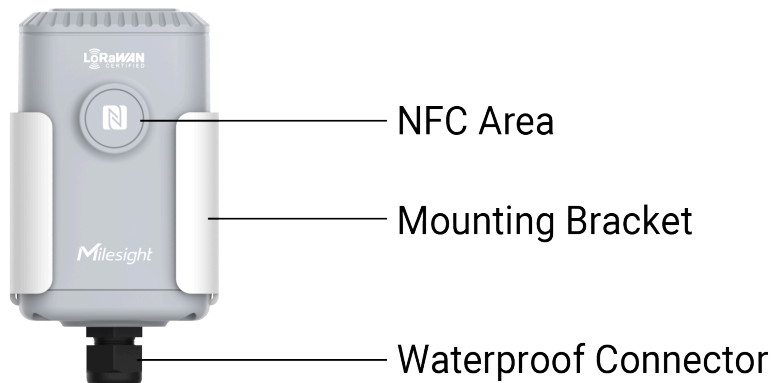

**Sensor Terminal Block (Internal):**

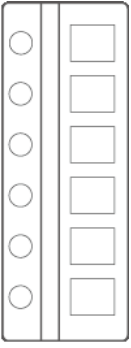
Pin	Number	Description
	1	White/GND
	2	Red/AIN
	3	--
	4	--
	5	--
	6	Black/VOUT=12V

### Dimensions(mm)

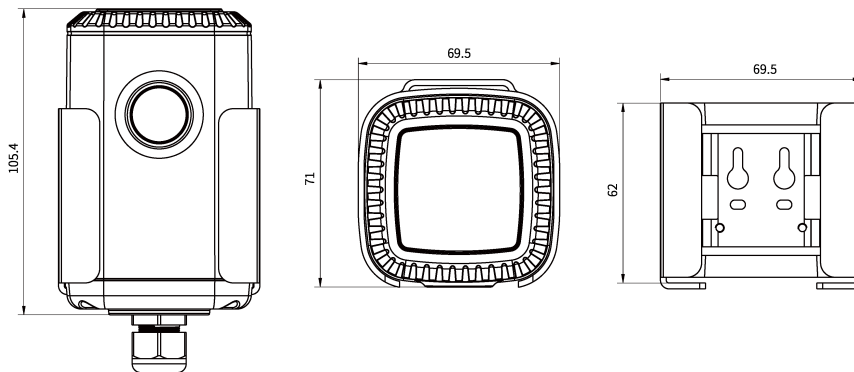

### Power Button

There is a LED indicator and a power button inside the device for emergency reboot or reset.

Function	Action	LED Indicator
Power On	Press and hold the button for more than 3 seconds.	Off → On
Power Off		On → Off
Reset to Factory Default	Press and hold the button for more than 10 seconds.	Blinks quickly
Check On/Off Status	Quickly press the power button once.	Light On: device is on.
		Light Off: device is off.

## Chapter 4. Sensor Assembly

It is necessary to connect the sensor to the EM500 transceiver to make the whole device work.

1. Take off the mounting bracket on the transceiver, remove the screws and the bottom cover with the waterproof connector.

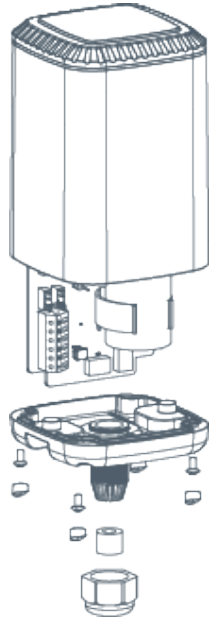

2. Pass all sensor wires through the waterproof connector and leave sufficient length for connecting to the EM500 transceiver, then tighten the waterproof connector to the bottom cover.

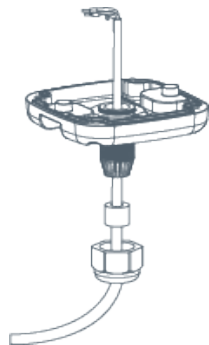

3. Screw the sensor wires to the terminal block of the EM500 transceiver tightly referring to the label or Hardware Overview section. After wiring, gently pull the wires to ensure they are securely fastened to the transceiver.



**Note:**

The pipe sensor has two red wires. Please choose any one of them to connect.

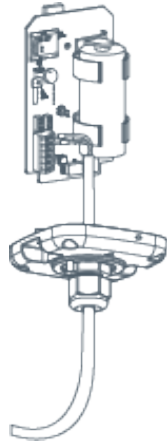

4. Restore everything to its due position. When restoring the bottom cover, ensure the red arrow faces the front of the transceiver.



**Note:**

The rubber seal and rubber screw caps should be installed accordingly to prevent water from entering.

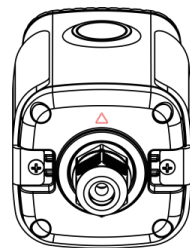
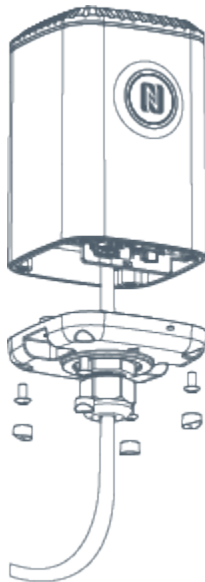

# Chapter 5. Operation Guide

## Access the Sensor

The device supports local configuration via NFC or USB.

### Access the Sensor via NFC

1. Download and install "Milesight ToolBox" App from Google Play or Apple Store on an NFC-supported smartphone.
2. Enable NFC function on the smartphone.
3. Launch Milesight ToolBox, and select the default mode as NFC.
4. Attach the smart phone with NFC area to the device and click  to read device information. Basic information, data, and settings of the device will be shown on the Milesight ToolBox App if it's recognized successfully.
5. Adjust the settings on the App, then attach the smartphone with NFC area to the device and click **Write** to write the settings. After writing, reread the device to check if the configuration is written well.



#### Note:

- Ensure the location of smartphone NFC area and it's recommended to take off phone case.
- If the smart phone fails to read/write configurations via NFC, keep the phone away and back to try again.
- The default device password is 123456. Please change a new password for security.

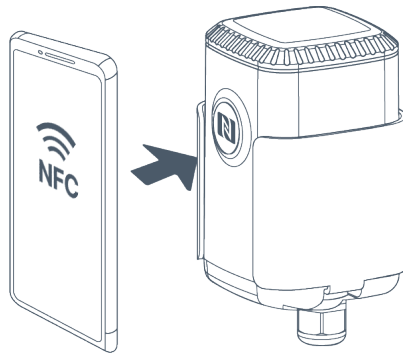

## Access the Sensor via USB

1. Download ToolBox software from Milesight official website.
2. Remove the enclosure of the EM500 transceiver, connect the device to a computer via Type-C port.



3. Open the ToolBox and select type as **General**, then click password to log in ToolBox. (Default password: **123456**)

**ToolBox Settings**
✕

Type General ▾

Serial port COM4 ▾

Login password

Baud rate 115200 ▾

Data bits 8 ▾

Parity bits None ▾

Stop bits 1 ▾



Save
Cancel

4. After logging in the ToolBox, users can turn on/off device and change other settings.

## LoRaWAN Settings

This chapter describes the LoRaWAN<sup>®</sup> network settings of device.

Parameter	Description
Device EUI	Unique ID of the device which can be found on the device.

Parameter	Description
	 <b>Note:</b> please contact sales for device EUI list if you have many units.
App EUI	The default App EUI (join EUI) is 24E124C0002A0001.
Application Port	The port used for sending and receiving data, the default port is 85.
LoRaWAN <sup>®</sup> Version	V1.0.2 and V1.0.3 are available.
Work Mode	It's fixed as Class A.
Confirmed Mode	If the device does not receive ACK packet from network server, it will resend data once.
Join Type	OTAA and ABP mode are available.   <b>Note:</b> it's necessary to select OTAA mode if connecting device to Milesight IoT Cloud or Milesight Development Platform.
Application Key	Appkey for OTAA mode, default value: "Device EUI" + "Device EUI" (since Q4 of 2025). Example: 24e124123456789024e1241234567890   <b>Note:</b> <ul style="list-style-type: none"> <li>• The default value of earlier devices is 5572404C696E6B4C6F52613230313823.</li> <li>• Please contact sales before purchase if you require random App Keys.</li> </ul>
Network Session Key	Nwkskey for ABP mode, the default is 5572404C696E6B4C6F52613230313823.
Application Session Key	Appskey for ABP mode, the default is 5572404C696E6B4C6F52613230313823.

Parameter	Description
Device Address	DevAddr for ABP mode, default is the 5 <sup>th</sup> to 12 <sup>th</sup> digits of SN.
Rejoin Mode	<p>Reporting interval ≤ 35 mins: the device will send a specific number of Link-CheckReq MAC packets to the network server every reporting interval or every double reporting interval to validate connectivity; If there is no response, the device will re-join the network.</p> <p>Reporting interval &gt; 35 mins: the device will send a specific number of Link-CheckReq MAC packets to the network server every reporting interval to validate connectivity; If there is no response, the device will re-join the network.</p> <div data-bbox="511 724 1416 1018" style="background-color: #e6f2ff; padding: 10px; border: 1px solid #add8e6;"> <p> <b>Note:</b></p> <ol style="list-style-type: none"> <li>1. Only OTAA mode supports rejoin mode.</li> <li>2. The actual sending number is <b>Set the number of packets sent</b> +1.</li> </ol> </div>
Channel Mode	Select <b>Standard-Channel</b> mode or <b>Single-Channel</b> mode. When <b>Single-Channel</b> mode is enabled, only one channel can be selected to send uplinks.
Supported Frequency	<p>Enable or disable the frequency to send uplinks. If frequency is one of CN470/AU915/US915, enter the index of the channel to enable in the input box, making them separated by commas.</p> <p><b>Examples:</b></p> <p>1, 40: Enabling Channel 1 and Channel 40</p> <p>1-40: Enabling Channel 1 to Channel 40</p> <p>1-40, 60: Enabling Channel 1 to Channel 40 and Channel 60</p> <p>All: Enabling all channels</p> <p>Null: Indicate that all channels are disabled</p>
ADR Mode	Enable or disable network server to adjust Spreading Factor, Bandwidth and Tx Power to optimize data rates, airtime and energy consumption in the network.

Parameter	Description
Spreading Factor	If ADR mode is disabled, the device will send uplink data following this SF parameter. The higher the spreading factor, the longer the transmission distance, the slower the transmission speed and the more the consumption.
Tx Power	Tx power (transmit power) refers to the strength of the outgoing signal transmitted by the device. This is defined by LoRa alliance.
RX2 Data Rate	RX2 data rate to receive downlinks or send D2D commands.
RX2 Frequency	RX2 frequency to receive downlinks or send D2D commands. Unit: Hz

## Time Synchronization

This section describes how to sync the time of the device.

### Sync via ToolBox App

After reading the device via Milesight ToolBox App, sync the device time with time zone from the smart phone.

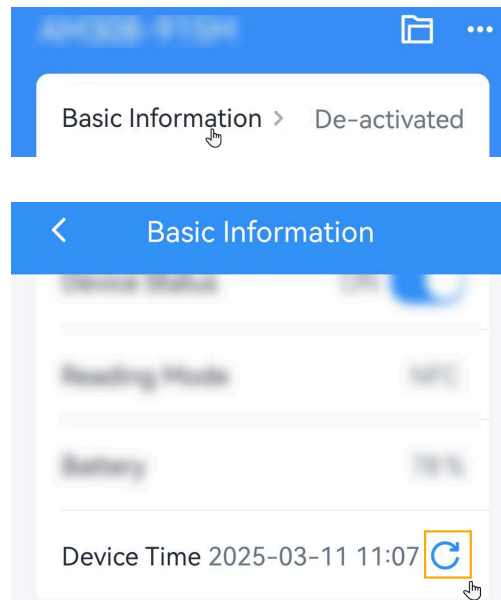

### Sync via Network Server

This requires to ensure the LoRaWAN<sup>®</sup> network server supports device time synchronization feature. Example: Milesight gateway embedded NS.

1. Set the LoRaWAN<sup>®</sup> version of the device to V1.0.3.
2. Connect the device to the network server. After joining the network, the device will send a DeviceTimeReq MAC command to enquire the time from network server.

**Note:**



- This only supports to get the time but not time zone. The time zone can be configured by ToolBox App or downlink command.
- The device will send the DeviceTimeReq command every 5 days since the last sync.

## General Setting

General settings include the basic parameters of the device.

Parameter	Description
Reporting Interval	The interval to report current data to network server. Range: 1-1080 minutes, Default: 10 minutes.
Pressure Unit	<p>Change the pressure unit displayed on the ToolBox.</p> <div style="border: 1px solid #ccc; background-color: #e6f2ff; padding: 10px; margin-top: 10px;"> <p> <b>Note:</b></p> <ol style="list-style-type: none"> <li>1. The pressure unit in the reporting package is fixed as kPa.</li> <li>2. Please modify the threshold settings if the unit is changed.</li> </ol> </div>
Data Storage	Disable or enable to store <b>periodic report</b> data locally. The stored data can be exported as CSV format file and saved to smartphone via ToolBox.



Parameter	Description
	<p> <b>Note:</b></p> <ol style="list-style-type: none"> <li>1. It is necessary to <a href="#">sync the time</a> to ensure the data is stored in correct time.</li> <li>2. The device will still store the data even the network status is de-activated.</li> <li>3. ToolBox App can only export the last 14 days' data at most.</li> </ol>
Data Retransmission	<p>Disable or enable data retransmission. When the device detects the network status is de-activated via <a href="#">Rejoin Mode</a>, the device will record a data lost time point and re-transmit the lost data after device re-connects to the network.</p> <p> <b>Note:</b></p> <ol style="list-style-type: none"> <li>1. This setting only takes effect when <a href="#">Data Storage</a> is enabled.</li> <li>2. If the device is rebooted or re-power when data retransmission is not completed, the device will re-send all retransmission data again after device is reconnected to the network.</li> <li>3. If the network is disconnected again during data retransmission, it will only send the latest disconnected data.</li> <li>4. The default report data retransmission interval is 600s, this can be changed via downlink command.</li> <li>5. The reported format of retransmission data will include timestamps and is different from periodic report data.</li> <li>6. This setting will increase the uplink frequencies and shorten the battery life.</li> </ol>
Change Password	Change the device password for ToolBox App to write this device or ToolBox software to log in the device.

## Calibration Settings

### Numerical Calibration

Set the calibration value, the device will add calibration value to the current value, then display and report the final value.

General **Calibration** Threshold

Pressure

Current Value(kPa)	Final Value(kPa)
<b>0</b>	<b>-0.1</b>

Calibration Value(kPa)

## Threshold Settings

### Threshold Alarm

The device will upload the threshold alarm packet when value is over or below the threshold.

Device
Network

General
Calibration
Threshold

Pressure

Over / kPa

500

Below / kPa

---

Collecting Interval(min)

1

Alarm Reporting Times

1

Alarm Dismiss Report  ⓘ

Parameter	Description
Collect Interval	The interval to collect sensor data. This interval should be less than reporting interval.
Alarm Reporting Times	Alarm packet report times after threshold alarm triggers.
Alarm Dismiss Report	After enabled, when the collected value is not exceeding the threshold range, a packet including current sensor value will be reported to indicate alarm dismiss.

## Milesight D2D Setting

Milesight D2D protocol is developed by Milesight and used for setting up transmission among Milesight devices without gateway. When the Milesight D2D settings is enabled, the device can work as a D2D controller to send control commands to trigger Milesight D2D agent devices.

1. Configure the RX2 datarate and RX2 frequency.



**Note:**

It is suggested to change the default values if there are many LoRaWAN® devices around.

Device
Network

LoRaWAN D2D

---

Spreading Factor ⓘ

SF12-DR0
▼

TXPower

TXPower0-16 dBm
▼

---

RX2 Data Rate ⓘ

DR0 (SF12, 125 kHz)
▼

RX2 Frequency ⓘ

869525000
▼

2. Enable and configure the threshold alarm settings.

3. Enable Milesight D2D feature and define a unique D2D key that is the same as Milesight D2D agent devices. (Default D2D key: 5572404C696E6B4C6F52613230313823)

Device
Network

LoRaWAN D2D

Enable

D2D Key

\*\*\*\*\*
▼

4. Enable one of alarm statuses and configure 2-byte hexadecimal Milesight D2D command.



**Note:**

If you enable **LoRa Uplink**, a LoRaWAN<sup>®</sup> uplink packet that contains corresponding alarm status will be sent to gateway after the Milesight D2D command packet. Otherwise, the alarm packet will not send to LoRaWAN<sup>®</sup> gateway.

**Example:** When the pressure value reaches the threshold, the device will send command ff01 to D2D agent devices.

Pressure Threshold Triggered

Control command

ff01

LoRa Uplink ⓘ

---

Pressure Threshold Released

## Maintenance

### Upgrade

#### Upgrade via ToolBox App

1. Download firmware from Milesight official website to your smartphone.
2. Read the target device via ToolBox App, click **Upgrade** to upload the firmware file.
3. Click **Upgrade** to upgrade the device.



**Note:**

Operation on ToolBox is not supported during an upgrade.

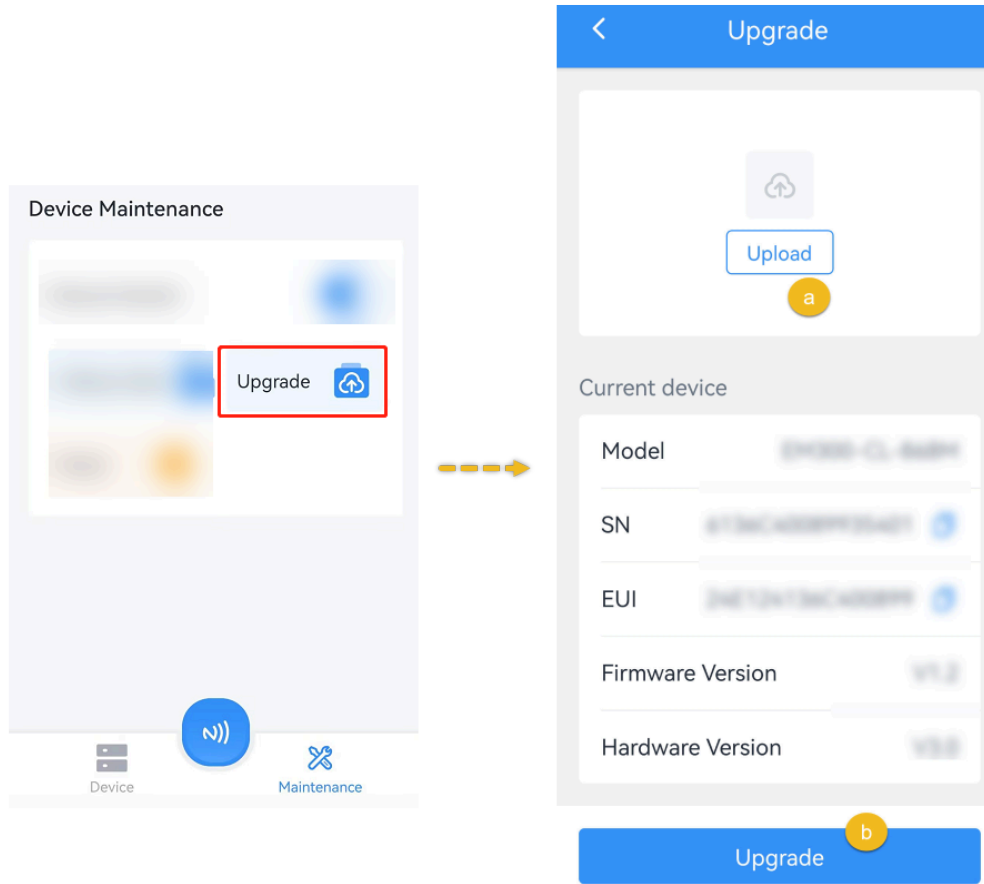

### Upgrade via ToolBox Software

1. Download firmware from Milesight official website to your computer.
2. Connect the device to computer via USB port, then log in to the device via ToolBox software.
3. Go to **Maintenance > Upgrade** page, click **Browse** to upload the firmware file and click **Upgrade** to upgrade the device.

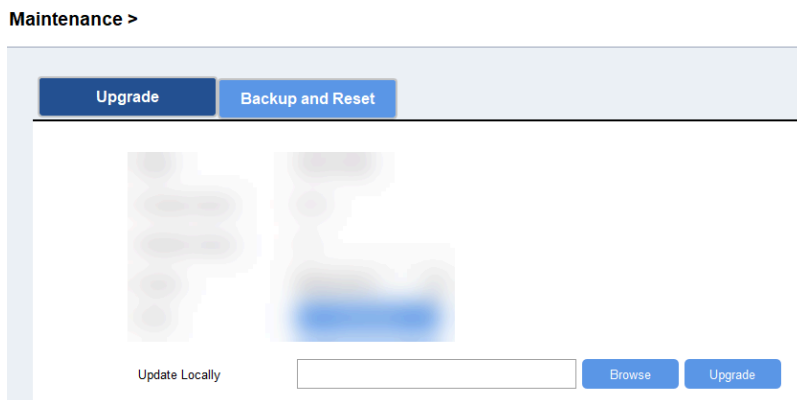

## Backup and Restore

This device supports configuration backup for easy and quick device configuration in bulks. Backup and restore is allowed only for devices with the same model and frequency band.

### Backup and Restore via ToolBox App

1. Launch ToolBox App, attach the NFC area of smartphone to the device to read the configuration.
2. Edit the configuration as required, click **Set Template** to save current configuration as a template to the ToolBox App.

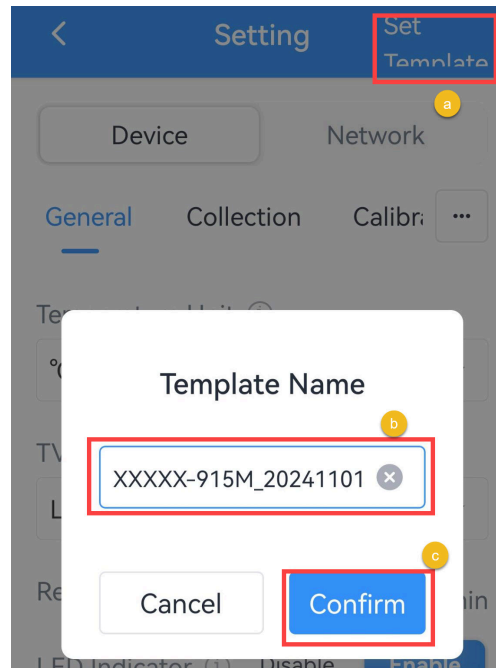

3. Go to **Device >Template** page.



4. Select and click the target template, click **Write** to import the configuration to target devices.

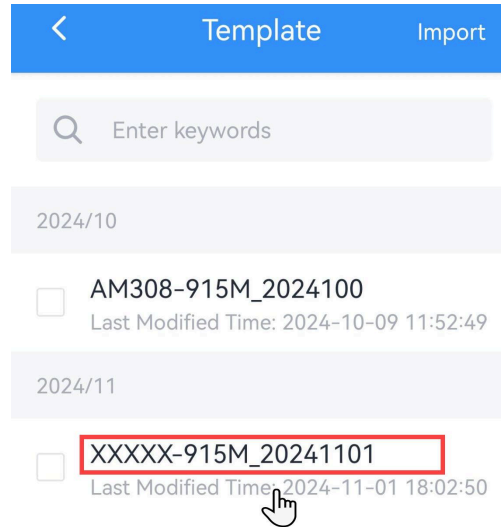

5 (Optional). Check the box of the target template, click **Export** to export this template as JSON format file and save it to the smartphone, click **Delete** to delete this template from your Toolbox App.

### Backup and Restore via Toolbox Software

1. Connect the device to a computer via USB port, then log in to the device via Toolbox software.
2. Configure the device and save the settings.
3. Go to **Maintenance > Upgrade** page, click **Export** to save the template file to the computer.
4. Connect another target device to the same computer, go to **Maintenance > Upgrade** page to import the template file.

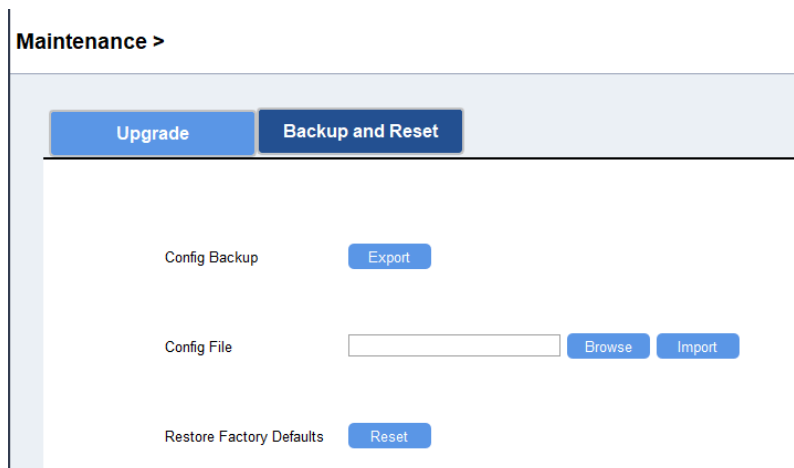

## Reset to Factory Default

**Via Hardware:** Hold on the reset button for more than 10s until the LED indicator quickly blinks.

**Via ToolBox App:** Click **Reset** and attach the smartphone to device to reset the device.

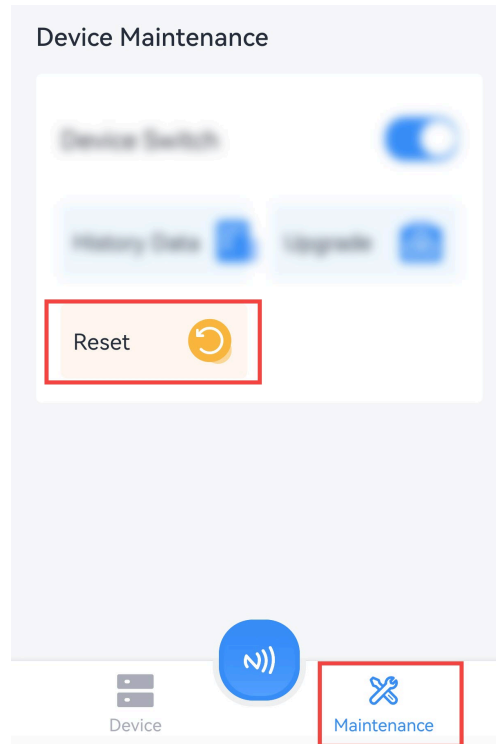

**Via ToolBox Software:** Go to **Maintenance > Backup and Reset** page, click **Reset** to reset the device.

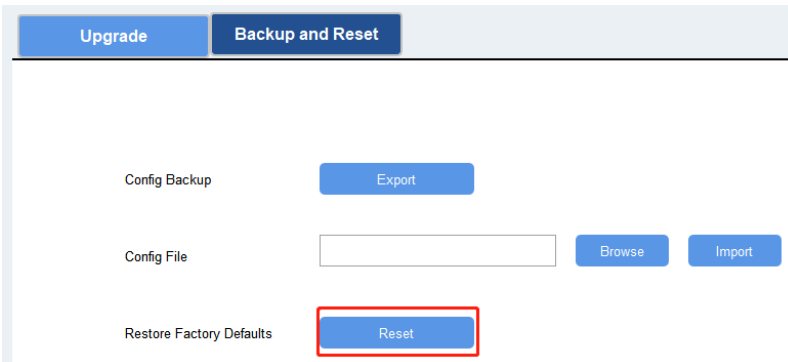

# Chapter 6. Installation

## EM500 Transceiver Installation

The transceiver supports wall, pole or DIN rail mounting.



### Note:

Keep the transceiver away from metal objects and obstacles for better signal.

### Wall Mounting

1. Drill two holes in the wall according to the mounting bracket, then secure the wall plugs into the wall.
2. Fix the mounting bracket to the wall via screws.
3. Place the device onto the mounting bracket, then secure it to the bracket with two fixing screws.

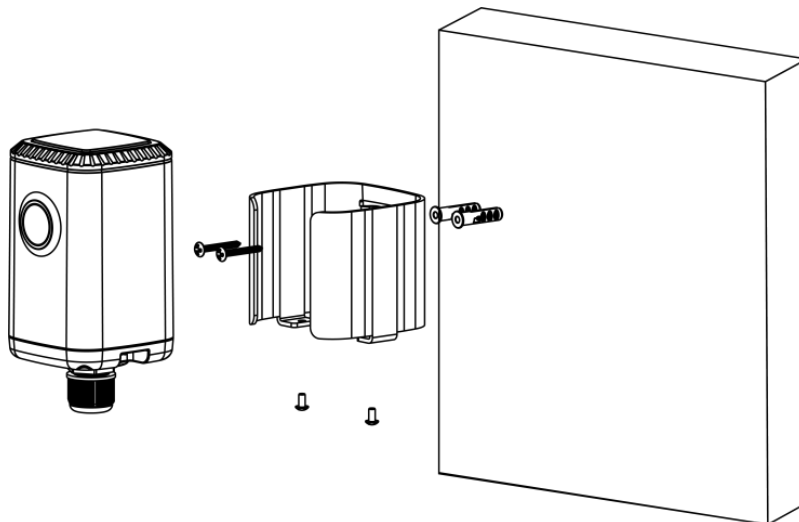

### Pole Mounting

Straighten out the hose clamp and slide it through the rectangular holes in the mounting bracket, and wrap the hose clamp around the pole. After that, use a screwdriver to tighten the locking mechanism by turning it clockwise.

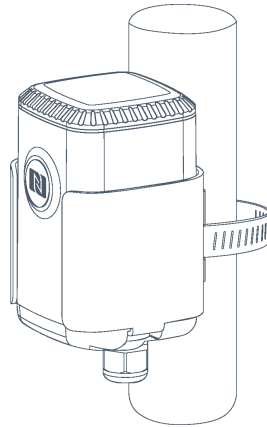
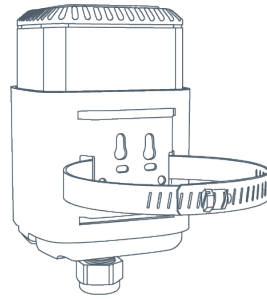

### DIN Rail Mounting

Use 2 pcs of M3 × 6 flat head Phillips screws to fix the mount clip to the bracket, and then hang the device on the DIN rail. The width of the DIN rail is 3.5 cm.

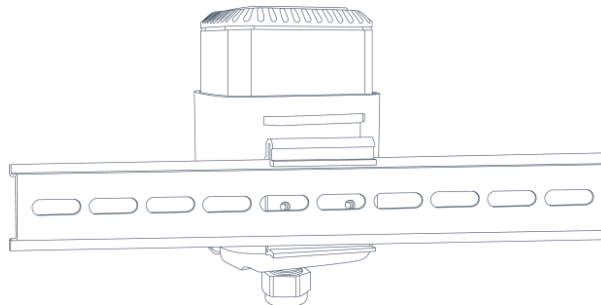
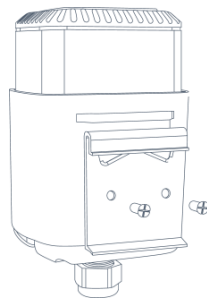

## Pipe Sensor Installation

- The selected installation position should reflect the actual situation of the measured pressure. Install the sensor in the pipe where the measuring medium flows straight and avoid the location of bends, splits, dead corners, or other places where vortices are easy to form.
- Pay attention to whether the pressure sensor is too close to the valve or pump when installing. Because the opening and closing of the valve and the start and stop of the pump will impact the diaphragm of the pressure sensor, causing diaphragm damage.
- Install the sensor in a low-vibration environment.
- Install a damper in order to prevent the pressure spikes or surges if you use EM500-PP with high-pressure hydraulic or other liquid equipment.
- When freezing occurs in winter, the pressure sensor installed outside must adopt anti-freezing measures to prevent the liquid in the pressure inlet from expanding due to icing, which may cause damage to the pressure sensor.
- When measuring steam or other high-temperature gases, add a condenser such as a buffer tube (coil), and the operating temperature of the pressure sensor should not exceed the limit.
- Do not insert a foreign object into the pressure diaphragm in an effort to simulate pressure, which may cause permanent damage.
- Clean the sensor termly in cases of high corrosion or high dust.

## Chapter 7. Battery Replacing

Remove the bottom cover to replace the battery when it has run out of power.

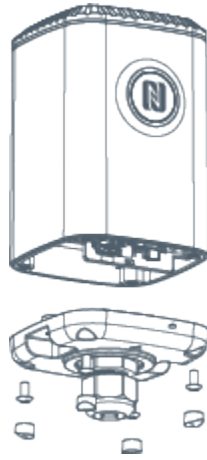

**Note:**

- The device can only be powered by the ER34615 Li-SoCl<sub>2</sub> battery. The alkaline battery is not supported.
- The battery should be removed or replaced from the device if it is not used for an extended period.
- Ensure the replacing battery is newest; otherwise, it may shorten battery life or cause inaccurate power calculations.

# Chapter 8. Uplink and Downlink

## Overview

All messages are based on following format (HEX), the Data field should follow little-endian:

Channel1	Type1	Data1	Channel2	Type2	Data2	Channel3	...
1 Byte	1 Byte	N Bytes	1 Byte	1 Byte	N Bytes	1 Byte	...

For decoder examples please find files on <https://github.com/Milesight-IoT/SensorDecoders>.

## Uplink Data

This chapter describes the reported data of the device.

Item	Channel	Type	Byte	Description
Power On	ff	0b	1	Device is on
Protocol Version	ff	01	1	Example: 01=V1
Hardware Version	ff	09	2	Example: 03 10 = V3.1
Software Version	ff	0a	2	Example: 03 01 = V3.1
Device Type	ff	0f	1	00: Class A, 01: Class B, 02: Class C, 03: Class C to B
Serial Number	ff	16	8	16 digits
Battery Level	01	75	1	UINT8, Unit: %
Pressure	03	7b	2	UINT16, Unit: kPa
Historical Data	20	ce	6	<b>Byte 1-4:</b> Data unix timestamp, UINT32, Unit: s <b>Byte 5-6:</b> Pressure, UINT16, Unit: kPa

**Note:**

- When the device fails to collect the sensor data, it will report the value as all ffff;
- When the device collects sensor data outside the measuring range, it will report the value as fffd.

**Basic Information**

The device will report a basic information packet whenever joining the network.

**Example:**

ff0bff ff0101 ff166136c40091605408 ff090200 ff0a0101 ff0f00		
Channel	Type	Value
ff	0b	Power on: ff
ff	01	Protocol version: 01=V1
ff	16	SN: 6136c40091605408
ff	09	Hardware version: 0200=V2.0
ff	0a	Software version: 0101=V1.1
ff	0f	00: Class A

**Periodic Report**

The device supports to report below types of periodic report packets.

1. Sensor data: report according to reporting interval.

037b0a00		
Channel	Type	Value
03	7b	0a 00=>00 0a=10 kPa

- Battery level: report when the device joins the network or every 24 hours.

017564		
Channel	Type	Value
01	75	Battery: 64=>100%

## Alarm Report

The device supports to report below types of alarm report packets.

- Threshold alarm or alarm dismiss. The alarm report format is the same as periodic report.

037b0a00		
Channel	Type	Value
03	7b	0a 00=>00 0a=10 kPa

- Low battery level alarm: report when battery level is below to 1%.

017501		
Channel	Type	Value
01	75	Battery: 01=>1%

## Historical Data

The device will report retransmission data or stored data as below example.

20ce 0d755b63 0a00			
Channel	Type	Time Stamp	Value
20	ce	0d 75 5b 63 => 63 5b 75 0d=1666938125s	0a 00=>00 0a=10 kPa

## Downlink Command

This chapter describes the downlink commands for device configuration and control. The downlink application port is 85 by default.

## General Setting

Item	Channel	Type	Byte	Description
Reboot	ff	10	1	ff
Collect Interval	ff	02	2	UINT16, Unit: s
Re-collect Setting	ff	1c	2	<b>Byte 1:</b> re-collect times <b>Byte 2-3:</b> re-collect interval
Report Interval	ff	03	2	UINT16, Unit: s
Data Storage	ff	68	1	00: Disable, 01: Enable
Data Retransmission	ff	69	1	00: Disable, 01: Enable
Data Retransmission Interval	ff	6a	3	<b>Byte 1:</b> 00 <b>Byte 2-3:</b> UINT16, Unit: s, Range: 30~1200, Default: 600
UTC Time Zone	ff	17	2	INT16/10
Device Time	ff	11	4	Unix timestamp, Unit: s
Sync with with LNS	ff	4a	1	ff

### Example:

1. Reboot the device.

ff10ff
--------

2. Set collect interval as 20 minutes.

ff02b004		
Channel	Type	Value
ff	02	b004=>04b0=1200s=20 minutes

3. Set report interval as 20 minutes.

ff03b004		
Channel	Type	Value
ff	03	b004=>04b0=1200s=20 minutes

4. Set time zone as UTC-2.

ff17ecff		
Channel	Type	Value
ff	17	ecff=>ff ec=-20/10=-2

### Calibration Setting

Item	Channel	Type	Byte	Description
Pressure Calibration	ff	f1	4	<b>Byte 1:</b> 03 <b>Byte 2:</b> 00-disable, 01-enable <b>Byte 3-4:</b> Calibration value, INT16, Unit: kPa

#### Examples:

1. Enable pressure calibration and set calibration value.

fff10301fdff		
Channel	Type	Value
ff	f1	03=Pressure, 01=Enable fdff=>fffd=-3 kPa

### Threshold Setting

Item	Channel	Type	Byte	Description
Pressure Threshold Alarm	ff	06	9	<b>Byte 1:</b> 08=Disable, 49=Below (min. threshold), 4a=Over (max. threshold), 4b=Within, 4c=Below or over

Item	Channel	Type	Byte	Description
				<b>Byte 2-3:</b> Minimum threshold, UINT16, Unit: kPa <b>Byte 4-5:</b> Maximum threshold, UINT16, Unit: kPa <b>Byte 6-9:</b> 00000000
Alarm Reporting Times	ff	f2	2	UINT16
Alarm Dismiss Report	ff	f5	1	00-disable, 01-enable

**Example:**

1. Set the pressure threshold as below 100 kPa.

ff0649640000000000000000		
Channel	Type	Value
ff	06	49=Below Min. threshold: 64 00=>00 64=100 kPa

**D2D Setting**

Item	Channel	Type	Byte	Description
D2D Feature	ff	84	1	00-disable, 01-enable
D2D Key	ff	35	8	The first 16 digits of D2D key, and the last 16 digits are fixed as 0.
D2D Setting	ff	96	8	<b>Byte 1:</b> 01-Pressure Threshold Triggered 02-Pressure Threshold Released <b>Byte 2:</b> 00-disable, 01-enable <b>Byte 3:</b> 00-Disable LoRa Uplink, 01-Enable LoRa Uplink <b>Byte 4-5:</b> D2D Command <b>Byte 6-8:</b> 000000

**Example:**

1. Set D2D Key as 12345678123456780000000000000000.

ff35 1234567812345678		
Channel	Type	Value
ff	35	1234567812345678

2. When the value reaches the threshold, send D2D command 0110.

ff960101001001000000		
Channel	Type	Value
ff	96	01=Threshold Triggered 01=Enable, 00=Disable LoRa uplink D2D Command: 10 01=>0110

## Historical Data Enquiry

This chapter describes data retrievability feature to send downlink command to enquire the historical data stored in the device. Before that, ensure the device time is correct and data storage feature was enabled to store data.

**Command Format:**

Item	Channel	Type	Byte	Description
Enquire Data in Time Point	fd	6b	4	Unix timestamp, Unit: s
Enquire Data in Time Range	fd	6c	8	Byte 1-4: Start timestamp, Unit: s Byte 5-8: End timestamp, Unit: s
Stop Query Data Report	fd	6d	1	ff
Data Retrieval Interval	ff	6a	3	Byte 1: 01

Item	Channel	Type	Byte	Description
				Byte 2-3: UINT16, Unit: s, Range: 30~1200, Default: 60

**Reply Format:**

Item	Channel	Type	Byte	Description
Enquiry Result	fc	6b/6c	1	00: Enquiry success. The device will report the historical data according to data retrievability interval. 01: Time point or time range invalid 02: No data in this time or time range

**Note:**

1. Use [Unix Timestamp Converter](#) to calculate the time.
2. The device only uploads no more than 300 data records per range enquiry.
3. When enquiring the data in time point, it will upload the data which is closest to the search point within the reporting interval range. For example, if the device's reporting interval is 10 minutes and users send command to search for 17:00's data, if the device find there is data stored in 17:00, it will upload this data; if not, it will search for data between 16:50 to 17:10 and upload the data which is closest to 17:00.

**Example:**

Enquire the historical data in a time range.

fd6c 64735b63 7c885b63		
Channel	Type	Value
fd	6c	Start time: 64 73 5b 63 => 63 5b 73 64 = 1666937700s End time: 7c 88 5b 63 => 63 5b 88 7c = 1666943100s

Reply:

fc6c00		
Channel	Type	Value
fc	6c	00: Enquiry success

20ce 0d755b63 0a00			
Channel	Type	Time Stamp	Value
20	ce	0d 75 5b 63 => 63 5b 75 0d=1666938125s	0a 00=>00 0a=10 kPa

## Chapter 9. Services

Milesight provides customers with timely and comprehensive technical support services. End-users can contact your local dealer to obtain technical support. Distributors and resellers can contact directly with Milesight for technical support.

Technical Support Mailbox: [iot.support@milesight.com](mailto:iot.support@milesight.com)

Online Support Portal: <https://support.milesight-iot.com>

Resource Download Center: <https://www.milesight.com/iot/resources/download-center/>

### **MILESIGHT CHINA**

TEL: +86-592-5085280

FAX: +86-592-5023065

Add: Building C09, Software Park Phase III, Xiamen 361024, Fujian, China