

# Mini Industrial Router

## UR41(L)

### User Guide



## Safety Precautions Preface

Milesight will not shoulder responsibility for any loss or damage resulting from not following the instructions of this operating guide.

- ❖ The device must not be disassembled or remodeled in any way.
- ❖ To avoid risk of fire and electric shock, do keep the product away from rain and moisture before installation.
- ❖ Do not place the device where the temperature or humidity is below/above the operating range.
- ❖ The device must never be subjected to drops, shocks or impacts.
- ❖ Make sure the device is firmly fixed when installing.
- ❖ Make sure the plug is firmly inserted into the power socket.
- ❖ Do not pull the antenna or power supply cable, detach them by holding the connectors.
- ❖ Do not power on the device or connect it to other electrical device when installing.
- ❖ Do not connect or power the device using cables that have been damaged.

© 2011-2026 Xiamen Milesight IoT Co., Ltd.

**All rights reserved.**

All information in this user guide is protected by copyright law. Whereby, no organization or individual shall copy or reproduce the whole or part of this user guide by any means without written authorization from Xiamen Milesight IoT Co., Ltd.

## Declaration of Conformity

UR41(L) is in conformity with the essential requirements and other relevant provisions of the CE, FCC, and RoHS.

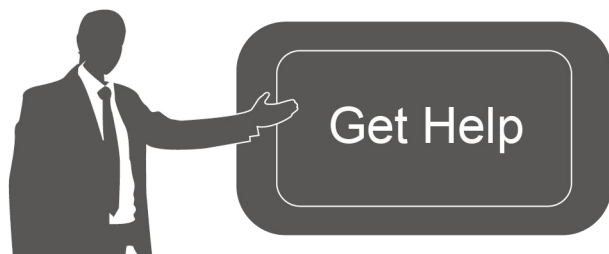

For assistance, please contact

Milesight technical support:

Email: [iot.support@milesight.com](mailto:iot.support@milesight.com)

Support Portal: [support.milesight-iot.com](http://support.milesight-iot.com)

Tel: 86-592-5085280

Fax: 86-592-5023065

Address: Building C09, Software Park III,  
Xiamen 361024, China

## Revision History

Date	Doc Version	Description
Feb. 8, 2023	V 1.0	Initial version
Sept. 5, 2023	V 1.1	<ol style="list-style-type: none"> <li>1. Add MQTT and TR069 feature;</li> <li>2. Support customized cellular MTU and IMS;</li> <li>3. Support to import openVPN file configurations, add tls-crypt mode and authentication mode;</li> <li>4. Update Modbus Master/Slave to Modbus Client/Server;</li> <li>5. Support to configure L2TP hostname.</li> </ol>
July 29, 2024	V1.2	<ol style="list-style-type: none"> <li>1. Add UR41L model;</li> <li>2. Add DIN rail mounting installation.</li> </ol>
Sep.19, 2025	V1.3	<ol style="list-style-type: none"> <li>1. Compatible with Milesight Development Platform;</li> <li>2. Add ZeroTier and WireGuard VPN feature;</li> <li>3. Add cellular custom DNS server option;</li> <li>4. Support MQTT feature on DI and serial DTU mode downlink;</li> <li>5. Support to sync time with cellular operator;</li> <li>6. Add cellular band selection and subnet mask customization;</li> <li>7. Add DLMS feature;</li> <li>8. Support cellular interface IP passthrough;</li> <li>9. Support multiple APN;</li> <li>10. Support policy routing function;</li> <li>11. Support to configure IP and reporting interval in DDNS settings;</li> <li>12. Support multiple local &amp; remote subnets on IPsec;</li> <li>13. Add byte order option on Modbus channel settings.</li> </ol>
Dec. 30, 2025	V1.4	<ol style="list-style-type: none"> <li>1. Modbus Client function optimization.</li> <li>2. Add web password limitation and change prompt.</li> <li>3. Add partial backup.</li> <li>4. Add auto APN.</li> <li>5. Add level change trigger mode and SNMP Trap reporting in DI setting.</li> <li>6. Add Autp DST function in system time setting.</li> <li>7. Support automatic IP address acquisition via interface in DMVPN setting.</li> <li>8. Add multiple encryption and authentication algorithms for DMVPN.</li> </ol>

# Contents

Chapter 1 Product Introduction .....	8
1.1 Overview .....	8
1.2 Advantages .....	8
Chapter 2 Hardware Introduction .....	9
2.1 Packing List .....	9
2.2 Hardware Overview .....	10
2.3 Serial & IO & Power .....	10
2.4 LED Indicators .....	11
2.5 Reset Button .....	11
2.6 Dimensions (mm) .....	12
Chapter 3 Hardware Installation .....	12
3.1 SIM Card Installation .....	12
3.2 Antenna Installation .....	12
3.3 Router Installation .....	13
Chapter 4 Access to Web GUI .....	14
Chapter 5 Web Configuration .....	16
5.1 Status .....	16
5.1.1 Overview .....	16
5.1.2 Cellular .....	17
5.1.3 Network .....	18
5.1.4 VPN .....	19
5.1.5 Routing .....	20
5.1.6 Host List .....	20
5.1.7 GPS (UR41 Only) .....	21
5.2 Network .....	21
5.2.1 Interface .....	21
5.2.1.1 Cellular .....	21
5.2.1.2 Port .....	25
5.2.1.3 USB .....	25
5.2.1.4 Bridge .....	26
5.2.1.5 Loopback .....	26
5.2.2 DHCP .....	27
5.2.2.1 DHCP Server/DHCPv6 Server .....	27
5.2.2.2 DHCP Relay .....	29
5.2.3 Firewall .....	30
5.2.3.1 Security .....	31
5.2.3.2 ACL .....	32
5.2.3.3 Port Mapping .....	33
5.2.3.4 DMZ .....	34
5.2.3.5 MAC Binding .....	34
5.2.3.6 Custom Rules .....	34

5.2.3.7 SPI .....	35
5.2.4 QoS .....	36
5.2.5 VPN .....	37
5.2.5.1 DMVPN .....	37
5.2.5.2 IPsec Server .....	39
5.2.5.3 IPsec .....	42
5.2.5.4 GRE .....	45
5.2.5.5 L2TP .....	46
5.2.5.6 PPTP .....	48
5.2.5.7 OpenVPN Client .....	50
5.2.5.8 OpenVPN Server .....	52
5.2.5.9 Certifications .....	55
5.2.5.10 WireGuard .....	56
5.2.5.11 ZeroTier .....	58
5.2.6 IP Passthrough .....	59
5.2.7 Routing .....	59
5.2.7.1 Static Routing .....	59
5.2.7.2 Priority Based Routing .....	60
5.2.7.3 RIP .....	61
5.2.7.4 OSPF .....	64
5.2.7.5 Routing Filtering .....	69
5.2.8 VRRP .....	70
5.2.9 DDNS .....	72
5.3 System .....	73
5.3.1 General Settings .....	73
5.3.1.1 General .....	73
5.3.1.2 System Time .....	74
5.3.1.3 Email .....	75
5.3.2 Phone&SMS .....	76
5.3.2.1 Phone .....	76
5.3.2.2 SMS .....	77
5.3.3 Power Management .....	79
5.3.4 User Management .....	81
5.3.4.1 Account .....	81
5.3.4.2 User Management .....	82
5.3.5 AAA .....	82
5.3.5.1 Radius .....	82
5.3.5.2 TACACS+ .....	83
5.3.5.3 LDAP .....	84
5.3.5.4 Authentication .....	84
5.3.6 Device Management .....	85
5.3.6.1 Auto Provision .....	85
5.3.6.2 DeviceHub .....	85
5.3.6.3 Milesight VPN .....	86

5.3.7 Events .....	87
5.3.7.1 Events .....	87
5.3.7.2 Events Settings .....	87
5.4 Service .....	90
5.4.1 I/O .....	90
5.4.1.1 DI .....	90
5.4.1.2 DO .....	91
5.4.2 Serial Port .....	91
5.4.3 Modbus Server (Slave) .....	95
5.4.3.1 Modbus TCP .....	95
5.4.3.2 Modbus RTU .....	96
5.4.3.3 Modbus RTU Over TCP .....	96
5.4.4 Modbus Client (Master) .....	97
5.4.4.1 Modbus Client .....	97
5.4.4.2 Channel Settings .....	98
5.4.4.3 Alarm Settings .....	100
5.4.4.4 Data Forwarding .....	102
5.4.5 GPS (UR41 Only) .....	103
5.4.5.1 GPS IP Forwarding .....	103
5.4.5.2 GPS Serial Forwarding .....	105
5.4.5.3 GPS MQTT Forward .....	106
5.4.6 MQTT .....	106
5.4.7 SNMP .....	110
5.4.7.1 SNMP .....	110
5.4.7.2 MIB View .....	111
5.4.7.3 VACM .....	111
5.4.7.4 Trap .....	112
5.4.7.5 MIB .....	113
5.4.8 TR069 .....	113
5.4.9 DLMS .....	114
5.4.9.1 Physical Device Settings .....	114
5.4.9.2 COSEM Group Settings .....	116
5.4.9.3 Platform Connection Settings .....	118
5.5 Maintenance .....	119
5.5.1 Tools .....	119
5.5.1.1 Ping .....	119
5.5.1.2 Traceroute .....	120
5.5.1.3 Packet Analyzer .....	120
5.5.1.4 Qxdmlog .....	121
5.5.2 Debugger .....	121
5.5.2.1 Cellular Debugger .....	121
5.5.2.2 Firewall Debugger .....	122
5.5.3 Log .....	122
5.5.3.1 System Log .....	122

5.5.3.2 Log Download .....	123
5.5.3.3 Log Settings .....	124
5.5.4 Upgrade .....	124
5.5.5 Backup and Restore .....	125
5.5.6 Reboot .....	126
Chapter 6 Application Examples .....	127
6.1 Cellular Connection .....	127
6.2 OpenVPN Client Application Example .....	128
6.3 NAT Application Example .....	130
6.4 DTU Application Example .....	130
6.5 Restore Factory Defaults .....	134
6.6 Firmware Upgrade .....	135
6.7 SNMP Application Example .....	135
6.8 QoS Application Example .....	138
6.9 DLMS Client Example .....	139

## Chapter 1 Product Introduction

### 1.1 Overview

Milesight mini industrial router UR41(L) supports 4G connection, and also satisfies multi-type local data access requirements through rich industrial interfaces, including DI, DO, RS232 or RS485. UR41(L) make it easy for forming a reliable, secure, and maintainable solution through its built-in watchdog and secure VPN tunnels, realizing stable data transmission and high-speed mobile connectivity.

With a compact size and industry-grade design, UR41(L) is more flexible in a variety of installation and deployment scenarios. UR41(L) adopts a power-saving design with both idle mode and standby mode for providing users with an energy-saving option. UR41(L) could be managed and monitored remotely by Milesight DeviceHub and Development Platform, UR41(L) could be applied in wide scenarios including vending machines, robots, industrial equipment, and other IoT applications with optimal cost and performance.

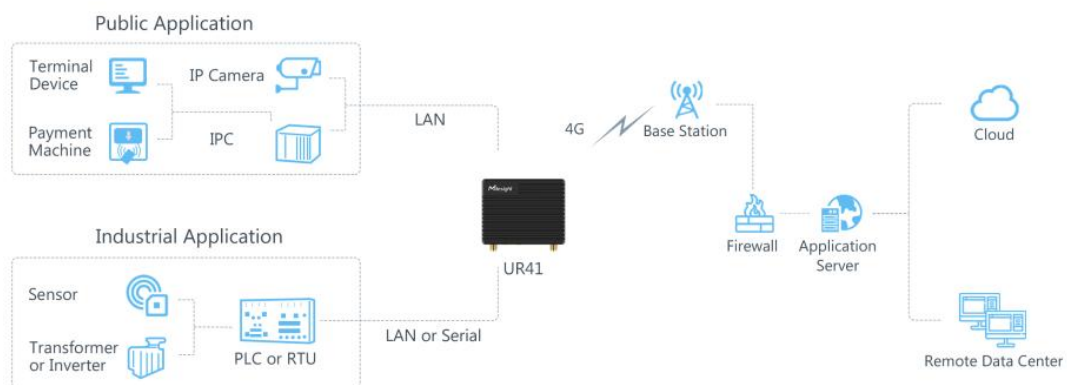

### 1.2 Advantages

#### Highlight Features

- Compact size for suiting small embedded scenarios
- Global 4G LTE/3G network with multiple carrier networks
- Multiple APN interfaces for simultaneous access to different network services
- Easy to connect with diverse wired devices through DI/DO/RS232/RS485 interfaces
- Power-saving design for both idle mode and standby mode for providing users with an energy-saving option

#### Industrial-Grade Design

- NXP industrial grade processor
- Rugged enclosure with IP30 protection
- Desk, wall or DIN rail mounting

- Wide operating temperature range from -40°C to 60°C/-40 °F to + 140°F

### Easy Maintenance

- Milesight DeviceHub/Development Platform provides easy setup, mass configuration, and centralized management of remote devices
- The user-friendly web interface design and more than one option of upgrade help administrators to manage the device as easy as pie
- WEB GUI and CLI enable the admin to achieve simple management and quick configuration among a large quantity of devices
- Efficiently manage the remote routers on the existing platform through the industrial standard SNMP and TR069

### Security & Reliability

- Secure transmission with VPN tunnels like IPsec/OpenVPN/GRE/L2TP/PPTP/DMVPN/ZeroTier
- Embeds hardware watchdog to automatically recover from various failures, ensuring highest level of availability
- Support access control lists, DMZ, DDoS Protection, Filters, SPI firewalls
- Establishes a secured mechanism on centralized authentication and authorization of device accessed by supporting AAA (Radius, TACACS+, LDAP, local Authentication) and multiple levels of user authority

## Chapter 2 Hardware Introduction

### 2.1 Packing List

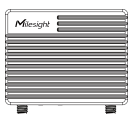

1 × UR41(L) Device

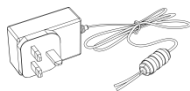

1 × Power Adapter



1 × 8-Pin Pluggable  
Terminal



1 × SIM Card Ejector Tool

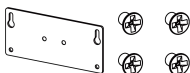

1 × Wall Mounting  
Bracket with  
Screws

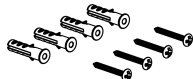

4 × Wall Mounting  
Kits



1 × Warranty Card



1 × Quick Start Guide



1 × Magnetic Cellular Antenna

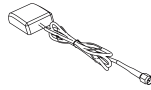

1 × GPS Antenna (UR41 Only)



1 × 108mm Stubby Cellular Antenna (Optional)



1 × Mini Stubby Cellular Antenna (Optional)



1 × USB 2.0 Cable (Optional)



1 × DIN Rail Kit (Optional)



If any of the above items is missing or damaged, please contact your sales representative.

## 2.2 Hardware Overview

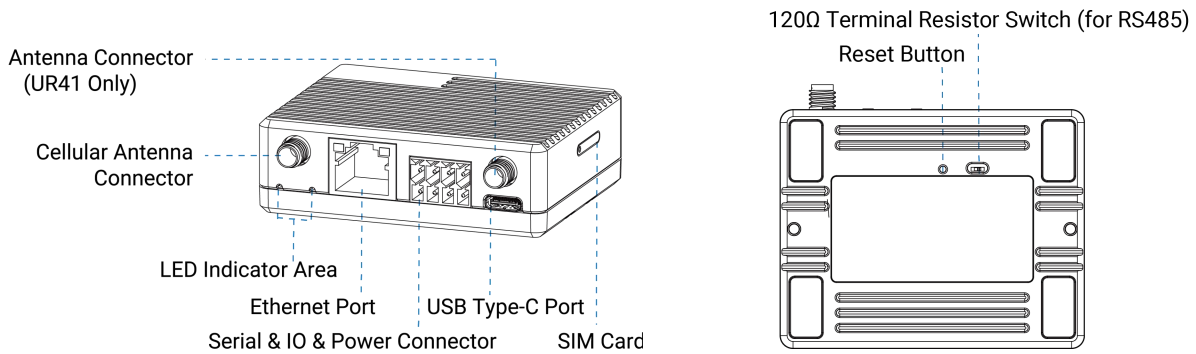

**120Ω Terminal Resistor Switch:** the device will add a 120Ω termination resistor to avoid data-corrupting reflections if RS485 data rate is too high or cable length is too long.

## 2.3 Serial & IO & Power

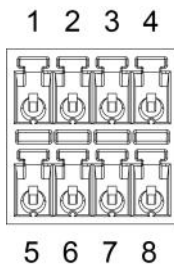

PIN	RS232 /RS485	DI	DO	Power	Description
1	---	---	OUT	---	Digital Output
2	---	IN	---	---	Digital Input
3	TX/A	---	---	---	Transmit Data
4	---	---	---	DC+	Positive
5	---	---	COM	---	Common Ground
6	GND	GND	---	---	Ground
7	RX/B	---	---	---	Receive Data
8	---	---	---	DC-	Negative

## 2.4 LED Indicators

LED	Indication	Status	Description
SYSTEM	Power & System Status	Off	The power is switched off
		Orange	Static: the power is switched on, the system is on standby mode
			Blinking three times: the power is switched on, the system is starting up
		Green	Static: The system is running properly
		Red	Static: The system goes wrong
LTE	Cellular & Signal Status	Off	SIM card is registering or fails to register (or there are no SIM cards inserted)
		Green	Blinking rapidly: SIM card has been registered and is dialing up now
			Static: SIM card has been registered and dialed up to 4G network
Orange	Static: SIM card has been registered and dialed up to 3G/2G network		
Ethernet Port	Link Indicator (Orange)	Off	Disconnected or fail to connect
		On	Connected
		Blinking	Transmitting data
	Rate Indicator (Green)	Off	10 Mbps mode
		On	100 Mbps mode

**Note:** It will take around 1 minute for UR41(L) to completely start up, then the SYSTEM light will be green.

## 2.5 Reset Button

Function	Description	
	SYSTEM LED	Action
Reset	Static	Press and hold the reset button for more than 5 seconds.
	Static → Blinking	Release the button and wait.
	Off → Static Green	The router is now reset to factory defaults.
Weakup	Orange Static → Green Static	If standby mode is enabled, press and hold on reset button for 3 seconds to weak up the router for 1 hour.

## 2.6 Dimensions (mm)

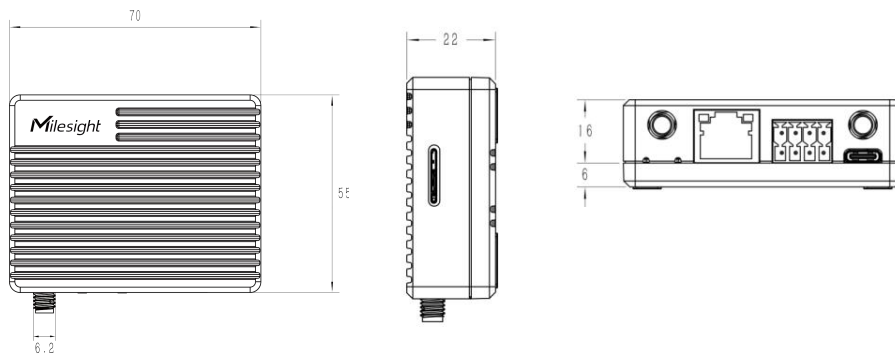

## Chapter 3 Hardware Installation

### 3.1 SIM Card Installation

Use an ejector tool to open the SIM card slot, insert the nano SIM card, then put the slot with SIM card back to the device.

**Note:** UR41(L) does not support hot plugging (also called hot swapping). please turn off the power before you insert or take off cards.

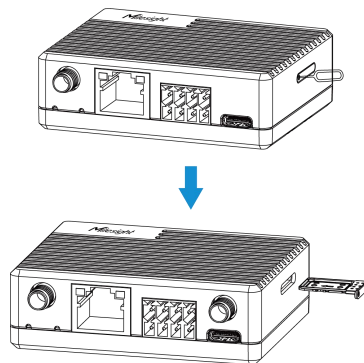

### 3.2 Antenna Installation

Rotate the antenna into the antenna connector accordingly. The external antenna should be installed vertically, and always on a site with a good signal.

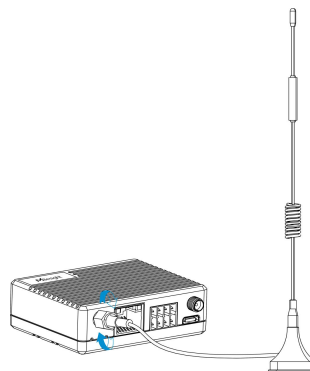

### 3.3 Router Installation

UR41(L) router can be mounted to a wall or a DIN rail. Before you start, make sure that a SIM card has been inserted, antennas have been attached and all cables have been installed.

#### Wall Mounting

1. Fix the wall mounting bracket to the device with 2 screws.

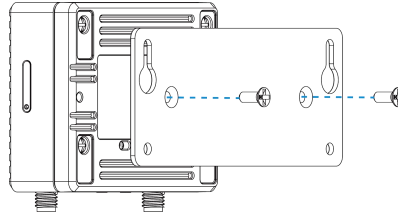

2. Drill 4 holes on the wall according to wall mounting bracket, then fix the wall plugs to the wall.
3. Fix the device to the wall plugs with screws. When installing, it's suggested to fix the upper two screws first.

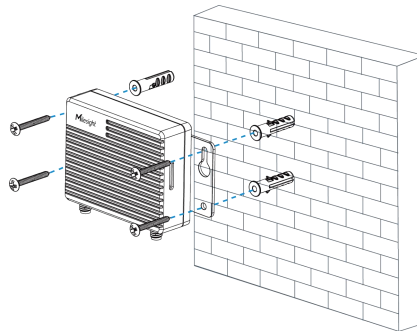

#### DIN Rail Mounting

Use 2 pcs of M3 × 6 flat head Phillips screws to fix the mount clip to the router, and then hang the device to the DIN rail. The width of DIN rail is 3.5 cm.

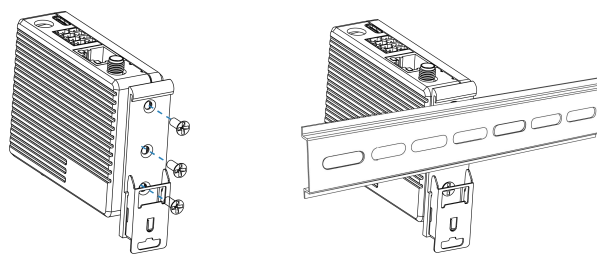

## Chapter 4 Access to Web GUI

This chapter explains how to access to Web GUI of the router. Connect PC to LAN port of the router directly. The following steps are based on Windows 10 operating system for your reference.

Username: **admin**

Password: **password**

IP Address: **192.168.1.1**

1. Go to "Control Panel" → "Network and Internet" → "Network and Sharing Center", then click "Ethernet" (May have different names).

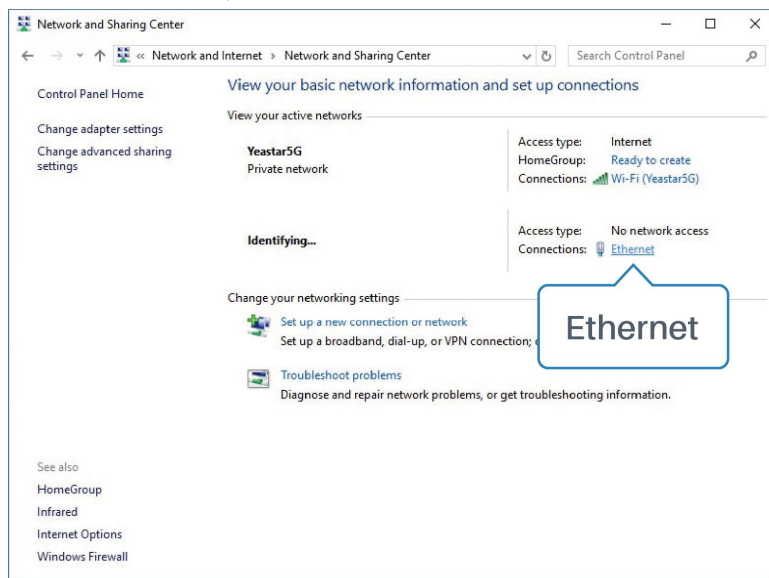

2. Go to "Properties" → "Internet Protocol Version 4(TCP/IPv4) ", select "Obtain an IP address automatically" or "Use the following IP address", then assign a static IP manually within the same subnet of the device.

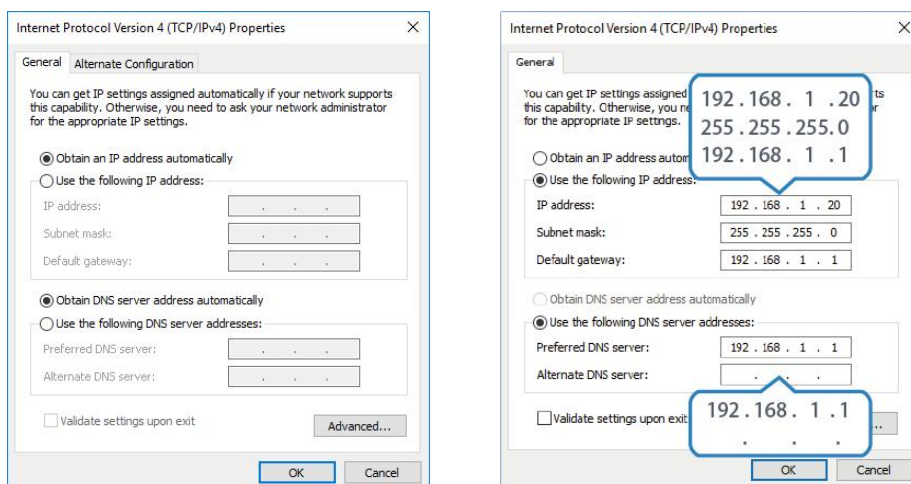

3. Open a Web browser on your PC (Chrome is recommended), type in the IP address <https://192.168.1.1>, and press Enter on your keyboard.
4. Enter the username, password, and click "Login".

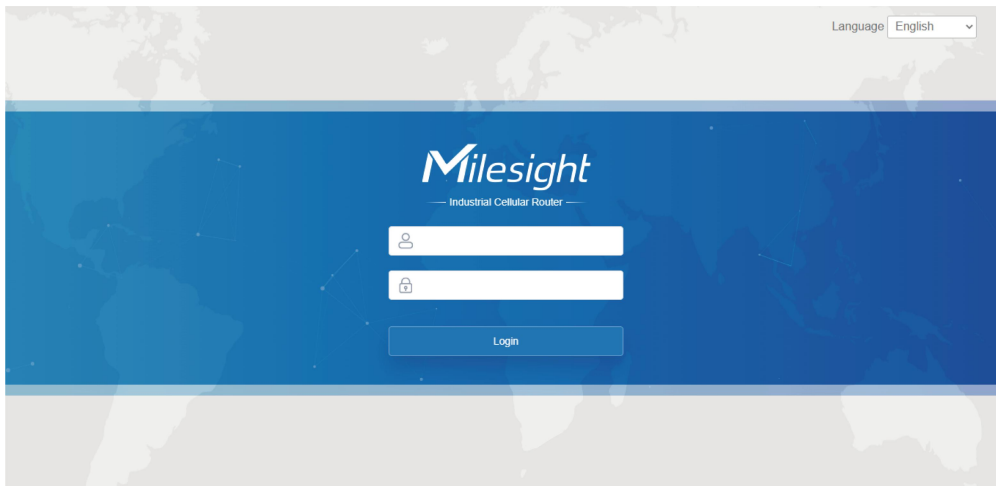

**!** If you enter the username or password incorrectly more than 5 times, the login page will be locked for 10 minutes.

5. After logging the web GUI, it is necessary to change the web GUI password for the first time. The password must contain at least one letter and one number.

**Please change the initial password** ✕

Old Password

New Password

Confirm New Password

6. Use the new password to log in to the web GUI again. After logging the web GUI, you can view system information.

## Chapter 5 Web Configuration

### 5.1 Status

#### 5.1.1 Overview

You can view the system information of the router on this page. The information displayed may appear slightly different, as the UR41L is not equipped with multiple APN functionality. For UPS items please refer to ***Milesight UPS User Guide***.

Overview	Cellular	Network	VPN	Routing	Host List	GPS	
System Information				System Status			
Model		UR41-L08EU-G		Local Time	2025-09-19 04:45:35 Friday		
Serial Number		6053C5280608		Uptime	00:02:39		
Firmware Version		41.0.0.5		CPU Load	39%		
Hardware Version		V2.0		CPU Temperature	48°C		
Cellular				RAM (Available/Capacity)			87MB/128MB(67.97%)
Status		No SIM Card, 		Flash (Available/Capacity)			84MB/128MB(65.63%)
Current Cellular Link		-		LAN			
IPv4		-		IPv4	192.168.1.1/24		
IPv6		-		IPv6	fe80::26e1:24ff:fe6:9683/64		
Connection Duration		-		Connected Devices	1		
SIM Data Usage Monthly		0.0 MiB					
UPS							
Model		-					
Serial Number		-					
Firmware Version		-					
Hardware Version		-					
Power Status		Unconnected					
Remaining Battery		-					
Battery Temperature		-					

System Information	
Item	Description
Model	Show the model name of router.
Serial Number	Show the serial number of router.
Firmware Version	Show the currently firmware version of router.
Hardware Version	Show the currently hardware version of router.

System Status	
Item	Description
Local Time	Show the currently local time of system.
Uptime	Show the information on how long the router has been running.
CPU Load	Show the current CPU utilization of the router.
CPU Temperature	Show current CPU temperature.

RAM (Available/Capacity)	Show the RAM capacity and the available RAM memory.
Flash (Available/Capacity)	Show the Flash capacity and the available Flash memory.

Cellular	
Item	Description
Status	Show the real-time status of the currently SIM card
Current Cellular Link	Show the cellular network currently used for the data connection.
IPv4	Show the IPv4 address obtained from the mobile carrier.
IPv6	Show the IPv6 address obtained from the mobile carrier (LOGEU version is not support).
Connection Duration	Show the connection duration of the currently SIM card.
SIM Data Usage Monthly	Show the monthly data usage statistics of currently used SIM card.

LAN	
Item	Description
IP4/IPv6	Show the IP4/IPv6 address of the LAN port.
Connected Devices	Number of devices that connected to the router's LAN.

### 5.1.2 Cellular

You can view the cellular network status of router on this page. The information displayed may appear slightly different, as the UR41L is not equipped with multiple APN functionality.

Overview	Cellular	Network	VPN	Routing	Host List	GPS
<b>Modem</b>		<b>SIM1-APN1</b>				
Model	EG95	Status	Disconnected			
Version	EG95EXGAR08A08M1G_20.201.20.201	IPv4 Address	0.0.0.0/0			
Signal Level	18asu (-77dBm)	IPv4 Gateway	0.0.0.0			
Register Status	Not registered	IPv4 DNS	0.0.0.0			
IMEI	864004047548802	IPv6 Address	::			
IMSI	-	IPv6 Gateway	::			
ICCID	-	IPv6 DNS	::			
ISP	-	Connection Duration	0 days, 00:00:00			
Network Type	-	<b>SIM1-APN2</b>				
Cellular Frequency Band	-	Status	Disconnected			
PLMN ID	-	IPv4 Address	0.0.0.0/0			
LAC	-	IPv4 Gateway	0.0.0.0			
Cell ID	-	IPv4 DNS	0.0.0.0			
RSRP	-107dbm	IPv6 Address	::			
RSRQ	-	IPv6 Gateway	::			
SINR	-	IPv6 DNS	::			
<b>Data Usage Monthly</b>		Connection Duration	0 days, 00:00:00			
RX	0.0 MiB	<b>SIM1-APN3</b>				
TX	0.0 MiB	Status	Disconnected			
ALL	0.0 MiB	IPv4 Address	0.0.0.0/0			
		IPv4 Gateway	0.0.0.0			

Modem Information	
Item	Description
Model	Show the model name of cellular module.
Version	Show the cellular module firmware version.
Signal Level	Show the cellular signal level.
Register Status	Show the registration status of SIM card.
IMEI	Show the IMEI of the module.
IMSI	Show IMSI of the SIM card.
ICCID	Show ICCID of the SIM card.
ISP	Show the network provider which the SIM card registers on.
Network Type	Show the connected network type, such as LTE, 3G, etc.
PLMN ID	Show the current PLMN ID, including MCC, MNC, LAC and Cell ID.
LAC	Show the location area code of the SIM card.
Cell ID	Show the Cell ID of the SIM card location.

SIM-APN/Network	
Item	Description
Status	Show the connection status of cellular network.
IPv4/IPv6 Address	Show the IPv4/IPv6 address and netmask of cellular network.
IPv4/IPv6 Gateway	Show the IPv4/IPv6 gateway and netmask of cellular network.
IPv4/IPv6 DNS	Show the IPv4/IPv6 DNS of cellular network.
Connection Duration	Show information on how long the cellular network has been connected.

Data Usage Monthly	
Item	Description
RX	Show the data volume and packets received of this month.
TX	Show the data volume and packets transmitted of this month.
ALL	Show the total volume and packets of this month.

### 5.1.3 Network

On this page you can check the Bridge status of the router.

Bridge				
Name	STP	IPv4	IPv6	Members
Bridge0	Disabled	192.168.43.181/24	-	eth0,usb0

Bridge	
Item	Description
Name	Show the name of the bridge interface.
STP	Show if STP is enabled.

IPv4/IPv6	Show the IPv4/IPv6 address and netmask of the bridge interface.
Members	Show the members of the bridge interface.

### 5.1.4 VPN

You can check VPN status on this page, including PPTP, L2TP, IPsec, OpenVPN and DMVPN.

Overview	Cellular	Network	VPN	Routing	Host List	GPS
<b>Clients</b>						
Name	Status	Local IP	Remote IP			
<b>Server</b>						
Name	Status					
OpenVPN Server	Disabled					
Ipssec Server	Disabled					
<b>Connected List</b>						
Server Type	Client IP	Duration				

VPN Status	
Item	Description
<b>Clients</b>	
Name	Show the name of the enabled VPN clients.
Status	Show the status of client. "Connected" refers to a status that client is connected to the server. "Disconnected" means client is disconnected to the server.
Local IP	Show the local IP address of the tunnel.
Remote IP	Show the real remote IP address of the tunnel.
<b>Server</b>	
Name	Show the name of the enabled VPN Server.
Status	Show the status of Server.
<b>Connected List</b>	
Server Type	Show the type of the server.
Client IP	Show the IP address of the client which connected to the server.
Duration	Show the information about how long the client has been connected to this server when the server is enabled. Once the server is disabled or connection is disconnected, the duration will stop counting.

## 5.1.5 Routing

You can check routing status on this page, including the routing table and ARP cache.

Routing Table					
Destination	Netmask/Prefix Length	Gateway	Interface	Metric	
127.0.0.0	255.0.0.0	-	Loopback	-	
192.168.0.0	255.255.0.0	192.168.43.1	Bridge0	1	
192.168.43.0	255.255.255.0	-	Bridge0	-	
:::1	128	-	Loopback	-	

ARP Cache		
IP	MAC	Interface
192.168.43.1	b8:e3:b1:90:fd:0e	Bridge0

Item	Description
<b>Routing Table</b>	
Destination	Show the IP address of destination host or destination network.
Netmask/Prefix Length	Show the netmask or prefix length of destination host or destination network.
Gateway	Show the IP address of the gateway.
Interface	Show the outbound interface of the route.
Metric	Show the metric of the route.
<b>ARP Cache</b>	
IP	Show the IP address of ARP pool.
MAC	Show the IP address's corresponding MAC address.
Interface	Show the binding interface of ARP.

## 5.1.6 Host List

You can view the host information on this page.

Overview	Cellular	Network	VPN	Routing	Host List
DHCP Leases					
IP		MAC/DUID		Lease Remaining Time	
MAC Binding					
IP		MAC/DUID			

Host List	
Item	Description
<b>DHCP Leases</b>	
IP Address	Show IP address of DHCP client
MAC/DUID	Show MAC address of DHCPv4 client or DUID of DHCPv6 client.
Lease Time Remaining	Show the remaining lease time of DHCP client.

**MAC Binding**

IP &amp; MAC

Show the IP address and MAC address set in the Static IP list of DHCP service.

**5.1.7 GPS (UR41 Only)**

When GPS function is enabled and the GPS information is obtained successfully, you can view the latest GPS information including GPS Time, Latitude, Longitude and Speed on this page.

GPS Status	
Status	Weak Signal
Time for Locating	-
Satellites In Use	-
Satellites In View	-
Latitude	-
Longitude	-
Altitude	-
Speed	-

GPS Status	
Item	Description
Status	Show the status of GPS.
Time for Locating	Show the time for locating.
Satellites In Use	Show the quantity of satellites in use.
Satellites In View	Show the quantity of satellites in view.
Latitude	Show the Latitude of the location.
Longitude	Show the Longitude of the location.
Altitude	Show the Altitude of the location.
Speed	Show the speed of movement.

**5.2 Network****5.2.1 Interface****5.2.1.1 Cellular**

This section explains how to set the related parameters for cellular network. The UR41 features a single cellular interface, it is fixed to create 3 sub-cellular network interfaces, each supporting the configuration of one APN. The three sub-cellular network interfaces can be active at one time,

enabling different network services to be accessed simultaneously through multiple APNs when the cellular network is registered. **For UR41L model, the cellular interface only supports SIM1-APN1.**

**Note:**

- Do not only use computer to supply power to device, otherwise there is not enough power for device to register to cellular network.
- To use the multi-APN feature for the first time, a device reboot is required.
- After enabling multi-APN, different sub-interfaces on the same SIM card cannot add the same APN.

SIM1
SIM Setting

Interface Name	Status	Network Type	IP	APN	Enable Status	Operation
SIM1-APN1	Connect Failed	Auto	-	-	<input checked="" type="checkbox"/>	
SIM1-APN2	-	Auto	-	-	<input type="checkbox"/>	
SIM1-APN3	-	Auto	-	-	<input type="checkbox"/>	

**Connection Setting**

Connection Mode: Connect on Demand v

Re-dial Interval(s): 5

Max Idle Time(s): 60

Triggered by Call:

Call Group:   v

Triggered by SMS:

SMS Group:   v

SMS Text:  

Triggered by IO:

Emergency Reboot:

Cellular Setting	
Item	Description
Interface Name	Display cellular network interface names.
Status	Show the cellular network connection status.
Network Type	Select from "Auto", "4G Only", "3G Only", and "2G Only". Auto: connect to the network with the strongest signal automatically. 4G Only: connect to 4G network only. And so on.
IP	IP address corresponding to this cellular network interface.
APN	APN name corresponding to this cellular network interface.
Enable Status	Show the enable status of this interface.
Operation	You can edit the configuration items for this cellular network interface.
Connection Setting	
Item	Description

Connection Mode	Select "Always Online" and "Connect on Demand".
Re-dial Interval(s)	Set the interval to dial into ISP when it loses connection. The default value is 5s.
Emergency Reboot	Enable to reboot the device if no link is available.
Max Idle Times	Set the maximum duration of the router when the current link is under idle status. Range: 10-3600
Triggered by Call	The router will automatically switch from offline mode to cellular network mode upon receiving a call from a specific phone number.
Call Group	Select a call group for the call trigger. Go to <b>System &gt; Phone&amp;SMS &gt; Phone</b> to set up phone group.
Triggered by SMS	The router will switch from offline mode to cellular network mode automatically when it receives a specific SMS from the specific mobile phone.
SMS Group	Select an SMS group for the trigger. Go to <b>System &gt; Phone&amp;SMS &gt; SMS</b> to set up an SMS group.
SMS Text	Fill in the SMS content for triggering.

**SIM Setting**

PIN Code

Access Number

Network Type

Cellular Frequency Band

IMS Enable

SMS Center

Roaming

IPv4 Subnet Mask

Data Limit  MB

Billing Day Day  of The Month

SIM Setting	
Item	Description
PIN Code	Enter a 4-8 characters PIN code to unlock the SIM.
Access Number	Enter the dial-up center NO. For cellular dial-up connection provided by local ISP.
Network Type	Select from "Auto", "4G Only", "3G Only", and "2G Only". Auto: connect to the network with the strongest signal automatically. 4G Only: connect to 4G network only. And so on.
Cellular Frequency Band	Select the cellular bands used to register the cellular network. It can be used to optimize cellular speeds by selecting specific bands.
IMS Enable	Enable or disable IMS function.

SMS Center	Enter the local SMS center number for storing, forwarding, converting and delivering SMS message.
Roaming	Enable or disable roaming.
IPv4 Subnet Mask	Customize the cellular subnet mask. If blank, the device will use the subnet mask provided by the cellular base station.
Data Limit	When you reach the specified data usage limit, the data connection of the currently used SIM card will be disabled. 0 means disable the function.
Billing Day	Choose the billing day of the SIM card, then the router will reset the data used to 0.

**SIM1-APN1**

Interface Name: **SIM1-APN1**

Protocol Type: IPv4

APN:

Username:

Password:

Authentication Type: None

PPP Preferred:

Enable NAT:

IPv4 Primary DNS:

IPv4 Secondary DNS:

IPv6 Primary DNS:

IPv6 Secondary DNS:

Customize MTU:

MTU: 1500

OK
Cancel

SIM-APN	
Item	Description
Interface Name	Display the name of the currently configured interface.
Auto APN	<p>Enable to automatically detect the carrier and use the built-in APN database for automatic connection. When using Auto APN, there is no need to fill in protocol type, APN, username, password, and authentication method.</p> <p><b>Note:</b></p> <ul style="list-style-type: none"> <li>● Only the APN1 of each SIM card can use Auto APN.</li> <li>● On the same SIM card, Auto APN and Multi-APN cannot be enabled simultaneously.</li> </ul>
Protocol Type	Select from "IPv4", "IPv6" and "IPv4/IPv6"
APN	Enter the Access Point Name for the cellular dial-up connection provided by the local ISP.
Username	Enter the username for the cellular dial-up connection provided by the

	local ISP.
Password	Enter the password for the cellular dial-up connection provided by the local ISP.
Authentication Type	Select from "None", "PAP", or "CHAP".
PPP Preferred	The PPP dial-up method is preferred.
Enable NAT	Enable or disable NAT function.
IPv4/IPv6 Primary DNS	IPv4/IPv6 address of the preferred DNS server.
IPv4/IPv6 Secondary DNS	IPv4/IPv6 address of the secondary DNS server.
Customize MTU	Enable or disable to customize the maximum transmission units. When disabled, the device will use the operator's MTU settings.
MTU	Customize the maximum transmission units.

## Related Topics

[Cellular Network Connection](#)

[Phone Group](#)

[DI Setting](#)

### 5.2.1.2 Port

This section describes how to configure the Ethernet port parameters.

The router supports 1 Fast Ethernet port.

Port Setting				
Port	Connection Status	Status	Speed	Duplex
LAN	Connected	up	auto	auto

Port Setting	
Item	Description
Port	Users can define the Ethernet ports according to their needs.
Status	Set the status of Ethernet port; select "up" to enable and "down" to disable.
Speed	Set the Ethernet port's speed. The options are "auto", "100 Mbps", and "10 Mbps".
Duplex	Set the Ethernet port's mode. The options are "auto", "full", and "half".

### 5.2.1.3 USB

UR41(L) equips with a USB 2.0 port for power supply or can work as a LAN port to provide network to terminal devices.

### 5.2.1.4 Bridge

Bridge setting is used for managing local area network devices which are connected to LAN ports of the router, allowing each of them to access the Internet.

Bridge		
Item	Description	Default
Name	Show the name of bridge. "Bridge0" is set by default and cannot be changed.	Bridge0
STP	Enable/disable STP.	Disable
IP Address	Set the IP address for bridge.	192.168.1.1
Netmask	Set the Netmask for bridge.	255.255.255.0
IPv6 Address	Set the IPv6 address for bridge.	2004::1/64
MTU	Set the maximum transmission unit. Range: 68-1500.	1500
Multiple IP Address	Set the multiple IP addresses for bridge.	Null

### 5.2.1.5 Loopback

Loopback interface is used for replacing router's ID as long as it is activated. When the interface is DOWN, the ID of the router has to be selected again which leads to long convergence time of OSPF. Therefore, Loopback interface is generally recommended as the ID of the router.

Loopback interface is a logic and virtual interface on router. Under default conditions, there's no loopback interface on router, but it can be created as required.

Cellular Port USB Bridge Loopback

**Loopback Address**

IP Address

Netmask

**Multiple IP Addresses**

IP Address	Netmask	Operation
		+

Loopback		
Item	Description	Default
IP Address	Unalterable	127.0.0.1
Netmask	Unalterable	255.0.0.0
Multiple IP Addresses	Apart from the IP above, user can configure other IP addresses.	Null

## 5.2.2 DHCP

DHCP adopts Client/Server communication mode. The Client sends configuration request to the Server which feeds back corresponding configuration information and distributes IP address to the Client so as to achieve the dynamic configuration of IP address and other information.

### 5.2.2.1 DHCP Server/DHCPv6 Server

The router can be set as a DHCP server or DHCPv6 server to distribute IP address when a host logs on and ensures each host is supplied with different IP addresses. DHCP Server has simplified some previous network management tasks requiring manual operations to the largest extent. The router only supports stateful DHCPv6 when working as DHCPv6 server.

DHCP Server
DHCPv6 Server
DHCP Relay

---

— DHCP Server\_1

Enable

Interface Bridge0

Start Address 192.168.45.100

End Address 192.168.45.199

Netmask 255.255.255.0

Lease Time(Min) 1440

Primary DNS Server 192.168.1.1

Secondary DNS Server 8.8.8.8

Windows Name Server

**Static IP**

MAC Address	IP Address	Operation
+		

DHCP Server
DHCPv6 Server
DHCP Relay

---

— DHCPv6 Server\_1

Enable

Interface Bridge0

Start Address 2001:D0B0:3000:3001::100

End Address 2001:D0B0:3000:3001::199

Prefix Length 64

Lease Time(Min) 1440

Primary DNS Server 2001:D0B0:3000:3001::1

Secondary DNS Server 2001:4860:4860::8888

**Static IP**

DUID	IPv6 Address	Operation
+		

**DHCP Server**

Item	Description	Default
------	-------------	---------

Enable	Enable or disable DHCP server.	Enable
Interface	Select interface.	Bridge0
Start Address	Define the beginning of the pool of IP addresses which will be leased to DHCP clients.	192.168.1.100
End Address	Define the end of the pool of IP addresses which will be leased to DHCP clients.	192.168.1.199
Netmask	Define the subnet mask of IPv4 address obtained by DHCP clients from DHCP server.	255.255.255.0
Prefix Length	Set the IPv6 prefix length of IPv6 address obtained by DHCP clients from DHCP server.	64
Lease Time (Min)	Set the lease time on which the client can use the IP address obtained from DHCP server. Range: 1-10080.	1440
Primary DNS Server	Set the primary DNS server.	192.168.1.1
Secondary DNS Server	Set the secondary DNS server.	Null
Windows Name Server	Define the Windows Internet Naming Service obtained by DHCP clients from DHCP sever. Generally you can leave it blank.	Null
<b>Static IP</b>		
MAC Address	Set a static and specific MAC address for the DHCP client (it should be different from other MACs so as to avoid conflict).	Null
DUID	Set a static and specific DUID for the DHCPv6 client (it should be different from other DUID so as to avoid conflict).	Null
IP Address	Set a static and specific IP address for the DHCP client (it should be outside of the DHCP range).	Null

### 5.2.2.2 DHCP Relay

The router can be set as DHCP Relay to provide a relay tunnel to solve the problem that DHCP Client and DHCP Server are not in the same subnet.

DHCP Server
DHCPv6 Server
DHCP Relay

**DHCP Relay**

Enable

DHCP Server

DHCP Relay	
Item	Description

Enable	Enable or disable DHCP relay.
DHCP Server	Set DHCP server, up to 10 servers can be configured; separate them by blank space or ",".

### 5.2.3 Firewall

This section describes how to set the firewall parameters, including security, ACL, DMZ, Port Mapping, MAC Binding and SPI.

The firewall implements corresponding control of data flow at entry direction (from Internet to local area network) and exit direction (from local area network to Internet) according to the content features of packets, such as protocol style, source/destination IP address, etc. It ensures that the router operate in a safe environment and host in local area network.



## Keyword Blocking

You can block specific website by entering keyword. The maximum number of character allowed is 64.

### 5.2.3.2 ACL

Access control list, also called ACL, implements permission or prohibition of access for specified network traffic (such as the source IP address) by configuring a series of matching rules so as to filter the network interface traffic. When router receives packet, the field will be analyzed according to the ACL rule applied to the current interface. After the special packet is identified, the permission or prohibition of corresponding packet will be implemented according to preset strategy.

The data package matching rules defined by ACL can also be used by other functions requiring flow distinction.

The screenshot displays the ACL configuration page. At the top, there are navigation tabs: Security, ACL (active), Port Mapping, DMZ, MAC Binding, Custom Rules, and SPI. The main content area is divided into sections:

- ACL Setting:** A dropdown menu for 'Default Filter Policy' is currently set to 'Accept'.
- Access Control List:** A table with columns: ID, Action, Protocol, Source IP, Destination IP, More Detail, Description, and Operation. A '+' button is in the bottom right corner.
- Interface List:** A table with columns: Interface, In ACL, Out ACL, and Operation. A '+' button is in the bottom right corner.

A 'Save' button is located at the bottom left of the configuration area.

Item	Description
<b>ACL Setting</b>	
Default Filter Policy	Select from "Accept" and "Deny". The packets which are not included in the access control list will be processed by the default filter policy.
<b>Access Control List</b>	
Type	Select type from "Extended" and "Standard".
ID	User-defined ACL number. Range: 1-199.
Action	Select from "Permit" and "Deny".
Protocol	Select protocol from "ip", "icmp", "tcp", "udp", and "1-255".
Source IP	Source network address (leaving it blank means all).
Source Wildcard Mask	Wildcard mask of the source network address.
Destination IP	Destination network address (0.0.0.0 means all).
Destination Wildcard Mask	Wildcard mask of destination address.
Description	Fill in a description for the groups with the same ID.
ICMP Type	Enter the type of ICMP packet. Range: 0-255.
ICMP Code	Enter the code of ICMP packet. Range: 0-255.

Source Port Type	Select source port type, such as specified port, port range, etc.
Source Port	Set source port number. Range: 1-65535.
Start Source Port	Set start source port number. Range: 1-65535.
End Source Port	Set end source port number. Range: 1-65535.
Destination Port Type	Select destination port type, such as specified port, port range, etc.
Destination Port	Set destination port number. Range: 1-65535.
Start Destination Port	Set start destination port number. Range: 1-65535.
End Destination Port	Set end destination port number. Range: 1-65535.
More Details	Show information of the port.
<b>Interface List</b>	
Interface	Select network interface for access control.
In ACL	Select a rule for incoming traffic from ACL ID.
Out ACL	Select a rule for outgoing traffic from ACL ID.

## Related Configuration Example

[Access Control Application Example](#)

### 5.2.3.3 Port Mapping

Port mapping is an application of network address translation (NAT) that redirects a communication request from the combination of an address and port number to another while the packets are traversing a network gateway such as a router or firewall.

Port Mapping

Source IP	Source Port	Destination IP	Destination Port	Protocol	Description	Operation
<input type="text" value="0.0.0.0/0"/>	<input type="text"/>	<input type="text"/>	<input type="text"/>	TCP	<input type="text"/>	✕
						+

Port Mapping	
Item	Description
Source IP	Specify the host or network which can access local IP address. 0.0.0.0/0 means all.
Source Port	Enter the TCP or UDP port from which incoming packets are forwarded. Range: 1-65535.
Destination IP	Enter the IP address that packets are forwarded to after being received on the incoming interface.
Destination Port	Enter the TCP or UDP port that packets are forwarded to after being received on the incoming port(s). Range: 1-65535.
Protocol	Select from "TCP" and "UDP" as your application required.
Description	The description of this rule.

## Related Configuration Example

[NAT Application Example](#)

### 5.2.3.4 DMZ

DMZ is a host within the internal network that has all ports exposed, except those forwarded ports in port mapping.

The screenshot shows a configuration panel for DMZ. At the top, there is a tab labeled 'DMZ'. Below it, there is an 'Enable' checkbox which is currently unchecked. Underneath, there are two input fields: 'DMZ Host' and 'Source Address'. At the bottom of the panel is a blue 'Save' button.

DMZ	
Item	Description
Enable	Enable or disable DMZ.
DMZ Host	Enter the IP address of the DMZ host on the internal network.
Source Address	Set the source IP address which can access to DMZ host. "0.0.0.0/0" means any address.

### 5.2.3.5 MAC Binding

MAC Binding is used for specifying hosts by matching MAC addresses and IP addresses that are in the list of allowed outer network access.

The screenshot shows a configuration panel for MAC Binding List. At the top, there is a tab labeled 'MAC Binding List'. Below it, there is a table with four columns: 'MAC', 'IP', 'Description', and 'Operation'. The 'Operation' column contains a plus sign icon. At the bottom of the panel is a blue 'Save' button.

MAC Binding List	
Item	Description
MAC Address	Set the binding MAC address.
IP Address	Set the binding IP address.
Description	Fill in a description for convenience of recording the meaning of the binding rule for each piece of MAC-IP.

### 5.2.3.6 Custom Rules

In this page, you can configure your own custom firewall iptables rules.

| Custom Rules

Rule	Description	Operation
Eg: -t filter -I INPUT -s 192.168.3.240 -j DROP		<input type="checkbox"/>
		<input type="checkbox"/>

Custom Rules	
Item	Description
Rule	Specify an iptables rule like the example shows. Tips: You must reboot the device to take effect after modifying or deleting the iptables rules.
Description	Enter the description of the rule.

### 5.2.3.7 SPI

| SPI Firewall

- Enable
- Filter Proxy
- Filter Cookies
- Filter Activex
- Filter Java Applets
- Filter Multicast
- Filter IDENT(port 113)
- Block Wan SNMP access
- Filter WAN NAT Redirection
- Block Anonymous Wan Request

SPI Firewall	
Item	Description
Enable	Enable/disable SPI firewall.
Filter Proxy	Blocks HTTP requests containing the "Host": string.
Filter Cookies	Identifies HTTP requests that contain "Cookie": String and

	mangle the cookie. Attempts to stop cookies from being used.
Filter ActiveX	Blocks HTTP requests of the URL that ends in ".ocx" or ".cab".
Filter Java Applets	Blocks HTTP requests of the URL that ends in ".js" or ".class".
Filter Multicast	Prevent multicast packets from reaching the LAN.
Filter IDENT(port 113)	Prevent WAN access to Port 113.
Block WAN SNMP access	Block SNMP requests from the WAN.
Filter WAN NAT Redirection	Prevent hosts on LAN from using WAN address of router to connect servers on the LAN (which have been configured using port redirection).
Block Anonymous WAN Requests	Stop the router from responding to "pings" from the WAN.

### 5.2.4 QoS

Quality of service (QoS) refers to traffic prioritization and resource reservation control mechanisms rather than the achieved service quality. QoS is engineered to provide different priority for different applications, users, data flows, or to guarantee a certain level of performance to a data flow.

QoS(Download)
QoS(Upload)

---

**Download Bandwidth**

Enable

Default Category

Download Bandwidth  kbits/s

Capacity

**Service Category**

Name	Percent(%)	Max BW(kbps)	Min BW(kbps)	Operation
				+

**Service Category Rules**

Name	Source IP	Source Port	Destination IP	Destination Port	Protocol	Service Category	Operation
							+

[Save](#)

QoS	
Item	Description
<b>Download/Upload</b>	
Enable	Enable or disable QoS.
Default Category	Select the default category from Service Category list.
Download/Upload	The download/upload bandwidth capacity of the network

Bandwidth Capacity	that the router is connected with, in kbps. Range: 1-8000000.
<b>Service Category</b>	
Name	You can use characters such digits, letters and "-".
Percent (%)	Set percent for the service category. Range: 0-100.
Max BW(kbps)	The maximum bandwidth that this category is allowed to consume, in kbps. The value should be less than the "Download/Upload Bandwidth Capacity" when the traffic is blocked.
Min BW(kbps)	The minimum bandwidth that can be guaranteed for the category, in kbps. The value should be less than the "MAX BW" value.
<b>Service Category Rules</b>	
<b>Item</b>	<b>Description</b>
Name	Give the rule a descriptive name.
Source IP	Source address of flow control (leaving it blank means any).
Source Port	Source port of flow control. Range: 0-65535 (leaving it blank means any).
Destination IP	Destination address of flow control (leaving it blank means any).
Destination Port	Destination port of flow control. Range: 0-65535 (leaving it blank means any).
Protocol	Select protocol from "ANY", "TCP", "UDP", "ICMP", and "GRE".
Service Category	Set service category for the rule.

## Related Configuration Example

[QoS Application Example](#)

### 5.2.5 VPN

Virtual Private Networks, also called VPNs, are used to securely connect two private networks together so that devices can connect from one network to the other network via secure channels. The router supports DMVPN, IPsec, GRE, L2TP, PPTP, OpenVPN, as well as GRE over IPsec and L2TP over IPsec.

#### 5.2.5.1 DMVPN

A dynamic multi-point virtual private network (DMVPN), combining mGRE and IPsec, is a secure network that exchanges data between sites without passing traffic through an organization's headquarter VPN server or router.

**DMVPN Settings**

Enable	<input checked="" type="checkbox"/>
Hub Address	<input type="text"/>
Local IP Address Type	Interface Get <span>▼</span>
Interface	SIM1-APN1 <span>▼</span>
GRE HUB IP Address	<input type="text"/>
GRE Local IP Address	<input type="text"/>
GRE Mask	255.255.255.0
GRE Key	<input type="text"/>
Negotiation Mode	Main <span>▼</span>
Authentication Algorithm	AES128 <span>▼</span>
Encryption Algorithm	MD5 <span>▼</span>
DH Group	MODP768-1 <span>▼</span>
Key	<input type="text"/>
Local ID Type	Default <span>▼</span>
IKE Life Time(s)	10800
SAAlgorithm	AES128-MD5 <span>▼</span>
PFS Group	NULL <span>▼</span>
Life Time(s)	3600
DPD Time Interval(s)	30
DPD Timeout(s)	150
Cisco Secret	<input type="text"/>
NHRP Holdtime(s)	7200

DMVPN	
Item	Description
Enable	Enable or disable DMVPN.
Hub Address	The IP address or domain name of DMVPN Hub.
Local IP Address Type	Local IP address obtaining method. Select from "Manual Input" and "Interface Get".
Local IP address	DMVPN local tunnel IP address.
Interface	Select the interface IP address to be used.
GRE Hub IP Address	GRE Hub tunnel IP address.
GRE Local IP Address	GRE local tunnel IP address.
GRE Netmask	GRE local tunnel netmask.
GRE Key	GRE tunnel key.
Negotiation Mode	Select from "Main" and "Aggressive".
Authentication	Select from "DES", "3DES", "AES128", "AES192" and

Algorithm	"AES256".
Encryption Algorithm	Select from "MD5", "SHA1" and "SHA2-256".
DH Group	Select from "MODP768_1", "MODP1024_2", "MODP1536_5", "MODP2048-14" and "MODP3072-15".
Key	Enter the preshared key.
Local ID Type	Select from "Default", "ID", "FQDN", and "User FQDN"
IKE Life Time (s)	Set the lifetime in IKE negotiation. Range: 60-86400.
SA Algorithm	Select from "DES_MD5", "DES_SHA1", "AES128-SHA256", "3DES_MD5", "3DES_SHA1", "AES128_MD5", "AES128_SHA1", "AES192_MD5", "AES192_SHA1", "AES192-SHA256", "AES256_MD5", "AES256-SHA256" and "AES256_SHA1".
PFS Group	Select from "NULL", "MODP768_1", "MODP1024_2" and "MODP1536-5".
Life Time (s)	Set the lifetime of IPsec SA. Range: 60-86400.
DPD Interval Time (s)	Set DPD interval time
DPD Timeout (s)	Set DPD timeout.
Cisco Secret	Cisco Nhrp key.
NHRP Holdtime (s)	The holdtime of NHRP protocol.

### 5.2.5.2 IPsec Server

IPsec is especially useful for implementing virtual private networks and for remote user access through dial-up connection to private networks. A big advantage of IPsec is that security arrangements can be handled without requiring changes to individual user computers.

IPsec provides three choices of security service: Authentication Header (AH), Encapsulating Security Payload (ESP), and Internet Key Exchange (IKE). AH essentially allows authentication of the senders' data. ESP supports both authentication of the sender and data encryption. IKE is used for cipher code exchange. All of them can protect one and more data flows between hosts, between host and gateway, and between gateways.

**IPsec Server**

Enable

IPsec Mode

IPsec Protocol

Local Subnet  +

Local ID Type

Remote Subnet  +

Remote ID Type

IPsec Server	
Item	Description
Enable	Enable or disable IPsec server mode.
IPsec Mode	Select Tunnel or Transport.
IPsec Protocol	Select from ESP or AH.
Local Subnet	Enter the local LAN subnet IP address on the IPsec tunnel. <b>Note:</b> Only when IKE version = IKEv2, is it supported to add multiple local subnets.
Local ID Type	Select the identifier type, and send it to remote peer. <b>Default:</b> None <b>ID:</b> use local subnet IP address as ID <b>FQDN:</b> fully qualified domain name, example: test.user.com <b>User FQDN:</b> fully qualified username string with email address format, example: test@user.com
Remote Subnet	Set the remote LAN subnet on the IPsec tunnel. <b>Note:</b> Only when IKE version = IKEv2, is it supported to add multiple remote subnets.
Remote ID type	Select the identifier type that is the same as remote peer local ID. <b>Default:</b> None <b>ID:</b> use remote subnet IP address as ID <b>FQDN:</b> fully qualified domain name, example: test.user.com <b>User FQDN:</b> fully qualified username string with email address format, example: test@user.com

IKE Parameter ▼ Collapse

IKE Version

Negotiation Mode

Encryption Algorithm

Authentication Algorithm

DH Group

Local Authentication

XAUTH

Lifetime(s)

XAUTH List

Username	Password	Operation
		<a href="#">+</a>

<b>SA Parameter</b>		<a href="#">Collapse</a>
SA Encryption Algorithm	<input type="text" value="DES"/>	
SA Authentication Algorithm	<input type="text" value="MD5"/>	
PFS Group	<input type="text" value="NULL"/>	
Lifetime(s)	<input type="text" value="3600"/>	
DPD Time Interval(s)	<input type="text" value="30"/>	
DPD Timeout(s)	<input type="text" value="150"/>	
<b>IPsec Advanced</b>		<a href="#">Collapse</a>
Enable Compression	<input type="checkbox"/>	
MarginTime(s)	<input type="text" value="100"/>	
VPN Over IPsec Type	<input type="text" value="NONE"/>	
Expert Options	<input type="text"/>	

IKE Parameter	
Item	Description
IKE Version	Select the method of key exchange from IKEv1 and IKEv2.
Negotiation Mode	When using IKEv1, select Main or Aggressive.
Encryption Algorithm	Select DES, 3DES, AES128, AES192 or AES256.
Authentication Algorithm	Select MD5, SHA1 or SHA2-256.
DH Group	Select MODP768-1, MODP1024-2, MODP1536-5, MODP2048-14 or MODP3072-15.
Local Authentication	Select PSK or CA. <b>PSK:</b> use pre-shared key to complete the authentication. <b>CA:</b> use certificate to complete the authentication. After selecting, go to <b>Network &gt; VPN &gt; Certifications</b> page to import CA certificate, local certificate and private key to corresponding fields.
Remote Authentication	When using IKEv2, select PSK or CA. <b>PSK:</b> use pre-shared key to complete the authentication. <b>CA:</b> use certificate to complete the authentication. After selecting, go to <b>Network &gt; VPN &gt; Certifications</b> page to import remote certificate to corresponding fields.
XAUTH	When using IKEv1, define XAUTH username and password after XAUTH is enabled.
Lifetime (s)	Set the lifetime in IKE negotiation. Range: 60-86400.
XAUTH List	
Username	Enter the username used for the xauth authentication.
Password	Enter the password used for the xauth authentication.
PSK List	
Selector	Enter the corresponding identification number for PSK authentication.
PSK	Enter the pre-shared key.
SA Parameter	
SA Encryption Algorithm	Select DES, 3DES, AES128, AES192 or AES256.

SA Authentication Algorithm	Select MD5, SHA1 or SHA2-256.
PFS Group	Select NULL, MODP768-1 , MODP1024-2 or MODP1536-5.
Lifetime (s)	Set the lifetime of IPsec SA. Range: 60-86400 s.
DPD Time Interval(s)	Set DPD retry interval to send DPD requests. Range: 1-86400 s
DPD Timeout(s)	Set DPD timeout to detect the remote side fails. Range: 10-86400 s.
<b>IPsec Advanced</b>	
Enable Compression	The head of IP packet will be compressed after it's enabled.
Margintime	Set advanced time before the lifetime expires to begin the re-negotiation.
VPN Over IPsec Type	Select from NONE, GRE and L2TP.
Expert Options	User can enter some other initialization strings in this field and separate the strings with semicolon.

### 5.2.5.3 IPsec

The router supports running at most 3 IPsec clients at the same time.

The screenshot shows the configuration page for IPsec\_1. The 'Enable' checkbox is unchecked. The 'IPsec Gateway Address' is an empty text field. 'IPsec Mode' is set to 'Tunnel' and 'IPsec Protocol' is set to 'ESP'. 'Local Subnet' is an empty text field. 'Local ID Type' is set to 'Default'. 'Remote Subnet' is an empty text field. 'Remote ID Type' is set to 'Default'. There are three expandable sections: 'IKE Parameter', 'SA Parameter', and 'IPsec Advanced', each with a blue '>> Expand' link. 'Expert Options' is an empty text field. Below the main configuration area, there are two collapsed sections for 'IPsec\_2' and 'IPsec\_3', each with a blue '+' icon.

IPsec	
Item	Description
Enable	Enable or disable IPsec client mode. A maximum of 3 tunnels is allowed.
IP Gateway Address	Enter the remote IPsec server address.
IPsec Mode	Select Tunnel or Transport.
IPsec Protocol	Select from ESP or AH.
Local Subnet	Enter the local LAN subnet IP address on the IPsec tunnel. <b>Note:</b> Only when IKE version = IKEv2, it can supported to add up to 10 multiple local subnets.
Local ID Type	Select the identifier type, and send it to remote peer. <b>Default:</b> None

	<p><b>ID:</b> use local subnet IP address as ID</p> <p><b>FQDN:</b> fully qualified domain name, example: test.user.com</p> <p><b>User FQDN:</b> fully qualified username string with email address format, example: test@user.com</p>
Remote Subnet	<p>Set the remote LAN subnet on the IPsec tunnel.</p> <p><b>Note:</b> Only when IKE version = IKEv2, it can supported to add up to 10 multiple remote subnets.</p>
Remote ID type	<p>Select the identifier type that is the same as remote peer local ID.</p> <p><b>Default:</b> None</p> <p><b>ID:</b> use remote subnet IP address as ID</p> <p><b>FQDN:</b> fully qualified domain name, example: test.user.com</p> <p><b>User FQDN:</b> fully qualified username string with email address format, example: test@user.com</p>

<b>IKE Parameter</b>	<a href="#">Collapse</a>
IKE Version	IKEv1
Negotiation Mode	Main
Encryption Algorithm	DES
Authentication Algorithm	MD5
DH Group	MODP768-1
Local Authentication	PSK
Local Secrets	<input type="text"/>
XAUTH	<input type="checkbox"/>
Lifetime(s)	10800
<b>SA Parameter</b>	<a href="#">Collapse</a>
SA Encryption Algorithm	DES
SA Authentication Algorithm	MD5
PFS Group	NULL
Lifetime(s)	3600
DPD Time Interval(s)	30
DPD Timeout(s)	150
<b>IPsec Advanced</b>	<a href="#">Collapse</a>
Enable Compression	<input type="checkbox"/>
Margintime(s)	100
VPN Over IPsec Type	NONE
Expert Options	<input type="text"/>

IKE Parameter	
Item	Description
IKE Version	Select the method of key exchange from IKEv1 and IKEv2.
Negotiation Mode	When using IKEv1, select Main or Aggressive.
Encryption Algorithm	Select DES, 3DES, AES128, AES192 or AES256.
Authentication Algorithm	Select MD5, SHA1 or SHA2-256.
DH Group	Select MODP768-1, MODP1024-2, MODP1536-5, MODP2048-14 or MODP3072-15.
Local Authentication	Select PSK or CA. <b>PSK:</b> use pre-shared key to complete the authentication. <b>CA:</b> use certificate to complete the authentication. After selecting, go to <b>Network &gt; VPN &gt; Certifications</b> page to import CA certificate, local certificate and private key to corresponding fields.

Local Secrets	Enter the pre-shared key which is defined on server side.
Remote Authentication	When using IKEv2, select PSK or CA. <b>PSK:</b> use pre-shared key to complete the authentication. <b>CA:</b> use certificate to complete the authentication. After selecting, go to <b>Network &gt; VPN &gt; Certifications</b> page to import remote certificate to corresponding fields.
Remote Secrets	Enter the pre-shared key which is defined on server side.
XAUTH	Enter XAUTH username and password which is defined on server side.
Lifetime (s)	Set the lifetime in IKE negotiation. Range: 60-86400.
<b>SA Parameter</b>	
SA Encryption Algorithm	Select DES, 3DES, AES128, AES192 or AES256.
SA Authentication Algorithm	Select MD5, SHA1 or SHA2-256.
PFS Group	Select NULL, MODP768-1 , MODP1024-2 or MODP1536-5.
Lifetime (s)	Set the lifetime of IPsec SA. Range: 60-86400 s.
DPD Time Interval(s)	Set DPD retry interval to send DPD requests. Range: 1-86400 s
DPD Timeout(s)	Set DPD timeout to detect the remote side fails. Range: 10-86400 s.
<b>IPsec Advanced</b>	
Enable Compression	The head of IP packet will be compressed after it's enabled.
Margintime	Set advanced time before the lifetime expires to begin the re-negotiation.
VPN Over IPsec Type	Select from NONE, GRE and L2TP.
Expert Options	User can enter some other initialization strings in this field and separate the strings with semicolon.

#### 5.2.5.4 GRE

Generic Routing Encapsulation (GRE) is a protocol that encapsulates packets in order to route other protocols over IP networks. It's a tunneling technology that provides a channel through which encapsulated data message could be transmitted and encapsulation and decapsulation could be realized at both ends.

In the following circumstances the GRE tunnel transmission can be applied:

- GRE tunnel could transmit multicast data packets as if it were a true network interface. Single use of IPsec cannot achieve the encryption of multicast.
- A certain protocol adopted cannot be routed.
- A network of different IP addresses shall be required to connect other two similar networks.

**GRE Settings**

**GRE\_1**

Enable

Remote IP Address

Local IP Address

Local Virtual IP Address

Netmask

Peer Virtual IP Address

Global Traffic Forwarding

Remote Subnet

Remote Netmask

MTU

Key

Enable NAT

**GRE\_2**

**GRE\_3**

GRE	
Item	Description
Enable	Check to enable GRE function.
Remote IP Address	Enter the real remote IP address of GRE tunnel.
Local IP Address	Set the local IP address.
Local Virtual IP Address	Set the local tunnel IP address of GRE tunnel.
Netmask	Set the local netmask.
Peer Virtual IP Address	Enter remote tunnel IP address of GRE tunnel.
Global Traffic Forwarding	All the data traffic will be sent out via GRE tunnel when this function is enabled.
Remote Subnet	Enter the remote subnet IP address of GRE tunnel.
Remote Netmask	Enter the remote netmask of GRE tunnel.
MTU	Enter the maximum transmission unit. Range: 64-1500.
Key	Set GRE tunnel key.
Enable NAT	Enable NAT traversal function.

### 5.2.5.5 L2TP

Layer Two Tunneling Protocol (L2TP) is an extension of the Point-to-Point Tunneling Protocol (PPTP) used by an Internet service provider (ISP) to enable the operation of a virtual private network (VPN) over the Internet.

L2TP Settings

— L2TP\_1

Enable

Remote IP Address

Hostname

Username

Password  

Authentication

Global Traffic Forwarding

Remote Subnet

Remote Subnet Mask

Key  

Advanced Settings [» Expand](#)

+ L2TP\_2

+ L2TP\_3

L2TP	
Item	Description
Enable	Check to enable L2TP function.
Remote IP Address	Enter the public IP address or domain name of L2TP server.
Hostname	Enter the hostname to verify with L2TP server.
Username	Enter the username that L2TP server provides.
Password	Enter the password that L2TP server provides.
Authentication	Select from "Auto", "PAP", "CHAP", "MS-CHAPv1" and "MS-CHAPv2".
Global Traffic Forwarding	All of the data traffic will be sent out via L2TP tunnel after this function is enabled.
Remote Subnet	Enter the remote IP address that L2TP protects.
Remote Subnet Mask	Enter the remote netmask that L2TP protects.
Key	Enter the password of L2TP tunnel.

## Advanced Settings

 Collapse

Local IP Address

Peer IP Address

Enable NAT

Enable MPPE

Address/Control Compression

Protocol Field Compression

Asynomap Value

MRU

MTU

Link Detection Interval(s)

Max Retries

Expert Options

Advanced Settings	
Item	Description
Local IP Address	Set tunnel IP address of L2TP client. Client will obtain tunnel IP address automatically from the server when it's null.
Peer IP Address	Enter tunnel IP address of L2TP server.
Enable NAT	Enable NAT traversal function.
Enable MPPE	Enable MPPE encryption.
Address/Control Compression	For PPP initialization. User can keep the default option.
Protocol Field Compression	For PPP initialization. User can keep the default option.
Asyncmap Value	One of the PPP protocol initialization strings. User can keep the default value. Range: 0-ffffff.
MRU	Set the maximum receive unit. Range: 64-1500.
MTU	Set the maximum transmission unit. Range: 64-1500
Link Detection Interval (s)	Set the link detection interval time to ensure tunnel connection. Range: 0-600.
Max Retries	Set the maximum times of retry to detect the L2TP connection failure. Range: 0-10.
Expert Options	User can enter some other PPP initialization strings in this field and separate the strings with blank space.

### 5.2.5.6 PPTP

Point-to-Point Tunneling Protocol (PPTP) is a protocol that allows corporations to extend their own corporate network through private "tunnels" over the public Internet. Effectively, a corporation uses a wide-area network as a single large local area network.

**PPTP Settings**

— PPTP\_1

Enable	<input type="checkbox"/>
Remote IP Address	<input type="text"/>
Username	<input type="text"/>
Password	<input type="password"/>
Authentication	<input type="text" value="Auto"/> ▼
Global Traffic Forwarding	<input type="checkbox"/>
Remote Subnet	<input type="text"/>
Remote Subnet Mask	<input type="text"/>
Advanced Settings	<a href="#">» Expand</a>

+ PPTP\_2

+ PPTP\_3

PPTP	
Item	Description
Enable	Enable PPTP client. A maximum of 3 tunnels is allowed.
Remote IP Address	Enter the public IP address or domain name of PPTP server.
Username	Enter the username that PPTP server provides.
Password	Enter the password that PPTP server provides.
Authentication	Select from "Auto", "PAP", "CHAP", "MS-CHAPv1", and "MS-CHAPv2".
Global Traffic Forwarding	All of the data traffic will be sent out via PPTP tunnel once enable this function.
Remote Subnet	Set the peer subnet of PPTP.
Remote Subnet Mask	Set the netmask of peer PPTP server.

Advanced Settings ⌵ Collapse

Local IP Address

Peer IP Address

Enable NAT

Enable MPPE

Address/Control Compression

Protocol Field Compression

Asynmap Value

MRU

MTU

Link Detection Interval(s)

Max Retries

Expert Options

PPTP Advanced Settings	
Item	Description
Local IP Address	Set IP address of PPTP client.
Peer IP Address	Enter tunnel IP address of PPTP server.
Enable NAT	Enable the NAT faction of PPTP.
Enable MPPE	Enable MPPE encryption.
Address/Control Compression	For PPP initialization. User can keep the default option.
Protocol Field Compression	For PPP initialization. User can keep the default option.
Asynmap Value	One of the PPP protocol initialization strings. User can keep the default value. Range: 0-ffffff.
MRU	Enter the maximum receive unit. Range: 0-1500.
MTU	Enter the maximum transmission unit. Range: 0-1500.
Link Detection Interval	Set the link detection interval time to ensure tunnel

(s)	connection. Range: 0-600.
Max Retries	Set the maximum times of retrying to detect the PPTP connection failure. Range: 0-10.
Expert Options	User can enter some other PPP initialization strings in this field and separate the strings with blank space.

## Related Configuration Example

[PPTP Application Example](#)

### 5.2.5.7 OpenVPN Client

OpenVPN is an open source virtual private network (VPN) product that offers a simplified security framework, modular network design, and cross-platform portability. The default OpenVPN version of the router is 2.4.9.

The router supports running at most 3 OpenVPN clients at the same time. You can import the ovpn file directly or configure the parameters on this page to set clients.

#### OpenVPN Client - File Configuration

Item	Description
Browse	Click to browse the client configuration ovpn format file including the settings and certificate contents. Please refer to the client configuration file according to sample: <a href="#">client.conf</a>
Edit	Click to edit the imported file.
Export	Export the server configuration file.
Delete	Click to delete the configuration file.

Enable	<input checked="" type="checkbox"/>
Configuration Method	Page Configuration
Protocol	UDP
Remote IP Address	
Port	1194
Interface	tun
Authentication	None
Local Tunnel IP	
Remote Tunnel IP	
Enable NAT	<input checked="" type="checkbox"/>
Compression	LZO
Link Detection Interval(s)	60
Link Detection Timeout(s)	300
Cipher	None
Authentication Mode	None
MTU	1500
Max Frame Size	1500
Verbose Level	ERROR
Expert Options	
Local Route	

Subnet	Subnet Mask	Operation
		<a href="#">+</a>

### OpenVPN Client - Page Configuration

Item	Description
Protocol	Select a transport protocol used by connecting UDP and TCP.
Remote IP Address	Enter remote OpenVPN server's IP address or domain name.
Port	Enter the TCP/UCP service number of remote OpenVPN server. Range: 1-65535.
Interface	Select virtual VPN network interface type from TUN and TAP. TUN devices encapsulate IPv4 or IPv6 (OSI Layer 3) while TAP devices encapsulate Ethernet 802.3 (OSI Layer 2).
Authentication Type	Select authentication type used to secure data sessions. <b>Pre-shared:</b> use the same secret key as server to complete the authentication. After selecting, go to <b>Network &gt; VPN &gt; Certifications</b> page to import a static.key to <b>PSK</b> field. <b>Username/Password:</b> use username/password which is preset in server side to complete the authentication. <b>X.509 cert:</b> use X.509 type certificate to complete the authentication. After selecting, go to <b>Network &gt; VPN &gt; Certifications</b> page to import CA certificate, client certificate and client private key to corresponding fields. <b>X.509 cert + user:</b> use both username/password and X.509 cert authentication type.
Local Virtual IP	Set local tunnel address when authentication type is <b>None</b> or <b>Pre-shared</b> .
Remote Virtual IP	Set remote tunnel address when authentication type is <b>None</b> or <b>Pre-shared</b> .
Global Traffic	All the data traffic will be sent out via OpenVPN tunnel when this function

Forwarding	is enabled.
Enable TLS Authentication	Select from None, TLS Auth and TLS Crypt. When selecting TLS Auth or TLS Crypt, go to <b>Network &gt; VPN &gt; Certifications</b> page to import a ta.key.
Compression	Select to enable or disable LZO to compress data.
Link Detection Interval (s)	Set link detection interval time to ensure tunnel connection. If this is set on both server and client, the value pushed from server will override the client local values. Range: 10-1800 s.
Link Detection Timeout (s)	OpenVPN will be reestablished after timeout. If this is set on both server and client, the value pushed from server will override the client local values. Range: 60-3600 s.
Cipher	Select from NONE, BF-CBC, DES-CBC, DES-EDE3-CBC, AES-128-CBC, AES-192-CBC and AES-256-CBC.
Authentication Mode	Select from NONE, MD5, SHA1, SHA256, and SHA512.
MTU	Enter the maximum transmission unit. Range: 128-1500.
Max Frame Size	Set the maximum frame size. Range: 128-1500.
Verbose Level	Select from ERROR, WARNING, NOTICE and DEBUG.
Expert Options	User can enter some initialization strings in this field and separate the strings with semicolon. <b>Example:</b> ncp-ciphers AES-128-GCM; key direction 1
<b>Local Route</b>	
Subnet	Set the local route's IP address.
Subnet Mask	Set the local route's netmask.

## Related Topic

[OpenVPN Client Application Example](#)

### 5.2.5.8 OpenVPN Server

The router supports OpenVPN server to create secure point-to-point or site-to-site connections in routed or bridged configurations and remote access facilities. Users can import the ovpn file directly or configure the parameters on this page to set this server. The router supports at most 20 openVPN clients connections.

**OpenVPN Server Settings**

Enable

Configuration Method

Configuration File

#### OpenVPN Server - File Configuration

Item	Description
Browse	Click to browse the server configuration ovpn format file including the settings and

	certificate contents. Please refer to the server configuration file according to sample: <a href="#">server.conf</a>
Edit	Click to edit the imported file.
Export	Export the server configuration file.
Delete	Click to delete the configuration file.

Enable	<input checked="" type="checkbox"/>
Configuration Method	Page Configuration ▾
Protocol	UDP ▾
Port	1194
Listening IP	<input type="text"/>
Interface	tun ▾
Authentication	None ▾
Local Virtual IP	<input type="text"/>
Remote Virtual IP	<input type="text"/>
Enable NAT	<input checked="" type="checkbox"/>
Compression	LZO ▾
Link Detection Interval	60
Link Detection Timeout	150
Cipher	None ▾
Authentication Mode	None ▾
MTU	1500
Max Frame Size	1500
Verbose Level	ERROR ▾
Expert Options	<input type="text"/>

<b>Account</b>			
	Username	Password	Operation
			+
<b>Local Route</b>			
	Subnet	Netmask	Operation
			+
<b>Client Subnet</b>			
	Name	Subnet	Netmask
			+

**OpenVPN Server - Page Configuration**

Item	Description
Protocol	Select a transport protocol used by connection from UDP and TCP.
Listening IP	Enter the local hostname or IP address for bind. If left blank, OpenVPN server will bind to all interfaces.
Port	Enter the TCP/UCP service number for OpenVPN client connection. Range: 1-65535.

Interface	Select virtual VPN network interface type from TUN and TAP. TUN devices encapsulate IPv4 or IPv6 (OSI Layer 3) while TAP devices encapsulate Ethernet 802.3 (OSI Layer 2).
Authentication Type	Select authentication type used to secure data sessions. <b>Pre-shared:</b> use the same secret key as server to complete the authentication. After select, go to <b>Network &gt; VPN &gt; Certifications</b> page to import a static.key to <b>PSK</b> field. <b>Username/Password:</b> use username/password which is preset in server side to complete the authentication. <b>X.509 cert:</b> use X.509 type certificate to complete the authentication. After select, go to <b>Network &gt; VPN &gt; Certifications</b> page to import CA certificate, client certificate and client private key to corresponding fields. <b>X.509 cert + user:</b> use both username/password and X.509 cert authentication type.
Local Virtual IP	Set local tunnel address when authentication type is <b>None</b> or <b>Pre-shared</b> .
Remote Virtual IP	Set remote tunnel address when authentication type is <b>None</b> or <b>Pre-shared</b> .
Client Subnet	Define an IP address pool for openVPN client.
Client Netmask	Set the client subnet netmask to limit the IP address range.
Renegotiation Interval	Renegotiate data channel key after this interval. 0 means disable.
Max Clients	Limit server to a maximum of concurrent clients, range: 1-20. <b>Note:</b> please adjust log severity to Info if you need to connect many clients.
Enable CRL	Enable or disable CRL verify.
Enable Client to Client	When enabled, openVPN clients can communicate with each other.
Enable Dup Client	Allow multiple clients to connect with the same common name or certification.
Enable TLS Authentication	Select from None, TLS Auth and TLS Crypt. When selecting TLS Auth or TLS Crypt, go to <b>Network &gt; VPN &gt; Certifications</b> page to import a ta.key.
Compression	Select to enable or disable LZO to compress data.
Link Detection Interval (s)	Set link detection interval time to ensure tunnel connection. If this is set on both server and client, the value pushed from server will override the client local values. Range: 10-1800 s.
Link Detection Timeout (s)	OpenVPN will be reestablished after timeout. If this is set on both server and client, the value pushed from server will override the client local values. Range: 60-3600 s.
Cipher	Select from NONE, BF-CBC, DES-CBC, DES-EDE3-CBC, AES-128-CBC, AES-192-CBC and AES-256-CBC.
Authentication Mode	Select from NONE, MD5, SHA1, SHA256, and SHA512.
MTU	Enter the maximum transmission unit. Range: 64-1500.
Max Frame Size	Set the maximum frame size. Range: 64-1500.
Verbose Level	Select from ERROR, WARING, NOTICE and DEBUG.
Expert Options	User can enter some initialization strings in this field and separate the strings with semicolon.

	<b>Example:</b> ncp-ciphers AES-128-GCM; key direction 1
<b>Account</b>	
Username & Password	Set username and password for OpenVPN client when authentication type is username/password.
<b>Local Route</b>	
Subnet	Set the local route's IP address.
Subnet Mask	Set the local route's netmask.
<b>Client Subnet</b>	
Name	Set the name as OpenVPN client certificate common name.
Subnet	Set the subnet of OpenVPN client.
Subnet Mask	Set the subnet netmask of OpenVPN client.

### 5.2.5.9 Certifications

User can import/export certificate and key files for OpenVPN and IPsec on this page.

OpenVPN Client

OpenVPN Client\_1

CA	<input type="text"/>	Browse	Import	Export	Delete
Public Certificate	<input type="text"/>	Browse	Import	Export	Delete
Private Key	<input type="text"/>	Browse	Import	Export	Delete
TA	<input type="text"/>	Browse	Import	Export	Delete
TLS Crypt	<input type="text"/>	Browse	Import	Export	Delete
Preshared Key	<input type="text"/>	Browse	Import	Export	Delete
PKCS12	<input type="text"/>	Browse	Import	Export	Delete

OpenVPN Server

CA	<input type="text"/>	Browse	Import	Export	Delete
Public Certificate	<input type="text"/>	Browse	Import	Export	Delete
Private Key	<input type="text"/>	Browse	Import	Export	Delete
DH	<input type="text"/>	Browse	Import	Export	Delete
TA	<input type="text"/>	Browse	Import	Export	Delete
TLS Crypt	<input type="text"/>	Browse	Import	Export	Delete
CRL	<input type="text"/>	Browse	Import	Export	Delete
Preshared Key	<input type="text"/>	Browse	Import	Export	Delete

**IPsec**

- IPsec\_1

CA	<input type="text"/>	<a href="#">Browse</a>	<a href="#">Import</a>	<a href="#">Export</a>	<a href="#">Delete</a>
Local Certificate	<input type="text"/>	<a href="#">Browse</a>	<a href="#">Import</a>	<a href="#">Export</a>	<a href="#">Delete</a>
Remote Certificate	<input type="text"/>	<a href="#">Browse</a>	<a href="#">Import</a>	<a href="#">Export</a>	<a href="#">Delete</a>
Private Key	<input type="text"/>	<a href="#">Browse</a>	<a href="#">Import</a>	<a href="#">Export</a>	<a href="#">Delete</a>
CRL	<input type="text"/>	<a href="#">Browse</a>	<a href="#">Import</a>	<a href="#">Export</a>	<a href="#">Delete</a>

+ IPsec\_2

+ IPsec\_3

**IPsec Server**

- IPsec Server

CA	<input type="text"/>	<a href="#">Browse</a>	<a href="#">Import</a>	<a href="#">Export</a>	<a href="#">Delete</a>
Local Certificate	<input type="text"/>	<a href="#">Browse</a>	<a href="#">Import</a>	<a href="#">Export</a>	<a href="#">Delete</a>
Private Key	<input type="text"/>	<a href="#">Browse</a>	<a href="#">Import</a>	<a href="#">Export</a>	<a href="#">Delete</a>
CRL	<input type="text"/>	<a href="#">Browse</a>	<a href="#">Import</a>	<a href="#">Export</a>	<a href="#">Delete</a>

### 5.2.5.10 WireGuard

WireGuard is an extremely simple yet fast and modern VPN that utilizes state-of-the-art cryptography. WireGuard passes traffic over UDP protocol.

**WireGuard\_1**



Enable	<input checked="" type="checkbox"/>	
Interface	wg0	
Customized Private Key	<input checked="" type="checkbox"/>	
Private Key	<input type="text"/>	
Public Key	IJGvOGVbxYigQbwWm0BN5a4	
IP Address	<input type="text"/>	
Listening Port	<input type="text"/>	
DNS	<input type="text"/>	
MTU	<input type="text"/>	

Peer	Public Key	Allowed IP	Endpoint Address	Enable Status	Operation
<a href="#">+</a>					

WireGuard	
Item	Description
Enable	Enable WireGuard interface. A maximum of 3 WireGaurd interfaces

	is allowed.
Interface	Show the WireGuard interface name.
Customized Private Key	Enable or disable to customize the private key of this WireGuard interface. If disabled, the client will use the private key generated by this router.
Public Key	Show the public key generated by the private key.
IP Address	Set the local virtual IP address and netmask. Example: 10.8.0.2/24
Listening Port	Set the port to send or receive WireGuard packets. The port numbers of different WireGuard interfaces should be different.
DNS	Set the DNS server address of this WireGuard interface. If left blank, the router will use DNS server address of common network interfaces (WAN, cellular, etc.).
MTU	Set the maximum transmission unit of this WireGuard interface. If left blank, the router will use MTU of common network interfaces (WAN, cellular, etc.).
Peer Table	Click "+" to add WireGuard peers of this WireGuard interface. One WireGuard interface can add 20 peers at most.

## Edit

Peer	<input type="text"/>
Public Key	<input type="text"/>
Allowed IP	<input type="text"/>  
Route Allowed IP	<input checked="" type="checkbox"/>
Preshared Key	<input type="text"/> 
Endpoint Address	<input type="text"/>
Endpoint Port	<input type="text"/>
Keepalive Interval	<input type="text" value="25"/>

Save

## WireGuard-Peer

Item	Description
Peer	Set a WireGuard peer name. This name should be unique in this WireGuard client.
Public Key	Set the public key of WireGuard peer server/client.
Allowed IP	Set the real IP address and netmask of WireGuard peer's LAN network. Example: 192.168.1.0/24 One WireGuard peer supports to add 8 allowed IP addresses.
Route Allowed IP	Enable or disable to add static routings of allowed IP addresses.
Preshared Key	Set the presahred key and both this interface and peer interface should set the same key value.
Endpoint Address	Set IP address or domain name of WireGuard peer server/client.

Endpoint Port	Set the destination port of WireGuard peer server/client.
Keepalive Interval	After the connection is established, this WireGuard interface will send heartbeat packet regularly to keep alive. 0 means disabled.

### 5.2.5.11 ZeroTier

ZeroTier is a way to connect devices over your own private network anywhere in the world. You do this by creating a network and then joining two or more devices to that network.

**ZeroTier Client**

NodeID

**ZeroTier Connection**

Name	NetworkID	Status	Interface Name	Enable	Operation
<input type="button" value="+"/>					

ZeroTier	
Item	Description
<b>ZeroTier Client</b>	
NodeID	The router's own automatically generated ID.
Refresh	Click to regenerate a new Node ID.
<b>ZeroTier Connection</b>	
Name	Customize the name of the connection.
NetworkID	The ZeroTier virtual Ethernet network that the router will join.
Status	Display the status of the connection between the router and the ZeroTier virtual Ethernet network.
Interface Name	Display the name of the virtualized network interface to which the router is added.
Enable	Check to enable this function.

**Add ZeroTier Connection**

Name

Enable

NetworkID

Interface Name

Allow Managed Addresses

Allow Assignment of Global IPs

Allow Default Route Override

Add ZeroTier Connection	
Item	Description
Name	Customize the name of the connection.
Enable	Check to enable this function
NetworkID	The ZeroTier virtual Ethernet network that the device will join.
Interface Name	Displays the name of the virtualized network interface to which the router is added.
Allow Managed Addresses	Allow or disable the ZeroTier controller to dynamically assign IP addresses and configure routing information when the router joins the network.
Allow Assignment of Global IPs	Allow or disallow ZeroTier network controllers to assign worldwide IPv6 addresses.
Allow Default Route Override	Allow or disallow the router to override the default route settings when connecting to the ZeroTier network.

### 5.2.6 IP Passthrough

IP Passthrough mode shares or "passes" the Internet providers assigned IP address to a single LAN client device connected to the router.

IP Passthrough

---

**IP Passthrough**

Enable

Network interface SIM1-APN1 v

Passthrough Mode DHCPs-Fixed v

MAC

IP Passthrough	
Item	Description
Enable	Enable or disable IP Passthrough.
Network Interface	Select network interface from SIM1-APN1, SIM1-APN2 and SIM1-APN3.
Passthrough Mode	Select passthrough mode from DHCPs-Fixed and DHCPs-Dynamic.
MAC	Set MAC address.

### 5.2.7 Routing

#### 5.2.7.1 Static Routing

A static routing is a manually configured routing entry. Information about the routing is manually

entered rather than obtained from dynamic routing traffic. After setting static routing, the package for the specified destination will be forwarded to the path designated by user.

Static Routing	RIP	OSPF	Routing Filtering		
Static Routing					
Destination	Netmask/Prefix Length	Interface	Gateway	Distance	Operation
<input type="text" value="114.114.114.114"/>	<input type="text" value="255.255.255.255"/>	<input type="text" value="LAN1/WAN"/>	<input type="text" value="192.168.5.1"/>	<input type="text" value="1"/>	<input type="button" value="✕"/>
<input type="text" value="8.8.8.8"/>	<input type="text" value="255.255.255.255"/>	<input type="text" value="LAN1/WAN"/>	<input type="text" value="192.168.5.1"/>	<input type="text" value="1"/>	<input type="button" value="✕"/>
<input type="text" value="0.0.0.0"/>	<input type="text" value="0.0.0.0"/>	<input type="text" value="LAN1/WAN"/>	<input type="text" value="192.168.5.1"/>	<input type="text" value="1"/>	<input type="button" value="✕"/>
					<input type="button" value="⊕"/>

Static Routing	
Item	Description
Destination	Enter the destination IP address.
Netmask/Prefix Length	Enter the subnet mask or prefix length of destination address.
Interface	The interface through which the data can reach the destination address.
Gateway	IP address of the next router that will be passed by before the input data reaches the destination address.
Distance	Priority, smaller value refers to higher priority. Range: 1-255.

### 5.2.7.2 Priority Based Routing

Policy-based routing (PBR) is a technique used in computer networks to direct network packets based on defined criteria beyond the standard destination-based routing. Unlike traditional routing, which forwards packets solely based on their destination address, PBR allows to customize routing decisions according to various factors. **Policy-based routing takes precedence over static routing.** With policy-based routing you can implement specific rules or policies to dictate the path that packets should take through the network. This flexibility enables organizations to optimize traffic flow, prioritize certain types of traffic, enforce security measures, and manage network resources more efficiently.

Static Routing	Policy Based Routing	RIP	OSPF	Routing Filtering
Priority	Source Subnet	Outgoing Interface	Destination Subnet	Operation
<input type="text" value="1"/>	<input type="text"/>	<input type="text" value="LAN1/WAN"/>	<input type="text"/>	<input type="button" value="✕"/>
				<input type="button" value="⊕"/>

Priority-Based Routing	
Item	Description
Priority	Set the priority of this policy. The smaller the number, the higher the priority. Valid range: 1–255.
Source Subnet	Traffic that matches the specified source subnet will be applied to this

	policy. Leave blank if no source subnet matching is required.
Outgoing Interface	Traffic that matches both the source and destination subnets will be forwarded through the selected interface. Policy routing has higher priority than static routing.
Destination Subnet	Traffic that matches the specified destination subnet will be applied to this policy.
Operation	You can add or delete the policy routing configuration.

## Related Topics

[Cellular](#)

### 5.2.7.3 RIP

RIP is mainly designed for small networks. RIP uses Hop Count to measure the distance to the destination address, which is called Metric. In RIP, the hop count from the router to its directly connected network is 0 and the hop count of network to be reached through a router is 1 and so on. In order to limit the convergence time, the specified metric of RIP is an integer in the range of 0 - 15 and the hop count larger than or equal to 16 is defined as infinity, which means that the destination network or host is unreachable. Because of this limitation, the RIP is not suitable for large-scale networks. To improve performance and prevent routing loops, RIP supports split horizon function. RIP also introduces routing obtained by other routing protocols.

Each router that runs RIP manages a routing database, which contains routing entries to reach all reachable destinations.

**RIP Settings**

Enable

Update Timer  s

Timeout Timer  s

Garbage Collection Timer  s

Version  ▾

Show Advanced Options  Collapse

Default Information Originate

Default Metric

Redistribute Connected

Redistribute Static

Redistribute OSPF

RIP	
Item	Description
Enable	Enable or disable RIP.
Update Timer	It defines the interval to send routing updates. Range: 5-2147483647, in seconds.
Timeout Timer	It defines the routing aging time. If no update package on a routing is received within the aging time, the routing's Routing Cost in the routing table will be set to 16. Range: 5-2147483647, in seconds.
Garbage Collection Timer	It defines the period from the routing cost of a routing becomes 16 to it is deleted from the routing table. In the time of Garbage-Collection, RIP uses 16 as the routing cost for sending routing updates. If Garbage Collection times out and the routing still has not been updated, the routing will be completely removed from the routing table. Range: 5-2147483647, in seconds.
Version	RIP version. The options are v1 and v2.
Advanced Settings	
Default Information Originate	Default information will be released when this function is enabled.
Default Metric	The default cost for the router to reach destination. Range: 0-16
Redistribute Connected	Check to enable.
Metric	Set metric after "Redistribute Connected" is enabled. Range: 0-16.
Redistribute Static	Check to enable.
Metric	Set metric after "Redistribute Static" is enabled. Range: 0-16.
Redistribute OSPF	Check to enable.
Metric	Set metric after "Redistribute OSPF" is enabled. Range: 0-16.

Distance/Metric Management							
Distance	IP Address	Netmask	ACL Name	Operation			
							+
Metric	Policy In/Out	Interface	ACL Name	Operation			
							+
Filter Policy							
Policy Type	Policy Name	Policy In/Out	Interface	Operation			
							+
Passive Interface							
Passive Interface							Operation
							+
Interface							
Interface	Send Version	Receive Version	Split-Horizon	Authentication Mode	Authentication String	Authentication Key-chain	Operation
							+
Neighbor							
IP Address							Operation
							+
Network							
IP Address			Netmask			Operation	
							+

Item	Description
Distance/Metric Management	
Distance	Set the administrative distance that a RIP route learns. Range: 1-255.
IP Address	Set the IP address of RIP route.
Netmask	Set the netmask of RIP route.
ACL Name	Set ACL name of RIP route.
Metric	The metric of received route or sent route from the interface. Range: 0-16.
Policy in/out	Select from "in" and "out".
Interface	Select interface of the route.
ACL Name	Access control list name of the route strategy.
Filter Policy	
Policy Type	Select from "access-list" and "prefix-list".
Policy Name	User-defined prefix-list name.
Policy in/out	Select from "in" and "out".
Interface	Select interface from "cellular0", "LAN1/WAN" and "Bridge0".
Passive Interface	
Passive Interface	Select interface from "cellular0" and "LAN1/WAN", "Bridge0".
Interface	

Interface	Select interface from "cellular0", "LAN1/WAN" and "Bridge0".
Send Version	Select from "default", "v1" and "v2".
Receive Version	Select from "default", "v1" and "v2".
Split-Horizon	Select from "enable" and "disable".
Authentication Mode	Select from "text" and "md5".
Authentication String	The authentication key for package interaction in RIPV2.
Authentication Key-chain	The authentication key-chain for package interaction in RIPV2.
<b>Neighbor</b>	
IP Address	Set RIP neighbor's IP address manually.
<b>Network</b>	
IP Address	The IP address of interface for RIP publishing.
Netmask	The netmask of interface for RIP publishing.

#### 5.2.7.4 OSPF

OSPF, short for Open Shortest Path First, is a link status based on interior gateway protocol developed by IETF.

If a router wants to run the OSPF protocol, there should be a Router ID that can be manually configured. If no Router ID configured, the system will automatically select an IP address of interface as the Router ID. The selection order is as follows:

- If a Loopback interface address is configured, then the last configured IP address of Loopback interface will be used as the Router ID;
- If no Loopback interface address is configured, the system will choose the interface with the biggest IP address as the Router ID.

#### Five types of packets of OSPF:

- **Hello packet**
- **DD packet** (Database Description Packet)
- **LSR packet** (Link-State Request Packet)
- **LSU packet** (Link-State Update Packet)
- **LSAck packet** (Link-Sate Acknowledgment Packet)

#### Neighbor and Neighboring

After OSPF router starts up, it will send out Hello Packets through the OSPF interface. Upon receipt of Hello packet, OSPF router will check the parameters defined in the packet. If it's consistent, a neighbor relationship will be formed. Not all matched sides in neighbor relationship can form the adjacency relationship. It is determined by the network type. Only when both sides successfully exchange DD packets and LSDB synchronization is achieved, the adjacency in the true sense can be formed. LSA describes the network topology around a router, LSDB describes entire network topology.

## | OSPF Settings

Enable	<input type="checkbox"/>
Router ID	<input type="text"/>
ABR Type	<input type="text" value="cisco"/>
RFC1583 Compatibility	<input checked="" type="checkbox"/>
OSPF Opaque-LSA	<input type="checkbox"/>
SPF Delay Time	<input type="text" value="0"/> ms
SPF Initial-holdtime	<input type="text" value="50"/> ms
SPF Max-holdtime	<input type="text" value="5000"/> ms
Reference Bandwidth	<input type="text" value="100"/> mbit

OSPF	
Item	Description
Enable	Enable or disable OSPF.
Router ID	Router ID (IP address) of the originating LSA.
ABR Type	Select from cisco, ibm, standard and shortcut.
RFC1583 Compatibility	Enable/Disable.
OSPF Opaque-LSA	Enable/Disable LSA: a basic communication means of the OSPF routing protocol for the Internet Protocol (IP).
SPF Delay Time	Set the delay time for OSPF SPF calculations. Range: 0-6000000, in milliseconds.
SPF Initial-holdtime	Set the initialization time of OSPF SPF. Range: 0-6000000, in milliseconds.
SPF Max-holdtime	Set the maximum time of OSPF SPF. Range: 0-6000000, in milliseconds.
Reference Bandwidth	Range: 1-4294967, in Mbit.

Interface					
Interface	Hello Interval(s)	Dead Interval(s)	Retransmit Interval(s)	Transmit Delay(s)	Operation
					+

Interface Advanced Options							
⌵ Collapse							
Interface	Network	Cost	Priority	Authentication	Key ID	Key	Operation
							+

Item	Description
<b>Interface</b>	
Interface	Select interface from "cellular0" and "Bridge0".
Hello Interval (s)	Send interval of Hello packet. If the Hello time between two adjacent routers is different, the neighbour relationship cannot be established. Range: 1-65535.
Dead Interval (s)	Dead Time. If no Hello packet is received from the neighbours within the dead time, then the neighbour is considered failed. If dead times of two adjacent routers are different, the neighbour relationship cannot be established.
Retransmit Interval (s)	When the router notifies an LSA to its neighbour, it is required to make acknowledgement. If no acknowledgement packet is received within the retransmission interval, this LSA will be retransmitted to the neighbour. Range: 3-65535.
Transmit Delay (s)	It will take time to transmit OSPF packets on the link. So a certain delay time should be increased before transmission the aging time of LSA. This configuration needs to be further considered on the low-speed link. Range: 1-65535.
<b>Interface Advanced Options</b>	
Interface	Select interface.
Network	Select OSPF network type.
Cost	Set the cost of running OSPF on an interface. Range: 1-65535.
Priority	Set the OSPF priority of interface. Range: 0-255.
Authentication	Set the authentication mode that will be used by the OSPF area. Simple: a simple authentication password should be configured and confirmed again. MD5: MD5 key & password should be configured and confirmed again.
Key ID	It only takes effect when MD5 is selected. Range 1-255.
Key	The authentication key for OSPF packet interaction.

Passive Interface				
Passive Interface				Operation
				+
Network				
IP Address	Netmask	Area ID	Operation	
				+
Neighbor				
IP Address	Priority	Poll	Operation	
				+
Area				
Area ID	Area	No Summary	Authentication	Operation
				+

Item	Description
<b>Passive Interface</b>	
Passive Interface	Select interface from "cellular0" and "Bridge0".
<b>Network</b>	
IP Address	The IP address of local network.
Netmask	The netmask of local network.
Area ID	The area ID of original LSA's router.
<b>Area</b>	
Area ID	Set the ID of the OSPF area (IP address).
Area	Select from "Stub" and "NSSA". The backbone area (area ID 0.0.0.0) cannot be set as "Stub" or "NSSA".
No Summary	Forbid route summarization.
Authentication	Select authentication from "simple" and "md5".

## Area Advanced Options

 Collapse

## Area Range

Area ID	IP	Netmask	No Advertise	Cost	Operation
					

## Area Filter

Area ID	Filter Type	ACL Name	Operation
			

## Area Virtual Link

Area ID	ABR Address	Authentication	Key ID	Key	Hello Interval	Dead Interval	Retransmit Interval	Transmit Delay	Operation
									

## Area Advanced Options

Item	Description
<b>Area Range</b>	
Area ID	The area ID of the interface when it runs OSPF (IP address).
IP Address	Set the IP address.
Netmask	Set the netmask.
No Advertise	Forbid the route information to be advertised among different areas.
Cost	Range: 0-16777215
<b>Area Filter</b>	
Area ID	Select an Area ID for Area Filter.
Filter Type	Select from "import", "export", "filter-in", and "filter-out".
ACL Name	Enter an ACL name which is set on "Routing > Routing Filtering" webpage.
<b>Area Virtual Link</b>	
Area ID	Set the ID number of OSPF area.
ABR Address	ABR is the router connected to multiple outer areas.
Authentication	Select from "simple" and "md5".
Key ID	It only takes effect when MD5 is selected. Range 1-15.
Key	The authentication key for OSPF packet interaction.
Hello Interval	Set the interval time for sending Hello packets through the interface. Range: 1-65535.
Dead Interval	The dead interval time for sending Hello packets through the interface. Range: 1-65535.
Retransmit Interval	The retransmission interval time for re-sending LSA. Range: 1-65535.
Transmit Delay	The delay time for LSA transmission. Range: 1-65535.

**Redistribution**

Redistribution Type	Metric	Metric Type	Route Map	Operation
				+

Redistribution Advanced Options ⌵ Collapse

Always Redistribute Default Route

Redistribute Default Route Metric

Redistribute Default Route Metric Type

Type

**Distance Management**

Area Type	Distance	Operation
		+

Item	Description
<b>Redistribution</b>	
Redistribution Type	Select from "connected", "static" and "rip".
Metric	The metric of redistribution router. Range: 0-16777214.
Metric Type	Select Metric type from "1" and "2".
Route Map	Mainly used to manage route for redistribution.
<b>Redistribution Advanced Options</b>	
Always Redistribute Default Route	Send redistribution default route after starting up.
Redistribute Default Route Metric	Send redistribution default route metric. Range: 0-16777214.
Redistribute Default Route Metric Type	Select from "0", "1" and "2".
<b>Distance Management</b>	
Area Type	Select from "intra-area", "inter-area" and "external".
Distance	Set the OSPF routing distance for area learning. Range: 1-255.

### 5.2.7.5 Routing Filtering

**Access Control List**

Name	Action	Match Any	IP	Netmask	Operation
					+

**IP Prefix-List**

Name	Sequence Number	Action	Match Any	IP	Netmask	GE Length	LE Length	Operation
								+

Routing Filtering	
Item	Description
<b>Access Control List</b>	
Name	User-defined name, need to start with a letter. Only letters, digits and underline (_) are allowed.
Action	Select from "permit" and "deny".
Match Any	No need to set IP address and subnet mask.
IP Address	User-defined.
Netmask	User-defined.
<b>IP Prefix-List</b>	
Name	User-defined name, need to start with a letter. Only letters, digits and underline (_) are allowed.
Sequence Number	A prefix name list can be matched with multiple rules. One rule is matched with one sequence number. Range: 1-4294967295.
Action	Select from "permit" and "deny".
Match Any	No need to set IP address, subnet mask, FE Length, and LE Length.
IP Address	User-defined.
Netmask	User-defined.
FE Length	Specify the minimum number of mask bits that must be matched. Range: 0-32.
LE Length	Specify the maximum number of mask bits that must be matched. Range: 0-32.

### 5.2.8 VRRP

The Virtual Router Redundancy Protocol (VRRP) is a computer networking protocol that provides automatic assignment of available Internet Protocol (IP) routers for participating hosts. This increases the availability and reliability of routing paths via automatic default gateway selections in an IP sub-network.

Increasing the number of exit gateway is a common method for improving system reliability. VRRP adds a group of routers that undertake gateway function into a backup group so as to form a virtual router. The election mechanism of VRRP will decide which router undertakes the forwarding task, and the host in LAN is only required to configure the default gateway for the virtual router.

In VRRP, routers need to be aware of failures in the virtual master router. To achieve this, the virtual master router sends out multicast "alive" announcements to the virtual backup routers in the same VRRP group.

The VRRP router who has the highest number will become the virtual master router. The VRRP router number ranges from 1 to 255 and usually we use 255 for the highest priority and 100 for backup.

If the current virtual master router receives an announcement from a group member (Router ID) with a higher priority, then the latter will pre-empt and become the virtual master router.

VRRP has the following characteristics:

- The virtual router with an IP address is known as the Virtual IP address. For the host in LAN, it is only required to know the IP address of virtual router, and set it as the address of the next hop of the default route.
- The network Host communicates with the external network through this virtual router.

- A router will be selected from the set of routers based on its priority to undertake the gateway function. Other routers will be used as backup routers to perform the duties of gateway for the gateway router in the case of any malfunction, so as to guarantee uninterrupted communication between the host and external network.

When interface connected with the uplink is at the state of Down or Removed, the router actively lowers its priority so that priority of other routers in the backup group will be higher. Thus the router with the highest priority becomes the gateway for the transmission task.

VRRP

**Status** DISABLE

**VRRP Settings**

Enable

Interface Bridge0 ▾

Virtual Router ID 1

Virtual IP

Priority 100

Advertisement Interval (s) 1

Preemption Mode

IPV4 Primary Server 8.8.8.8

IPV4 Secondary Server 223.5.5.5

Interval 300 s

Retry Interval 5 s

Timeout 3 s

Max Ping Retries 3

VRRP		
Item	Description	Default
Enable	Enable or disable VRRP.	Disable
Interface	Select the interface of Virtual Router.	None
Virtual Router ID	User-defined Virtual Router ID. Range: 1-255.	None
Virtual IP	Set the IP address of Virtual Router.	None
Priority	The VRRP priority range is 1-254 (a bigger number indicates a higher priority). The router with higher priority will be more likely to become the gateway router.	100
Advertisement Interval (s)	Heartbeat package transmission time interval between routers in the virtual ip group. Range: 1-255.	1
Preemption Mode	If the router works in the preemption mode, once it finds that its own priority is higher than that of the current gateway router, it will send VRRP notification package, resulting in re-election of gateway router and eventually replacing the original gateway router. Accordingly, the original gateway router will become a Backup router.	Disable

IPV4 Primary Server	The router will send ICMP packet to the IP address or host name to determine whether the Internet connection is still available or not.	8.8.8.8
IPV4 Secondary Server	The router will try to ping the secondary server name if primary server is not available.	223.5.5.5
Interval	Time interval (in seconds) between two Pings.	300
Retry Interval	Set the ping retry interval. When ping failed, the router will ping again every retry interval.	5
Timeout	The maximum amount of time the router will wait for a response to a ping request. If it does not receive a response for the amount of time defined in this field, the ping request will be considered as failure.	3
Max Ping Retries	The retry times of the router sending ping request until determining that the connection has failed.	3

### 5.2.9 DDNS

Dynamic DNS (DDNS) is a method that automatically updates a name server in the Domain Name System, which allows user to alias a dynamic IP address to a static domain name.

DDNS serves as a client tool and needs to coordinate with DDNS server. Before starting configuration, user shall register on a website of proper domain name provider and apply for a domain name.

[DDNS](#)

---

**DDNS Status**

Status -

**DDNS Method List**

Enable

Name

Interface

Interface IP

Service Type

Username

User ID

Password

Server

Server Path

Hostname

Reporting Interval  s

Append IP

Use HTTPS

DDNS	
Item	Description
Enable	Enable/disable DDNS.
Name	Give the DDNS a descriptive name.
Interface	Set interface bundled with the DDNS.
Service Type	Select the DDNS service provider.
Username	Enter the username for DDNS register.
User ID	Enter User ID of the custom DDNS server.
Password	Enter the password for DDNS register.
Server	Enter the name of DDNS server.
Server Path	By default the hostname is appended to the path.
Hostname	Enter the hostname for DDNS.
Reporting Interval	Set the IP reporting interval for the DDNS.
Append IP	Append your current IP to the DDNS server update path.
Use HTTPS	Enable HTTPS for some DDNS providers.

## 5.3 System

This section describes how to configure general settings, such as administration account, access service, system time, common user management, SNMP, AAA, event alarms, etc.

### 5.3.1 General Settings

#### 5.3.1.1 General

General settings include system info and HTTPS certificates.

**System**

Hostname

Web Login Timeout(s)

Encrypting Cleartext Passwords

**HTTPS Certificates**

Certificate

Key

General		
Item	Description	Default
<b>System</b>		
Hostname	User-defined router name which should be start with a letter.	ROUTER

Web Login Timeout (s)	You need to log in again if it times out. Range: 100-3600.	1800
Encrypting Cleartext Passwords	This function will encrypt all of cleartext passwords into ciphertext passwords.	Enable
<b>HTTPS Certificates</b>		
Certificate	Clicking "Browse" button, choose certificate file on the PC, and then click "Import" button to upload the file into router. Clicking "Export" button will export the file to the PC. Clicking "Delete" button will delete the file.	--
Key	Clicking "Browse" button, choose key file on the PC, and then click "Import" button to upload the file into router. Clicking "Export" button will export file to the PC. Click "Delete" button will delete the file.	--

### 5.3.1.2 System Time

This section explains how to set the system time including time zone and time synchronization type.

**Note:** to ensure that the router runs with the correct time, it's recommended that you set the system time when configuring the router.

System Time	
Item	Description
Current Time	Show the current system time.
Autp DST	Enable to use the daylight saving time.
Time Zone	Click the drop down list to select the time zone you are in.
Sync Type	Click the drop down list to select the time synchronization type. <b>Sync with Browser:</b> Synchronize time with browser. <b>Sync with NTP Server:</b> Synchronize time with NTP Server. <b>Set up Manually:</b> configure the time manually. <b>GPS Time Synchronization:</b> Synchronize time with GPS per hour. This is only applicable with GPS version and ensure that GPS is enabled on <b>Service &gt; GPS &gt; GPS</b> .

	<b>Sync with Cellular Operator:</b> Synchronize time with cellular operator. This only works when the device has registered to cellular network.
Sync with Browser	Synchronize time with browser.
Browser Time	Show the current time of browser.
Set up Manually	Manually configure the system time.
GPS Time Synchronization	Synchronize time with GPS.
Primary NTP Server	Enter primary NTP Server's IP address or domain name.
Secondary NTP Server	Enter secondary NTP Server's IP address or domain name.
<b>NTP Server</b>	
Enable NTP Server	NTP client on the network can achieve time synchronization with router after "Enable NTP Server" option is checked.

### 5.3.1.3 Email

SMTP, short for Simple Mail Transfer Protocol, is a TCP/IP protocol used in sending and receiving e-mail. This section describes how to configure email settings and add email groups for alarms and events.

**SMTP Client Settings**

Enable

Sender's Email Address

SMTP Server Address

Username

Password  

Port

Encryption  ▼

<b>SMTP Client Settings</b>	
<b>Item</b>	<b>Description</b>
Enable	Enable or disable SMTP client function.
Email Address	Enter the sender's email account.
Password	Enter the sender's email password.
SMTP Server Address	Enter SMTP server's domain name.
Port	Enter SMTP server port. Range: 1-65535.
Encryption	Select from: None, TLS/SSL, STARTTLS. <b>None:</b> No encryption. The default port is 25. <b>STARTTLS:</b> STARTTLS is a way to take an existing insecure connection and upgrade it to a secure connection by using SSL/TLS. The default port is 587. <b>TLS/SSL:</b> SSL and TLS both provide a way to encrypt a communication channel between two computers (e.g. your

computer and our server). TLS is the successor to SSL and the terms SSL and TLS are used interchangeably unless you're referring to a specific version of the protocol. The default port is 465.

**Email List**

Recipient's Email address	Description	Operation
<input type="text"/>	<input type="text"/>	<span style="color: blue;">✕</span>
		<span style="color: blue;">+</span>

**Email Group List**

Group ID	Description	Recipient's Email address	Operation
<input type="text"/>	<input type="text"/>	<input style="border-bottom: 1px solid #ccc;" type="text"/>	<span style="color: blue;">✕</span>
			<span style="color: blue;">+</span>

Item	Description
<b>Email List</b>	
Recipient's Email Address	Enter the recipient's Email address.
Description	The description of the Email address.
<b>Email Group List</b>	
Group ID	Set number for email group. Range: 1-100.
Description	The description of the Email group.
Recipient's Email address	Select the Email addresses.

## Related Topics

[DI Setting](#)

[Events Setting](#)

## 5.3.2 Phone&SMS

### 5.3.2.1 Phone

Phone settings involve in call/SMS trigger, SMS control and SMS alarm for events.

Phone    SMS

**Phone Number List**

Number	Description	Operation
<input type="text"/>	<input type="text"/>	<input type="button" value="X"/>
<input type="button" value="+"/>		

**Phone Group List**

Group ID	Description	Number	Operation
<input type="text"/>	<input type="text"/>	<input type="text" value=""/>	<input type="button" value="X"/>
<input type="button" value="+"/>			

Phone	
Item	Description
<b>Phone Number List</b>	
Number	Enter the telephone number. Digits, "+" and "-" are allowed.
Description	The description of the telephone number.
<b>Phone Group List</b>	
Group ID	Set number for phone group. Range: 1-100.
Description	The description of the phone group.
Number	Select the phone numbers.

## Related Topic

[Connect on Demand](#)

### 5.3.2.2 SMS

SMS settings involve in remote SMS control, sending SMS and SMS receiving and sending status. Ensure the SMS center number is typed on **Network > Interface > Cellular** page before using SMS features.

**General Setting**

SMS Mode

SMS Remote Control

Authentication Type

Password

Phone Group

SMS Settings	
Item	Description
SMS Mode	Select SMS mode: <b>Text:</b> Pure text mode, mainly used in Europe and America. Technically, it can also be used to send Short Messages in Chinese. When CLI commands will be sent to control the router, Text mode is recommended to choose. <b>PDU:</b> It's the default encoding Mode for mobile phones, which conform to all mobile phones SMS format and can use any character.
SMS Remote Control	Enable/disable SMS Remote Control.
Authentication Type	You can choose "phone number" or "password + phone number". <b>Phone number:</b> only the phone numbers on phone groups support remote control. <b>Password + phone number:</b> only the phone numbers on phone groups support remote control; besides, control SMS should be sent as format password+";"+command content.
Password	Set password for authentication.
Phone Group	Select the Phone group which used for remote control. User can click the Phone Group and set phone number.

**Send SMS**

Phone Number

Content

**Inbox**

From  To  Sender

Sender	Time	Content
<p>&lt; 1 &gt; 10 Go to: <input type="text"/> <input type="button" value="GO"/></p>		

**Outbox**

From  To  Recipient

Recipient	Time	Content	Status
-----------	------	---------	--------

SMS	
Item	Description
<b>Send SMS</b>	
Phone Number	Enter the number to receive the SMS.
Content	SMS content.

Inbox/Outbox	
Sender	SMS sender from outside.
Recipient	SMS recipient which the router send to.
From	Select the start date.
To	Select the end date.
Search	Search for SMS record.
Clear All	Clear all SMS records in web GUI.

### 5.3.3 Power Management

This section will describe how to setup standby settings and wakeup settings.

[Standby Mode](#)

---

**Standby Settings**

Enable

Action Before Standby  SMS  Email  DO

Mode

Duration(\*10ms)

**Wakeup Settings**

Wakeup By Schedule

Wakeup By DI

DI Mode of Wakeup

Duration of DI to Trigger Wakeup (s)

Triggered Type of Standby Again

Duration of DI to Trigger Standby Mode(ms)

Wakeup By Cellular

Wakeup By Ethernet

Wakeup Duration of Ethernet (Min)

Wakeup By Serial

Action After Wakeup  SMS  Email  DO

Mode

Duration(\*10ms)

Enable standby mode and click [Apply], the router will enter standby mode in 10 mins.

Standby Mode	
Item	Description
<b>Standby Settings</b>	
Enable	Enable or disable standby mode.
Action Before Standby	Set the action before the router enters the standby mode. If the settings is enabled, the router will execute the action before entering the standby mode.
SMS	Tick to enable SMS alarm before the router enters the standby mode.
Phone Group	Set phone number to receive SMS alarm.
SMS Content	Fill in the SMS alarm content.
Email	Tick to enable Email alarm before the router enters the

	standby mode.
Email Group	Set email address to receive email alarm.
Email Content	Fill in the email alarm content.
DO	Tick to enable DO before the router enters the standby mode.
Mode	Options include "High Level", "Low Level", and "pulse".
Duration(*10ms)	Set the duration of high/low level in digital input.
Initial Status	Set initial state of DO when pulse mode is selected.
Duration of High Level	Set the duration of pulse's high level.
Duration of Low Level	Set the duration of pulse's low level.
The Number of Pulse	Set the quantity of pulse.
<b>Wakeup Setting</b>	
Wakeup By Schedule	If enabled, the router will be woken up periodically by the schedule when it is on standby mode.
Repeat Mode	Set the repeat mode as hour or day.
Repeat Frequency	Set the repeat frequency for schedule wakeup.
Wakeup Time	Set the time period for the router to wake up. In this time period, the router will be waken up and work. <b>Example:</b> current time is 0:30. when weakup time is set to 0:00 to 0:10, router will weak up during 1:00 to 1:10, 2:00 to 2:10 until repeat frequency reaches.
Wakeup By DI	If enabled, when the router is in standby mode and receives DI, the router will wake up from standby mode and turn to working mode.
DI Mode of Wakeup	Set the DI mode to wake up router from standby mode.
Duration of DI to Trigger Wakeup	Set the DI duration to wake up router from standby mode.
Triggered Type of Standby Again	Set the trigger type to trigger the router to enter standby mode again after being woken up by DI. <b>DI:</b> when router receives a DI signal which is opposite to "DI Mode of Wakeup" and satisfies the "DI Duration of Standby", the router will enter standby mode immediately. <b>Time:</b> the router will enter the standby mode again after reaching the wake-up duration.
DI Duration of Standby	Set the DI duration for the router to enter standby mode again after being woken up by DI.
Wakeup Duration of DI	Set the duration of entering standby mode again after the router is woken up by DI from standby mode to operation mode.
Wakeup By Cellular	The router will be woken up when cellular receives SMS or call and switch from standby mode to working mode. Ensure that the router has registered to cellular network before standby.

Call Group	Select a call group for cellular wakeup. Go to "System > Phone & SMS > Phone" to set up the phone group.
SMS Group	Select a SMS group for cellular wakeup. Go to "System > Phone & SMS > Phone" to set up the phone group.
SMS Text	Fill in the SMS content for wakeup.
Wakeup Duration of Cellular	Set the duration of entering standby mode again after the router is woken up by cellular.
Wakeup By Ethernet	The router will be woken up when Ethernet interface receives a special frame (E8:E8:B7:07:FB:BD).
Wakeup Duration of Ethernet	Set the duration of entering standby mode again after the router is woken up by Ethernet.
Wakeup By Serial	The router will be woken up when serial port receives a 1-byte data packet. <b>Note:</b> the serial device need to send 1-byte wake-up data before sending normal data.
Wakeup Duration of Serial	Set the duration of entering standby mode again after the router is woken up by serial.
Action After Wakeup	Set the action after the router wakes up.
SMS	Enable SMS alarm after the router wakes up.
Email	Enable Email alarm after the router wakes up.
DO	Enable to trigger DO after the router wakes up.

**Note:**

1. When standby mode is enabled, press and hold on reset button for 3s to weak up router for 1 hour.
2. If multiple weakup conditions are enabled, the router will only execute the maximum weakup duration.

**5.3.4 User Management****5.3.4.1 Account**

Here you can change the login username and password of the administrator.

**Note:** it is strongly recommended that you modify them for the sake of security.

Account
User Management

| Change Account Info

Username	<input style="width: 90%;" type="text" value="admin"/>
Old Password	<input style="width: 90%;" type="password"/>
New Password	<input style="width: 90%;" type="password"/>
Confirm New Password	<input style="width: 90%;" type="password"/>

Account	
Item	Description
Username	Enter a new username. You can use characters such as a-z, 0-9, "_", "-". The first character can't be a digit.
Old Password	Enter the old password.
New Password	Enter a new password. You can use any ASCII characters except blank. The password must contain at least one letter and one number, with a length of 5-31 characters.
Confirm New Password	Enter the new password again.

### 5.3.4.2 User Management

This section describes how to create common user accounts. The common user permission includes Read-Only and Read-Write.

The screenshot shows a web interface for 'User Management'. At the top, there are tabs for 'Account' and 'User Management'. Below the tabs is a 'User List' section. The form contains three input fields: 'Username', 'Password', and 'Permission'. The 'Permission' dropdown menu is currently set to 'Read-Only'. To the right of the form is an 'Operation' column with a blue 'X' icon and a blue '+' icon.

User Management	
Item	Description
Username	Enter a new username. Only lowercase letters, digits, "_", "-" are allowed. The first character can't be a digit.
Password	Set password. You can use any ASCII characters except blank. The password must contain at least one letter and one number, with a length of 5-31 characters.
Permission	Select user permission from "Read-Only" and "Read-Write". <b>Read-Only:</b> users can only view the configuration of router in this level. <b>Read-Write:</b> users can view and set the configuration of router in this level.

### 5.3.5 AAA

AAA access control is used for visitors control and the available corresponding services once access is allowed. It adopts the same method to configure three independent safety functions. It provides modularization methods for following services:

- Authentication: verify if the user is qualified to access to the network.
- Authorization: authorize related services available for the user.
- Charging: record the utilization of network resources.

#### 5.3.5.1 Radius

Using UDP for its transport, Radius is generally applied in various network environments with higher requirements of security and permission of remote user access.

Radius	Tacacs+	LDAP	Authentication
<b>Radius Settings</b>			
Enable	<input type="checkbox"/>		
Server IP Address	<input type="text"/>		
Server Port	<input type="text" value="1812"/>		
Shared Secret	<input type="text"/>		
<input type="button" value="Save"/>			

Radius	
Item	Description
Enable	Enable or disable Radius.
Server IP Address	Fill in the Radius server IP address/domain name.
Server Port	Fill in the Radius server port. Range: 1-65535.
Key	Fill in the key consistent with that of Radius server in order to get connected with Radius server.

### 5.3.5.2 TACACS+

Using TCP for its transport, TACACS+ is mainly used for authentication, authorization and charging of the access users and terminal users by adopting PPP and VPDN.

Radius	Tacacs+	LDAP	Authentication
<b>Tacacs+ Settings</b>			
Enable	<input checked="" type="checkbox"/>		
Server IP Address	<input type="text"/>		
Server Port	<input type="text" value="49"/>		
Shared Secret	<input type="text"/>		
<input type="button" value="Save"/>			

TACACS+	
Item	Description
Enable	Enable or disable TACACS+.
Server IP Address	Fill in the TACACS+ server IP address/domain name.
Server Port	Fill in the TACACS+ server port. Range: 1-65535.
Key	Fill in the key consistent with that of TACACS+ server in order to get connected with TACACS+ server.

### 5.3.5.3 LDAP

A common usage of LDAP is to provide a central place to store usernames and passwords. This allows many different applications and services to connect the LDAP server to validate users.

LDAP is based on a simpler subset of the standards contained within the X.500 standard. Because of this relationship, LDAP is sometimes called X.500-lite as well.

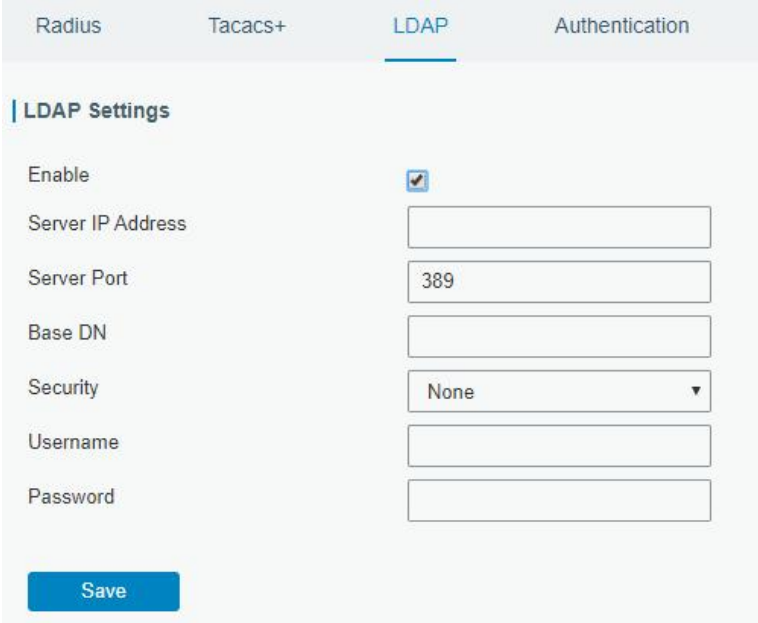

LDAP	
Item	Description
Enable	Enable or Disable LDAP.
Server IP Address	Fill in the LDAP server's IP address/domain name. The maximum count is 10.
Server Port	Fill in the LDAP server's port. Range: 1-65535
Base DN	The top of LDAP directory tree.
Security	Select secure method from "None", "StartTLS" and "SSL".
Username	Enter the username to access the server.
Password	Enter the password to access the server.

### 5.3.5.4 Authentication

AAA supports the following authentication ways:

- None: uses no authentication, generally not recommended.
- Local: uses the local username database for authentication.
  - Advantages: rapidness, cost reduction.
  - Disadvantages: storage capacity limited by hardware.
- Remote: has user's information stored on authentication server. Radius, TACACS+ and LDAP supported for remote authentication.

When radius, TACACS+, and local are configured at the same time, the priority level is: 1 >2 >3.

Radius    Tacacs+    LDAP    Authentication

**Authentication Settings**

Service	1	2	3
Console	None ▾	None ▾	None ▾
Web	None ▾	None ▾	None ▾
Telnet	None ▾	None ▾	None ▾
SSH	None ▾	None ▾	None ▾

[Save](#)

Authentication	
Item	Description
Console	Select authentication for Console access.
Web	Select authentication for Web access.
Telnet	Select authentication for Telnet access.
SSH	Select authentication for SSH access.

## 5.3.6 Device Management

### 5.3.6.1 Auto Provision

When Auto Provision is enabled and the device is connected to Internet, the device will receive the configuration profile to achieve initial configuration by Milesight Development Platform. This feature will work even the device does not configure to connect Milesight Development Platform.

**Auto Provision**

Enable

Status Disabled

### 5.3.6.2 DeviceHub

You can choose which platform you want to connect on this page so as to manage the router centrally and remotely: Milesight DeviceHub and Milesight Development Platform. For more details please refer to corresponding platform manuals.

**Device Management**

Enable

Platform Type DeviceHub ▾

Server Address

Activation Method By Authentication Code ▾

Authentication Code

Status Not enabled

Device Management	
Item	Description
Enable	Enable or disable to connect router to management platform.
Platform Type	DeviceHub and Milesight Development Platform are optional.
Status	Show the connection status between the router and the platform.
DeviceHub	
Server Address	IP address or domain of the device management server.
Activation Method	Select activation method to connect the router to the DeviceHub server, options are "By Authentication Code" and "By Account name".
Authentication Code	Fill in the authentication code generated from the DeviceHub.
Account name	Fill in the registered DeviceHub account (email) and password.
Password	

### 5.3.6.3 Milesight VPN

You can connect the device to the Milesight VPN on this page so as to manage the router and connected devices centrally and remotely. For more details please refer to **MilesightVPN User Guide**.

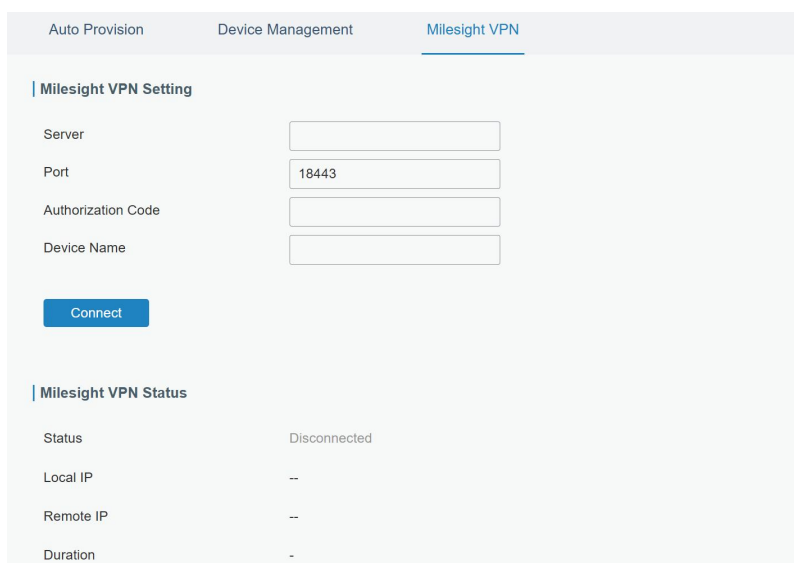

Milesight VPN	
Item	Description
Milesight VPN Settings	
Server	Enter the IP address or domain name of Milesight VPN.
Port	Enter the HTTPS port number.
Authorization code	Enter the authorization code which generated by Milesight VPN.
Device Name	Enter the name of the device.
Milesight VPN Status	
Status	Show the connection information about whether the router is connected to the Milesight VPN.
Local IP	Show the virtual IP of the router.

Remote IP	Show the virtual IP of the Milesight VPN.
Duration	Show the information on how long the router has been connected to the Milesight VPN.

### 5.3.7 Events

Event feature is capable of sending alerts by Email when certain system events occur.

#### 5.3.7.1 Events

You can view alarm messages on this page.

Events	
Item	Description
Mark as Read	Mark the selected event alarm as read.
Delete	Delete the selected event alarm.
Mark All as Read	Mark all event alarms as read.
Delete All Alarms	Delete all event alarms.
Status	Show the reading status of the event alarms, such as “Read” and “Unread”.
Type	Show the event type that should be alarmed.
Time	Show the alarm time.
Message	Show the alarm content.
Unread	The event alarm is unread.
Read	The event alarm is read.

#### 5.3.7.2 Events Settings

In this section, you can decide what events to record and whether you want to receive email and SMS notifications when any change occurs.

Events
Events Settings

---

**Events Settings**

Enable

Phone Group List

Email Group List

Events	Record <input checked="" type="checkbox"/>	Email <input type="checkbox"/> Email Group List	SMS <input type="checkbox"/> Phone Group List	SNMP <input type="checkbox"/>
System Startup	<input checked="" type="checkbox"/>	<input type="checkbox"/>	<input type="checkbox"/>	<input type="checkbox"/>
System Reboot	<input checked="" type="checkbox"/>	<input type="checkbox"/>	<input type="checkbox"/>	<input type="checkbox"/>
System Time Update	<input checked="" type="checkbox"/>	<input type="checkbox"/>	<input type="checkbox"/>	<input type="checkbox"/>
VPN Up	<input checked="" type="checkbox"/>	<input type="checkbox"/>	<input type="checkbox"/>	<input type="checkbox"/>
VPN Down	<input checked="" type="checkbox"/>	<input type="checkbox"/>	<input type="checkbox"/>	<input type="checkbox"/>
Weak Signal	<input checked="" type="checkbox"/>	<input type="checkbox"/>	<input type="checkbox"/>	<input type="checkbox"/>
Cellular Up	<input checked="" type="checkbox"/>	<input type="checkbox"/>	<input type="checkbox"/>	<input type="checkbox"/>
Cellular Down	<input checked="" type="checkbox"/>	<input type="checkbox"/>	<input type="checkbox"/>	<input type="checkbox"/>
Cellular Data Stats Clear	<input checked="" type="checkbox"/>	<input type="checkbox"/>	<input type="checkbox"/>	<input type="checkbox"/>
Cellular Data Traffic is running out	<input checked="" type="checkbox"/>	<input type="checkbox"/>	<input type="checkbox"/>	<input type="checkbox"/>
Cellular Data Traffic Overflow	<input checked="" type="checkbox"/>	<input type="checkbox"/>	<input type="checkbox"/>	<input type="checkbox"/>
Router Starts Standby	<input checked="" type="checkbox"/>	<input type="checkbox"/>	<input type="checkbox"/>	<input type="checkbox"/>
Wake Up Router	<input checked="" type="checkbox"/>	<input type="checkbox"/>	<input type="checkbox"/>	<input type="checkbox"/>
Connect to UPS External Power Supplies	<input type="checkbox"/>	<input type="checkbox"/>	<input type="checkbox"/>	<input type="checkbox"/>
Connect to UPS Internal Battery	<input type="checkbox"/>	<input type="checkbox"/>	<input type="checkbox"/>	<input type="checkbox"/>
UPS Low Power (20%)	<input type="checkbox"/>	<input type="checkbox"/>	<input type="checkbox"/>	<input type="checkbox"/>
UPS Abnormal Charging	<input type="checkbox"/>	<input type="checkbox"/>	<input type="checkbox"/>	<input type="checkbox"/>
Disconnect the UPS	<input type="checkbox"/>	<input type="checkbox"/>	<input type="checkbox"/>	<input type="checkbox"/>

Event Settings	
Item	Description
Enable	Enable events settings.
Phone Group List	Select phone group to receive SMS alarm.
Email Group List	Select email group to receive alarm.
Events	The name of alarm events.
Record	The relevant content of event alarm will be recorded on <b>Event</b> page if this option is checked.

Email	The relevant content of event alarm will be sent out via email if this option is checked.
Email Setting	Click and you will be redirected to the page <b>Email</b> to configure email group list.
SNMP	The relevant content of event alarm will be sent out via SNMP Trap if this option is checked.
SMS	The relevant content of event alarm will be sent out via SMS if this option is checked.
SMS Setting	Click and you will be redirected to the page of <b>Phone</b> to configure phone group list.

## Related Topics

### [Email Setting](#)

MQTT

Enable

Events	MQTT	Topic	Retain Flag	QoS	Operation
<input type="text"/>	<input type="text"/>	<input type="text"/>	<input type="checkbox"/>	Qos 0 <input type="text"/>	<input type="button" value="x"/>
<input type="button" value="+"/>					

MQTT	
Item	Description
Enable	If enabled, MQTT forwarding is performed when an event is triggered.
Events	Select the type of event that needs to be MQTT forwarded.
MQTT	Select the MQTT connection used for forwarding the current event type.
Topic	Define the topic name of the forwarding event, which is used by the router to forward data when the event is triggered.
Retain Flag	Enable to set the latest message of this topic as retain message.
QoS	<p><b>QoS 0</b> - Only Once This is the fastest method and requires only 1 message. It is also the most unreliable transfer mode.</p> <p><b>QoS 1</b> - At Least Once This level guarantees that the message will be delivered at least once, but may be delivered more than once.</p> <p><b>QoS 2</b> - Exactly Once QoS 2 is the highest level of service in MQTT. This level guarantees that each message is received only once by the intended recipients. QoS 2 is the safest and slowest quality of service level.</p>

## 5.4 Service

### 5.4.1 I/O

#### 5.4.1.1 DI

This section explains how to configure monitoring condition on digital input, and take certain actions once the condition is reached.

**DI Setting**

Enable

Mode

Duration(ms)

Action  SMS  Email  DO  Cellular UP  MQTT  SNMP

DI	
Item	Description
Enable	Enable or disable DI.
Mode	Options are High Level, Low Level, Counter and Level Change.
Duration (ms)	Set the duration of high/low level in digital input. Range: 1-10000.
Condition	Select the condition to trigger the counter. <b>Low-&gt;High:</b> The counter value will increase by 1 if digital input's status changes from low level to high level. <b>High-&gt;Low:</b> The counter value will increase by 1 if digital input's status changes from high level to low level.
Counter	The system will take actions accordingly when the counter value reach the preset one, and then reset the counter value to 0. Range: 1-100.
Action	Select the corresponding actions that the system will take when digital input mode meets the preset condition or duration. <b>SMS:</b> enable to send SMS alarms. <b>Email:</b> enable to send Email alarms. <b>DO:</b> control the DO status as settings on <b>Service &gt; I/O &gt; DO page</b> . <b>Cellular UP:</b> Trigger the router to switch from offline to register to cellular network. <b>MQTT:</b> enable to send message to MQTT broker. The MQTT connection is set up on <b>Service &gt; MQTT</b> page. <b>SNMP:</b> enable to report DI events via SNMP Trap. The SNMP parameters is set up on <b>Service &gt; SNMP</b> page.

### Related Topics

[DO Setting](#)

[Email Setting](#)

[Connect on Demand](#)

### 5.4.1.2 DO

This section describes how to configure digital output mode.

DO	
Item	Description
Enable	Enable or disable DO.
Mode	Select the working mode of DO. <b>High Level:</b> trigger the DO to send high level signal. <b>Low Level:</b> trigger the DO to send low level signal. <b>Pulse:</b> trigger the DO to send pulses. <b>Custom:</b> trigger the DO via SMS on the phone group.
Initial Status	Select the initial status of DO when mode is Custom or Pulse. It is also the initial status when the router restarts.
Duration (*10ms)	When mode is high level or low level, set duration of high/low level on digital output. Range: 1-10000.
Duration of High Level (*10ms)	Set the duration of pulse's high level. Range: 1-10000.
Duration of Low Level (*10ms)	Set the duration of pulse's low level. Range: 1-10000.
The Number of Pulse	Set the quantity of pulse. Range: 1-100.
Phone Group	Select phone group which will be used for I/O configuration. User can click the Phone Group and set phone number.

### Related Topics

[DI Setting](#)

### 5.4.2 Serial Port

This section explains how to configure serial port parameters to achieve communication with serial terminals, and configure work mode to achieve communication with the remote data center, so as to achieve two-way communication between serial terminals and remote data center.

Serial

**Serial Settings**

Enable

Serial Type

Baud Rate

Data Bits

Stop Bits

Parity

Software Flow Control

Serial Mode

Serial Settings	
Item	Description
Enable	Enable or disable serial port function.
Serial Type	RS232 or RS485 is optional.
Baud Rate	Range is 300-230400. Same with the baud rate of the connected terminal device.
Data Bits	Options are 8 and 7. Same with the data bits of the connected terminal device.
Stop Bits	Options are 1 and 2. Same with the stop bits of the connected terminal device.
Parity	Options are None, Odd and Even. Same with the parity of the connected terminal device.
Software Flow Control	Enable or disable software flow control.
Serial Mode	<p>Select work mode of the serial port.</p> <p><b>DTU Mode:</b> the serial port can establish communication with the remote server/client.</p> <p><b>GPS(UR41 Only):</b> go to <b>Service &gt; GPS &gt; GPS Serial Forwarding</b> to configure basic parameters to send GPS data to serial port.</p> <p><b>Modbus Client:</b> go to <b>Service &gt; Modbus Client</b> to configure basic parameters and channels.</p> <p><b>Modbus Server:</b> go to <b>Service &gt; Modbus Server</b> to configure basic parameters.</p> <p><b>DLMS Connection:</b> go to <b>Service &gt; DLMS</b> to configure basic parameters.</p>

Serial Mode	<input type="text" value="DTU Mode"/>
DTU Protocol	<input type="text" value="Transparent"/>
Protocol	<input type="text" value="TCP"/>
Keepalive Interval	<input type="text" value="75"/> s
Keepalive Retry Times	<input type="text" value="9"/>
Packet Size	<input type="text" value="1024"/> Bytes
Serial Frame Interval	<input type="text" value="100"/> ms
Reconnect Interval	<input type="text" value="10"/> s
Specific Protocol	<input type="checkbox"/>
Register String	<input type="text"/>

Destination IP Address

Server Address	Server Port	Status	Operation
			<a href="#">+</a>

### DTU Mode

Item	Description	Default
DTU Protocol	Select from below protocols: <b>Transparent:</b> the router is used as TCP/UDP client and transmits data to server transparently. <b>TCP server:</b> the router is used as TCP server to wait for polling data. <b>UDP server:</b> the router is used as UDP server to wait for polling data. <b>Modbus:</b> the router will be used as Modbus gateway, which can achieve conversion between Modbus RTU and Modbus TCP. <b>MQTT:</b> the router will be used as MQTT client to send data to MQTT broker.	--

### TCP/UDP Server

Listening port	Set the router listening port. Range: 1-65535.	502
Keepalive Interval	After TCP connection is established, client will send heartbeat packet regularly by TCP to keep alive. The interval range is 1-3600s.	75
Keepalive Retry Times	When TCP heartbeat times out, router will resend heartbeat. After it reaches the preset retry times, TCP connection will be reestablished. The retry times range is 1-16.	9
Packet Size	Set the size of the serial data frame. Packet will be sent out when preset frame size is reached. The size range is 1-1024 bytes.	1024
Serial Frame Interval	The interval that the router sends out real serial data stored in the buffer area to public network. The range is 10-65535 ms. <b>Note:</b> data will be sent out to public network when real serial data size reaches the preset packet size, even though it's within the serial frame interval.	100

Item	Description	Default
<b>Transparent</b>		
Protocol	Select TCP or UDP protocol.	TCP
Keepalive Interval	After TCP client is connected with TCP server, the client will send	75

(s)	heartbeat packet by TCP regularly to keep alive. The interval range is 1-3600s.	
Keepalive Retry Times	When TCP heartbeat times out, the router will resend heartbeat. After it reaches the preset retry times, router will reconnect to TCP server. The range is 1-16.	9
Packet Size	Set the size of the serial data frame. Packet will be sent out when preset frame size is reached. The range is 1-1024 bytes.	1024
Serial Frame Interval	The interval that the router sends out real serial data stored in the buffer area to public network. The range is 10-65535 ms. <b>Note:</b> data will be sent out to public network when real serial data size reaches the preset packet size, even though it's within the serial frame interval.	100
Reconnect Interval	After connection failure, router will reconnect to the server at the preset interval, in seconds. The range is 10-60s.	10
Specific Protocol	By Specific Protocol, the router will be able to connect to the TCP2COM software.	--
Heartbeat Interval	By Specific Protocol, the router will send heartbeat packet to the server regularly to keep alive. The interval range is 1-3600s.	30
ID	Define unique ID of each router. No longer than 63 characters without space character.	--
Register String	Define register string for connection with the server.	Null
Server Address	Fill in the TCP or UDP server address (IP/domain name).	Null
Server Port	Fill in the TCP or UDP server port. Range: 1-65535.	Null
Status	Show the connection status between the router and the server.	--
<b>Modbus</b>		
Local Port	Set the router listening port. Range: 1-65535.	502
Maximum TCP Clients	Specify the maximum number of TCP clients allowed to connect the router which act as a TCP server.	32
Connection Timeout	If the TCP server does not receive any data from the slave device within the connection timeout period, the TCP connection will be broken.	60
Reading Interval	Set the interval for reading remote channels. When a read cycle ends, the new read cycle begins until this interval expires. If it is set to 0, the device will restart the new read cycle after all channels have been read.	100
Response Timeout	Set the maximum response time that the router waits for the response to the command. If the device does not get a response after the maximum response time, it's determined that the command has timed out.	3000
Maximum Retries	Set the maximum retry times after it fails to read.	3
<b>MQTT</b>		
Packet Size	Set the size of the serial data frame. Packet will be sent out when preset frame size is reached. The range is 1-1024 bytes.	1024
Serial Frame	The interval that the router sends out real serial data stored in the	100

Interval	buffer area to public network. The range is 10-65535 ms. <b>Note:</b> data will be sent out to public network when real serial data size reaches the preset packet size, even though it's within the serial frame interval.	
MQTT Connection	Select the MQTT connection to send serial port data, it's set up on <b>Service &gt; MQTT</b> page.	Null
Type	Select Uplink or Downlink for this transparent. Every type supports to add 10 connections at most.	Null
Topic	Topic name used for publishing serial port data.	Null
Retain	Enable to set the latest message of this topic as retain message.	Null
QoS	QoS0, QoS1 or QoS2 are optional.	Null

## Related Configuration Example

[DTU Application Example](#)

### 5.4.3 Modbus Server (Slave)

This section describes how to achieve I/O status via Modbus TCP, Modbus RTU and Modbus RTU over TCP.

#### 5.4.3.1 Modbus TCP

You can define the address of the DI and DO ports so as to poll DI's status and control DO's status via Modbus TCP protocol.

Modbus TCP
Modbus RTU
Modbus RTU Over TCP

**Modbus TCP**

Enable

Port

DI Address

DO Address

Save

Modbus TCP		
Item	Description	Default
Enable	Enable/disable Modbus TCP.	Disable
Port	Set the router listening port. Range: 1-65535.	502

DI Address	Define the address of DI, range: 0-255.	0
DO Address	Define the address of DO, range: 0, 2-255.	0

### 5.4.3.2 Modbus RTU

You can define the address of the DI and DO ports so as to poll DI's status and control DO's status via Modbus RTU protocol.

Modbus TCP
Modbus RTU
Modbus RTU Over TCP

**Modbus RTU**

Enable

Serial Port

Server ID

DI Address

DO Address

DO\_2 Address

[Save](#)

Modbus RTU		
Item	Description	Default
Enable	Enable/disable Modbus RTU.	Disable
Serial Port	Select the corresponding serial port.	serial
Server ID	Set server ID is used for distinguishing different devices on the same link.	1
DI Address	Define the address of DI, range: 0-255.	0
DO Address	Define the address of DO, range: 0, 2-255.	0

### 5.4.3.3 Modbus RTU Over TCP

You can define the address of the DI and DO ports so as to poll DI's status and control DO's status via Modbus RTU over TCP.

**Modbus RTU Over TCP**

Enable

Server ID

Device ID

Reconnect Interval  s

DI Address

DO Address

Server List

IP	Port	Status	Operation
			<a href="#">+</a>

Modbus RTU Over TCP		
Item	Description	Default
Enable	Enable/disable Modbus RTU over TCP function.	Disable
Server ID	Set server ID is used for distinguishing different devices on the same link.	1
Device ID	Set device ID. The server will get the device ID to the server for identifying identity so that the server can manage multiple devices.	--
Reconnection Interval	The reconnection interval when the device and the server fails to establish connection or disconnected.	10
DI Address	Define the address of DI, range: 0-255.	0
DO Address	Define the address of DO, range: 0, 2-255.	0
Server List		
IP	Enter the IP address of the server.	
Port	Enter the port of the server.Range: 0-65535.	
Status	Show the connection status between the router and the server.	

#### 5.4.4 Modbus Client (Master)

The router can be set as Modbus Client to poll the remote Modbus Server and send alarm according to the response.

##### 5.4.4.1 Modbus Client

**Modbus Client Setting**

Enable

Read Interval  s

Max. Retries

Max. Response Time  ms

Execution Interval  ms

Channel Name

---

**Reset Modbus Client**

Modbus Client		
Item	Description	Default
Enable	Enable/disable Modbus client.	--
Read Interval/s	Set the interval for reading remote channels. When the read cycle ends, the commands which haven't been sent out will be discard, and the new read cycle begins. If it is set to 0, the device will restart the new read cycle after all channels have been read. Range: 0-600.	300
Max. Retries	Set the maximum retry times after it fails to read, range: 0-5.	3
Max. Response Time/ms	Set the maximum response time that the router waits for the response to the command. If the device does not get a response after the maximum response time, it's determined that the command has timed out. Range: 10-1000.	500
Execution Interval/ms	The execution interval between each command. Range: 10-1000.	50
Channel Name	Select a readable channel form the channel list.	--
Reset Modbus Client		
Reset	Clear all configurations of the Modbus Client.	--

#### 5.4.4.2 Channel Settings

On this page, you can add channels and configure the client parameters , so as to connect the router to the remote Modbus Server and execute the read/write function.

Channel Settings

<input type="checkbox"/>	Name	Link	Type	Data Type	Register Address	Read Value Count / Write Value(s)	Operation
No matching records found							

Channel Setting	
Item	Description
Add	Add a single Modbus channel.
Batch Delete	Delete multiple selected Modbus channels in bulk.
Export	Export all added Modbus channels as a table.
Import	Batch-add Modbus channels using a CSV file.

**Add**

Name

Link

Server ID

IP Address

Port

Type

Data Type

Sign

Byte Order

Register Address

Write Value(s)

Read Value Count

Decimal Place

Test Connection

Add	
Item	Description
Name	Set the name to identify the remote channel. It cannot be blank.
Link	Select serial port or TCP connection. <b>Serial Port:</b> the router communicates with devices via Modbus RTU protocol. <b>TCP:</b> the router communicates with devices via Modbus TCP protocol.
Server ID	Set Modbus server ID.
IP address	When link is TCP, fill in the IP address of the remote Modbus TCP device.
Port	When link is TCP, fill in the port of the remote Modbus TCP device.
Type	Select the Modbus function to execute, including read or write commands. Options are Read Coils, Read Discrete Inputs, Read Holding Registers

	Read Input Registers, Write Single Coil, Write Single Holding Register Write Multiple Coils, Write Multiple Holding Registers.
Data Type	Data type used during read or write operations. Options are INT16, INT32, INT64, Float32, Float64, ASCII, HEX
Sign	When type is holding register or input register, enable or disable to identify whether this channel is signed.
Byte Order	Order of storage or transmission of multibyte data. Big-Endian: AB, ABCD, ABCDEFGH; Little-Endian: BA, CDAB, GHEFCADB; Mixed-Endian: BADC, DCBA, HGFEDCBA, BADCFEFG
Register Address	The starting register address for read operations, or the target register address for write operations.
Write Value(s)	The actual value(s) to be written into the register. Values must comply with rules of the selected data type. Multiple values are separated by commas. Rules for different data types: <ul style="list-style-type: none"> <li>● INT16, INT32, INT64: Integer values, within the valid range of the data type. Maximum count: 123 / 61 / 30 values.</li> <li>● Float32, Float64: Floating-point numbers, scientific notation supported. Maximum count: 61 / 30 values.</li> <li>● BOOL: Only 0 or 1 allowed. Maximum count: 123 values.</li> <li>● ASCII: Any ASCII character except space, ";", "(" mark. Values do not need separate by commas. Maximum: 246 characters.</li> <li>● HEX: Four-digit hexadecimal values 0000 - FFFF. Maximum count: 123 values.</li> </ul>
Read Value Count	Number of values to read when executing a read command. Maximum supported values: <ul style="list-style-type: none"> <li>● INT16, ASCII, HEX, BOOL: 125</li> <li>● INT32, Float32: 62</li> <li>● INT64, Float64: 31</li> </ul>
Decimal Place	When type is holding register or input register, indicate a dot in the read into the position of the channel. For example: read the channel value is 1234 and a Decimal Place is equal to 2, then the actual value is 12.34.
Test Connection	Sends a Modbus request to the remote device to verify whether the link and parameters are valid. If the request fails, will return an error code and description.

### 5.4.4.3 Alarm Settings

On this page, you can configure the alarm settings. If the read Modbus values meets the specified condition, the device performs a user-specified action, for example, sending a alarm content or a Modbus write request.

Alarm Settings				
Read Channel Name	Condition	Alarm Action	Write Channel Name	Operation
No matching records found				

Channel Setting	
Item	Description
Add	Add a single Alarm.
Batch Delete	Delete multiple selected Alarms in bulk.
Export	Export all added Alarms as a CSV file.
Import	Batch-add Alarms using a CSV file.

**Add** ✕

Read Channel Name

Condition Type

Min. Threshold

Alarm Action  SMS  Email

SMS Group

Email Group

Normal Content 

Note: \$YEAR/\$MON/\$DAY \$TIME, get NORMAL data \$VALUE from address \$ADDRESS of channel \$NAME. (Abnormal scope is \$CONDITION)

Abnormal Content 

Note: \$YEAR/\$MON/\$DAY \$TIME, get ABERRANT data \$VALUE from address \$ADDRESS of channel \$NAME. (Abnormal scope is \$CONDITION)

Continuous Alarm

Write Channel Name

Add	
Item	Description
Read Channel Name	Name of the channel to be read. Only channels configured with a read function code can be selected.
Condition	The condition that triggers alert.
Min. Threshold	Set the min. value to trigger the alert. When the actual value is less than this value, the alarm will be triggered.
Max. Threshold	Set the max. value to trigger the alert. When the actual value is more than this value, the alarm will be triggered.
Alarm	Select the alarm method as SMS or Email.
SMS	The preset alarm content will be sent to the specified phone number.
Phone Group	Select the phone group to receive the alarm SMS.
Email Group	Select the Email group to receive the alarm Email.
Normal Content	When the actual value is restored to the normal value from exceeding the threshold value, the router will automatically cancel the abnormal alarm and send the preset normal content to the specified phone group.
Abnormal	When the actual value exceeds the preset threshold, the router will

Content	automatically trigger the alarm and send the preset abnormal content to the specified phone group.
Continuous Alarm	Once it is enabled, the same alarm will be continuously reported. Otherwise, the same alarm will be reported only one time.
Write Channel Name	Name of the channel to be written when an alarm is triggered. Only channels configured with a write function code can be selected.

#### 5.4.4.4 Data Forwarding

UR32 router supports MQTT forwarding and TCP forwarding.

The MQTT forwarding function is used to transfer Modbus data (send requests, receive responses) over MQTT. When it is enabled, the router subscribes to a REQUEST topic and publishes on a RESPONSE topic on a specified MQTT broker. It translates received MQTT message payload to a Modbus request and relays it to the specified Modbus server.



**Add**

MQTT Connection

Request Topic  ⓘ

Publish/Response Topic  ⓘ

Read Channel Name

QoS

Retain Flag

Add	
Item	Description
MQTT Connections	Select the MQTT connection to send Modbus channel data, it's set up on <b>Service &gt; MQTT</b> page.
Request Topic	Topic name used for receiving Modbus channel data.
Publish/Response Topic	Topic name used for publishing Modbus channel data or responding to requests.
Read Channel Name	Name of the channel to be read. Only channels configured with a read function code can be selected.
QoS	QoS0, QoS1 or QoS2 are optional.
Retain	Enable to set the latest message of this topic as retain message.

When TCP forwarding is enabled, router reads the register data from the specified channel and forwards it to the designated TCP server.

TCP Forwarding

<input type="checkbox"/>	Name	IP	Port	Operation
No matching records found				

**Add**

Name

IP

Port

Add	
Item	Description
Name	The name of Modbus Client's channel.
IP	The IP address of the server which the packets are forwarded to.
Port	The port of the server's which the packets are forwarded to.

### 5.4.5 GPS (UR41 Only)

When you want to receive GPS data, you should enable GPS function on this page.

Enable

#### 5.4.5.1 GPS IP Forwarding

GPS IP forwarding means that GPS data can be forwarded over the Internet.

### GPS IP Forwarding

Enable

Type

Protocol

Keepalive Interval  s

Keepalive Retry  times

Reconnect Interval  s

Report Interval  s

Include RMC

Include GSA

Include GGA

Include GSV

Message Prefix

Message Suffix

Destination IP Address

Server Address	Server Port	Status	Operation
+			

GPS IP Forwarding		
Item	Description	Default
Enable	Forward the GPS data to the client or server.	Disable
Type	Select connection type of the router as Client or Server.	Client
Protocol	Select protocol of data transmission as TCP or UDP.	TCP
Keepalive Interval	After it's connected with server/client, the router will send heartbeat packet regularly to the server/client to keep alive. The interval range is 1-3600s.	75
Keepalive Retry	When TCP heartbeat times out, the router will resend heartbeat. After it reaches the preset retry times, router will reconnect to TCP server. The range is 1-16.	9
Local Port	Set the router listening port. Range: 1-65535.	
Reconnect Interval	After connection failure, router will reconnect to the server at the preset interval. The range is 10-60s.	10
Report Interval	Router will send GPS data to the server/client at the preset interval. The range is 1-60s.	30
Include RMC	RMC includes time, date, position, course and speed data.	--
Include GSA	GSA includes GPS receiver operating mode, satellites used in the position solution, and DOP values.	--
Include GGA	GGA includes time, position and fix type data.	--
Include GSV	GSV includes the number, elevation, azimuth of GPS satellites and SNR values.	--
Message Prefix	Add a prefix to the GPS data.	Null
Message	Add a suffix to the GPS data.	Null

Suffix		
<b>Destination IP Address</b>		
Server Address	Fill in the server address to receive GPS data (IP/domain name).	--
Server Port	Fill in the port to receive GPS data. Range: 1-65535.	--
Status	Show the connection status between the router and the server.	--

### 5.4.5.2 GPS Serial Forwarding

GPS IP forwarding means that GPS data can be forwarded to the serial port.

**GPS Serial Forwarding**

Enable

Serial Type

Trap Interval

Include RMC

Include GSA

Include GGA

Include GSV

[Save](#)

GPS Serial Forwarding		
Item	Description	Default
Enable	Forward the GPS data to the preset serial port.	Disable
Serial Type	Select the serial port to receive GPS data. Ensure that the serial port is enabled on <b>Service &gt; Serial Port</b> .	Serial
Report Interval	Router will forward the GPS data to the serial port at the preset interval. The range is 1-60s.	30
Include RMC	RMC includes time, date, position, course and speed data.	--
Include GSA	GSA includes GPS receiver operating mode, satellites used in the position solution, and DOP values.	--
Include GGA	GGA includes time, position and fix type data.	--
Include GSV	GSV includes the number, elevation, azimuth of GPS satellites and SNR values.	--

### 5.4.5.3 GPS MQTT Forward

GPS MQTT forward means that GPS raw data can be forwarded to MQTT broker automatically.

**GPS MQTT Forwarding**

Enable

Report Interval

Include RMC

Include GSA

Include GGA

Include GSV

**MQTT Forwarding**

MQTT Connections	Topic	Retain	QoS	Operation
<a href="#">+</a>				

GPS MQTT Forward		
Item	Description	Default
Enable	Forward the GPS data to MTT broker automatically.	Disable
Trap Interval	The interval to locate and forward the GPS data to the MQTT broker. The range is 1-60 s.	30
Include RMC	RMC includes time, date, position, course and speed data.	--
Include GSA	GSA includes GPS receiver operating mode, satellites used in the position solution, and DOP values.	--
Include GGA	GGA includes time, position and fix type data.	--
Include GSV	GSV includes the number, elevation, azimuth of GPS satellites and SNR values.	--
MQTT Forward		
MQTT Connections	Select the MQTT connection to send GPS data, it's set up on <b>Service &gt; MQTT</b> page.	
Topic	Topic name for publishing GPS raw data.	
Retain	Enable to set the latest message of this topic as retain message.	
QoS	QoS0, QoS1 or QoS2 are optional.	

### 5.4.6 MQTT

The router supports to work as MQTT client to forward data and router information to MQTT broker in two ways:

1. Users send requests to the router to enquire the router information;
2. The router publishes the data automatically.

MQTT

Connections

ID	Name	Address	Status	Operation
1	mqtttest1	192.168.44.54:1883	Connected	 
2	555	666:1883	Disconnected	 
				

MQTT

**Status**

Status  Disable

**General**

Name

Enable

Broker Address

Broker Port

Client ID

Connection Timeout(s)

Keep Alive Interval(s)

Auto Reconnect

Reconnect Period

Clean Session

**User Credentials**

Enable

Username

Password

**TLS**

Enable

**Last Will and Testament**

Enable

Last-Will Topic

Last-Will QoS

Last-Will Retain

Last-Will Payload

Data Type	Topic	Retain	QoS
Request	<input type="text"/>	<input type="checkbox"/>	<input type="text" value="QoS 0"/>
Response	<input type="text"/>	<input type="checkbox"/>	<input type="text" value="QoS 0"/>

**System Status Publish Topic**

Data Type	Topic	Publish Interval(s)	Retain	QoS
System Info	<input type="text"/>	<input type="text"/>	<input type="checkbox"/>	<input type="text" value="QoS 0"/>
System Status	<input type="text"/>	<input type="text"/>	<input type="checkbox"/>	<input type="text" value="QoS 0"/>
Cellular	<input type="text"/>	<input type="text"/>	<input type="checkbox"/>	<input type="text" value="QoS 0"/>
Ethernet	<input type="text"/>	<input type="text"/>	<input type="checkbox"/>	<input type="text" value="QoS 0"/>
GPS	<input type="text"/>	<input type="text"/>	<input type="checkbox"/>	<input type="text" value="QoS 0"/>

**MQTT Settings**

Item	Description
------	-------------

Status	Show connection status between router and MQTT broker.
--------	--

**General**

Name	Customize a unique connection name. It is not allowed to change after save.
Enable	Enable or disable this MQTT connection.
Broker Address	MQTT broker address to receive data.
Broker Port	MQTT broker port to receive data.
Client ID	Client ID is the unique identity of the client to the server. It must be unique when all clients are connected to the same server, and it is the key to handle messages at QoS 1 and 2.
Connection Timeout/s	If the client does not get a response after the connection timeout, the connection will be considered as broken. The Range: 1-65535.
Keep Alive Interval/s	After the client is connected to the server, the client will send heartbeat packet to the server regularly to keep alive. Range: 1-65535.
Auto Reconnect	When connection is broken, try to reconnect the server automatically.
Reconnect Period	When connection is broken, the period to reconnect the server periodically.

Clean Session	When enabled, the connection will create a temporary session and all information will lose when the client is disconnected from broker; when disabled, the connection will create a persistent session that will remain and save offline messages until the session logs out overtime.
<b>User Credentials</b>	
Enable	Enable user credentials.
Username	The username used for connecting to the MQTT broker.
Password	The password used for connecting to the MQTT broker.
<b>TLS</b>	
Enable	Enable the TLS encryption in MQTT communication.
Mode	Select from Self signed certificates, CA signed server certificate. <b>CA signed server certificate:</b> verify with the certificate issued by Certificate Authority (CA) that pre-loaded on the device. <b>Self signed certificates:</b> upload the custom CA certificates, client certificates and secret key for verification.
<b>Last Will and Testament</b>	
Enable	Last will message is automatically sent when the MQTT client is abnormally disconnected. It is usually used to send device status information or inform other devices or proxy servers of the device's offline status.
Last-Will Topic	Customize the topic to receive last will messages.
Last-Will QoS	QoS0, QoS1 or QoS2 are optional.
Last-Will Retain	Enable to set last will message as retain message.
Last-Will Payload	Customize the last will message contents.
<b>Request and Response Topic</b>	
Topic	The router supports to send requests to enquire router information. <b>Status Request:</b> users is able to send requests to this topic to enquire router information. Request format: <pre>{   "id": "1",   "status": "systeminfo",   "sn": "64E1213132456",   "need_response": 1 //1 means need response }</pre> The id is a random value, and the status can be set as 5 types: systeminfo, systemstatus, cellular, ethernet, gps. <b>Status Response:</b> users is able to subscribe this topic to get the replies.
Retain	Enable to set the latest message of this topic as retain message.
QoS	QoS0, QoS1 or QoS2 are optional.
<b>System Status Publish Topic</b>	
Data Type	Data type sent to MQTT broker automatically. Note that the GPS in this page is not raw data but decoded location data.
Topic	Topic name of the data type used for publishing.

Publish Interval (s)	The interval to publish data to MQTT broker automatically.
Retain	Enable to set the latest message of this topic as retain message.
QoS	QoS0, QoS1 or QoS2 are optional.

### 5.4.7 SNMP

SNMP is widely used in network management for network monitoring. SNMP exposes management data with variables form in managed system. The system is organized in a management information base (MIB) which describes the system status and configuration. These variables can be remotely queried by managing applications.

Configuring SNMP in networking, NMS, and a management program of SNMP should be set up at the Manager.

Configuration steps are listed as below for achieving query from NMS:

1. Enable SNMP setting.
2. Download MIB file and load it into NMS.
3. Configure MIB View.
4. Configure VCAM.

### Related Configuration Example

[SNMP Application Example](#)

#### 5.4.7.1 SNMP

The router supports SNMPv1, SNMPv2c and SNMPv3 version. SNMPv1 and SNMPv2c employ community name authentication. SNMPv3 employs authentication encryption by username and password.

The screenshot shows a configuration page for SNMP. At the top, there are five tabs: 'SNMP', 'MIB View', 'VACM', 'Trap', and 'MIB'. The 'SNMP' tab is selected and underlined. Below the tabs, the heading 'SNMP Settings' is followed by several configuration options:

- Enable:** A checkbox that is currently unchecked.
- Port:** A text input field containing the value '161'.
- SNMP Version:** A dropdown menu currently set to 'SNMPv2'.
- Location Information:** An empty text input field.
- Contact Information:** An empty text input field.

At the bottom left of the configuration area, there is a blue button labeled 'Save'.

SNMP Settings	
Item	Description
Enable	Enable or disable SNMP function.
Port	Set SNMP listened port. Range: 1-65535. The default port is 161.
SNMP Version	Select SNMP version; support SNMP v1/v2c/v3.
Location Information	Fill in the location information.
Contact Information	Fill in the contact information.

### 5.4.7.2 MIB View

This section explains how to configure MIB view for the objects.

SNMP MIB View VACM Trap MIB

| View List

View Name	View Filter	View OID	Operation
<input type="text" value="All"/>	<input type="text" value="Included"/>	<input type="text" value="1"/>	<input type="button" value="✕"/>
<input type="text" value="system"/>	<input type="text" value="Included"/>	<input type="text" value="1.3.6.1.2.1.1"/>	<input type="button" value="✕"/>
			<input type="button" value="⊕"/>

MIB View	
Item	Description
View Name	Set MIB view's name.
View Filter	Select from "Included" and "Excluded".
View OID	Enter the OID number.
Included	You can query all nodes within the specified MIB node.
Excluded	You can query all nodes except for the specified MIB node.

### 5.4.7.3 VACM

This section describes how to configure VACM parameters.

SNMP MIB View VACM Trap MIB

| SNMP v1 & v2 User List

Community	Permission	MIB View	Network	Operation
<input type="text" value="private"/>	<input type="text" value="Read-Write"/>	<input type="text" value="All"/>	<input type="text" value="0.0.0.0/0"/>	<input type="button" value="✕"/>
<input type="text" value="public"/>	<input type="text" value="Read-Only"/>	<input type="text" value="none"/>	<input type="text" value="0.0.0.0/0"/>	<input type="button" value="✕"/>
				<input type="button" value="⊕"/>

VACM	
Item	Description
<b>SNMP v1 &amp; v2 User List</b>	
Community	Set the community name.
Permission	Select from "Read-Only" and "Read-Write".

MIB View	Select an MIB view to set permissions from the MIB view list.
Network	The IP address and bits of the external network accessing the MIB view.
Read-Write	The permission of the specified MIB node is read and write.
Read-Only	The permission of the specified MIB node is read only.
<b>SNMP v3 User Group</b>	
Group Name	Set the name of SNMPv3 group.
Security Level	Select from "NoAuth/NoPriv", "Auth/NoPriv", and "Auth/Priv".
Read-Only View	Select an MIB view to set permission as "Read-only" from the MIB view list.
Read-Write View	Select an MIB view to set permission as "Read-write" from the MIB view list.
Inform View	Select an MIB view to set permission as "Inform" from the MIB view list.
<b>SNMP v3 User List</b>	
Username	Set the name of SNMPv3 user.
Group Name	Select a user group to be configured from the user group.
Authentication	Select from "MD5", "SHA", and "None".
Authentication Password	The password should be filled in if authentication is "MD5" and "SHA".
Encryption	Select from "AES", "DES", and "None".
Encryption Password	The password should be filled in if encryption is "AES" and "DES".

#### 5.4.7.4 Trap

This section explains how to enable network monitoring by SNMP trap.

**SNMP Trap**

Enable

SNMP Version

Server Address

Port

Name

<b>SNMP Trap</b>	
<b>Item</b>	<b>Description</b>
Enable	Enable or disable SNMP Trap function.
SNMP Version	Select SNMP version; support SNMP v1/v2c/v3.
Server Address	Fill in NMS's IP address or domain name.
Port	Fill in UDP port. Port range is 1-65535. The default port is 162.
Name	Fill in the group name when using SNMP v1/v2c; fill in the username when using SNMP v3.
Auth/Priv Mode	Select from "NoAuth & No Priv", "Auth & NoPriv", and "Auth & Priv".

### 5.4.7.5 MIB

This section describes how to download MIB files. The last MIB file “LTE-ROUTER-MIB.txt” is for the router.

MIB	
Item	Description
MIB File	Select the MIB file you need.
Download	Click "Download" button to download the MIB file to PC.

### 5.4.8 TR069

Technical Report 069 (TR-069) is a technical specification of Broadband Forum that defines an application layer protocol for remote management and provisioning of customer-premises equipment (CPE) connected to an Internet Protocol (IP) network.

TR-069	
Item	Description
Enable	Enable or disable TR069 feature.
Last Inform	The last time the router informed to TR069 ACS.
ACS Setting	
URL	The URL of TR069 auto configuration server (ACS).
ACS Username	The username used by ACS to authenticate the CPE when it initiates a connection request.
ACS Password	The password used by ACS to authenticate the CPE when it initiates a connection request.
CPE Setting	
Enable Period Inform	Enable or disable inform periodically.
Period Inform Interval (s)	The interval to report information to ACS, this should be less than the timeout of peer ACS.
CPE Username	The username used by CPE to authenticate the ACS when it initiates a connection request.
CPE Password	The password used by CPE to authenticate the ACS when it initiates a connection request.

## 5.4.9 DLMS

UR41(L) supports periodically enquiring data from meters and uploading it to the platform.

### 5.4.9.1 Physical Device Settings

This section describes how to configure the defined data frame format and interactive command mode on the router to achieve mutual authentication with the meter, mode selection, and data read and write request reply.

Name	Enable	Status	Last Connection Time	Operation
device1	<input checked="" type="checkbox"/>	Connected	2025-09-04 03:30:39	Test Connection Edit Delete

Physical Device List	
Item	Description
Add Device	Add a new physical device. The number of physical device is limited to 30.
Name	The name of the physical device.
Enable	Enable/disable the physical device.
Status	Displays the connection status of the physical device.
Last Connection Time	Displays the last connection time of the physical device.

Operation	<p><b>Test Connection:</b> Tests whether the physical device can be accessed normally. The test result will be returned after completion.</p> <p><b>Edit:</b> Edit the parameters of an added physical device.</p> <p><b>Delete:</b> Delete the added physical device. Devices in use cannot be deleted.</p>
-----------	--

**Add Device**

Enable

Serial

Device Name

Server Address

Logical Server Address

Client Address

Access security

Transport Security

Add Device		
Item	Description	Default
Enable	Enable/disable the physical device.	Enable
Serial	Select the serial port where the physical device is connected.	--
Device Name	The name of the physical device. This name is used in the COSEM group settings to reference the added physical device.	--
Server Address	Enter the server address of the physical device. This information is usually provided in the physical device's user manual.	--
Logical Server Address	Enter the logical server address of the physical device. This information is usually provided in the physical device's user manual. The server address and logical server address of different physical devices cannot both be identical.	1
Client Address	According to standard definitions, the client address is related to user permissions. Each client address represents a different access security level. This information is usually provided in the physical device's user manual.	16
Access security	Authentication allows the physical device (Server) to permit this device (Client) to access data with different permission levels. If set to None, no authentication will be	None

	performed, and only read access will be allowed.	
Password	Set the password for this device (Client) to access the physical device (Server).	--
Transport security	Configure the transmission encryption method for this device (Client) when accessing the physical device (Server).	None
Invocation Counter OBIS Code	Used in specific connection security modes. It specifies the OBIS Code of the device's Invocation Counter. Each time encrypted communication is initiated, the device increments the Invocation Counter by one for comparison and security verification.	--
Authentication Key	Used in specific authentication and connection security modes. Set the authentication key of the physical device, usually provided in the physical device's user manual.	--
Block Cipher Key	Used in specific authentication and connection security modes. Set the block cipher key of the physical device, usually provided in the physical device's user manual.	--
Dedicated Key	A 16-octet value sent by the client to the server during connection establishment. The dedicated key may be regenerated randomly before each connection. Some physical devices expect the dedicated key to be a fixed value.	--

#### 5.4.9.2 COSEM Group Settings

COSEM groups are a convenient way to organize the OBIS codes that you want to send to the remote data collection server. You can add OBIS from different physical devices to the same COSEM group.

Name	Enable	Operation
test	<input checked="" type="checkbox"/>	Test Edit Delete

COSEM Group List	
Item	Description
Add Group	Add a new COSEM group. The number of COSEM groups is up to 10 and the COSEM objects is up to 30 in each group.
Name	The name of the COSEM group.
Enable	Enable/disable the COSEM group.
Operation	<p><b>Test:</b> Test whether the COSEM group can successfully collect data. The test result will be returned after completion.</p> <p><b>Edit:</b> Edit the parameters of the COSEM group.</p> <p><b>Delete:</b> Delete the added COSEM group. COSEM groups in use cannot be deleted.</p>

**Edit**

Enable

Name

Interval  s

COSEM Value

COSEM Value Name	OBIS Code/Short Name	Enable	Operation
------------------	----------------------	--------	-----------

Edit		
Item	Description	Default
Enable	Enable/disable the COSEM group.	/
Name	The name of the COSEM group. This name is used in places such as platform connections to select the COSEM group for reporting.	/
Interval	Read data from the COSEM group at the specified time interval. If the COSEM group is selected in a platform connection, the data will be reported immediately after reading.	60
COSEM Value	Add a new COSEM Value to the COSEM group.	

**Single Add**

Enable

COSEM Value Name

Physical Device

OBIS Code/Short Name

COSEM Class ID

Item	Description
COSEM Value Name	Set the name of the COSEM Value.
Physical Device	Select the physical device(s) associated with the COSEM Value. Multiple selections are allowed.
OBIS Code	The OBIS Code value of the COSEM Value.
COSEM Class ID	The Class ID to which the COSEM Value belongs.
Scan	Scan the selected physical devices for OBIS objects they have in common. Click Apply to fill the parameters of the OBIS object into the corresponding configuration fields above.

### 5.4.9.3 Platform Connection Settings

The router supports data reporting via MQTT or HTTP and data caching.

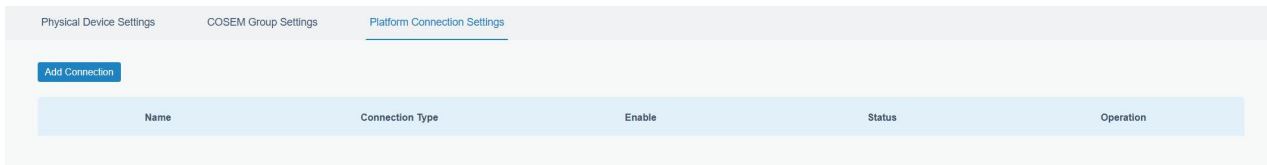

Platform Connection Settings	
Item	Description
Add Connection	Add a new platform connection. The number of connection platforms is up to 3.
Name	Set the name of the platform connection.
Connection Type	Set the connection type to MQTT or HTTP.
Enable	Enable/disable the platform connection.
Status	Show the status of platform connection.
Operation	You can edit the platform configuration or delete the platform.

**Add Connection**

**Server Settings**

Enable

Name

Connection Type

**Data Settings**

Format Type

Data Filtering

Invert

Send as object

Values

Add Connection		
Item	Description	
<b>Server Settings</b>		
Enable	Enable/disable the platform connection.	Enable
Name	Set the name of the platform connection.	/
Connection Type	Set the connection type to MQTT or HTTP.	/
Server Address	The HTTP server address to which the data will be sent.	/
HTTP Header	Headers are name/value pairs that appear in both request and response messages. HTTP headers provide the web server with information about the type of browser making	/

	the request. The format must be [Key: Value], e.g., [Content-Type:application/json]. Up to 30 pairs can be added.	
Retry	Whether to attempt resending when sending fails.	Disable
Retry Count	The number of resend attempts.	3
Retry Interval	The time interval between each resend attempt.	10
MQTT Connection	Select an MQTT connection that has already been added in <b>Service &gt; MQTT</b> .	/
Topic	The MQTT topic for subscription or publication.	/
Retain	Enable/disable the MQTT retained message flag. When enabled, a published message will be stored on the broker so that any client subscribing to the topic later can receive the message.	Disable
QoS	<b>QoS 0:</b> At most once delivery. <b>QoS 1:</b> At least once delivery, until a PUBACK is received from the service; may result in multiple retransmissions. <b>QoS 2:</b> Exactly once delivery; ensures each message is received only once, the safest but slowest service level.	Qos0
<b>Data Settings</b>		
Format Type	Select the message format type used for sending data. <b>JSON:</b> Standard JSON format. <b>Custom:</b> Custom format, supports custom variables.	JSON
Data Filter	Specify which COSEM group(s) to include in the transmitted COSEM data. <b>All:</b> All COSEM groups. <b>Custom:</b> Custom selection of COSEM groups.	All
COSEM Group	Select the COSEM group whose data will be sent to the server.	/
Invert	Reverse filtering. When selected, the system will send data from all COSEM groups except those selected above.	Disable
Cache Segmented Sending	Specify whether multiple cached data segments that failed to send should be sent separately.	Enable
Values	Select which data to include in the reported JSON.	/
Format String	Customize the reported content. Supports variables and text.	/

## 5.5 Maintenance

This section describes system maintenance tools and management.

### 5.5.1 Tools

Troubleshooting tools includes ping, traceroute, packet analyzer and qxdmlog.

#### 5.5.1.1 Ping

Ping tool is engineered to ping outer network.

PING	
Item	Description
Host	Ping outer network from the router.

### 5.5.1.2 Traceroute

Traceroute tool is used for troubleshooting network routing failures.

Traceroute	
Item	Description
Host	Address of the destination host to be detected.

### 5.5.1.3 Packet Analyzer

Packet Analyzer is used for capturing the packet of different interfaces.

Packet Analyzer	
Item	Description
Ethernet Interface	Select the interface to capture packages.
IP Address	Set the IP address that the router will capture.
Port	Set the port that the router will capture.
Advanced	Set the rules for sniffer. The format is tcpdump.

### 5.5.1.4 Qxdmlog

This section allow collecting diagnostic logs via QXDM tool.

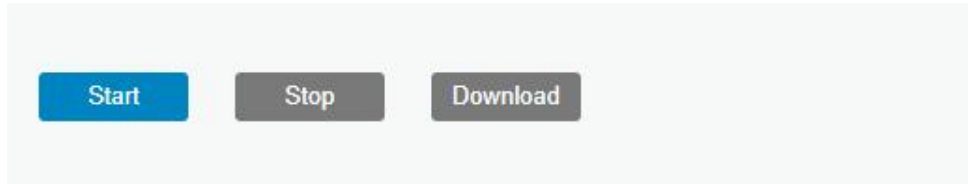

## 5.5.2 Debugger

### 5.5.2.1 Cellular Debugger

This section explains how to send AT commands to router and check cellular debug information.

Cellular Debugger
Firewall Debugger

**Cellular Debugger**

Command  Send

View Recent Logs (lines)  ▼

Result

```

2023-01-16 19:04:34: [SEQ4,ID8]<<< OK
2023-01-16 19:04:36: [SEQ33,ID81]>>> AT+QCFG="risignaltype","physical"
2023-01-16 19:04:36: [SEQ33,ID81]<<< OK
2023-01-16 19:04:37: [SEQ34,ID82]>>> AT+QCFG="urc/ri/other","off"
2023-01-16 19:04:37: [SEQ34,ID82]<<< OK
2023-01-16 19:04:40: [SEQ38,ID63]>>> AT+QMBNCFG="Autosel",1
2023-01-16 19:04:40: [SEQ38,ID63]<<< OK
2023-01-16 19:04:40: [SEQ39,ID13]>>> AT+CPIN?
2023-01-16 19:04:40: [SEQ39,ID13]<<< +CME ERROR: SIM not inserted
2023-01-16 19:04:46: [SEQ1,ID48]>>> AT+CFUN=0
2023-01-16 19:04:47: [SEQ1,ID48]<<< OK
2023-01-16 19:04:52: [SEQ2,ID47]>>> AT+CFUN=1
2023-01-16 19:04:55: [SEQ2,ID47]<<< OK
2023-01-16 19:04:55: [SEQ2,ID47]<<< +CPIN: NOT INSERTED
2023-01-16 19:04:58: [SEQ42,ID13]>>> AT+CPIN?
2023-01-16 19:04:58: [SEQ42,ID13]<<< +CME ERROR: SIM not inserted
2023-01-16 19:05:04: [SEQ1,ID48]>>> AT+CFUN=0
2023-01-16 19:05:04: [SEQ1,ID48]<<< OK

```

Clear Log
Download

#### Cellular Debugger

Item	Description
Command	Enter the AT command that you want to send to cellular modem.
View Recent Logs (lines)	View the specified lines of the result.
Result	Show the response result from cellular modem.

### 5.5.2.2 Firewall Debugger

This section explains how to send commands to router and check firewall information.

The screenshot shows a web interface for the Firewall Debugger. It features two tabs at the top: 'Cellular Debugger' and 'Firewall Debugger'. The 'Firewall Debugger' tab is active. Below the tabs, there is a section titled 'Firewall Debugger'. This section contains a 'Command' input field with the placeholder text 'Eg: -t nat -nvL INPUT' and a blue 'Send' button. Below the command field is a large empty 'Result' area. At the bottom of the interface, there are two buttons: 'Clear Log' and 'Download'.

Firewall Debugger	
Item	Description
Command	Enter the AT command that you want to send to firewall module.
Result	Show the response result from firewall module.

### 5.5.3 Log

The system log contains a record of informational, error and warning events that indicates how the system processes. By reviewing the data contained in the log, an administrator or user troubleshooting the system can identify the cause of a problem or whether the system processes are loading successfully. Remote log server is feasible, and router will upload all system logs to remote log server such as Syslog Watcher.

#### 5.5.3.1 System Log

This section describes how to view the recent log on web.

System Log    Log Download    Log Settings

**Log**

View recent(lines)

```

Mon Jan 16 19:07:40 2023 user.debug httpd[2922]: ==call yruo_log.get
Mon Jan 16 19:07:40 2023 daemon.debug vtysh_ubus[1794]: ubus_lib.c:428 call command 'end'
Mon Jan 16 19:07:40 2023 user.debug httpd[2922]: finish yruo_log.get
Mon Jan 16 19:07:41 2023 daemon.debug zebra[1460]: sql sqldb.c 2306:update smscache set sending='0'
Mon Jan 16 19:07:42 2023 daemon.info zebra[1460]: libgsm/gsm.c:1342 cellular_start: power control to restart usb
Mon Jan 16 19:07:42 2023 daemon.debug zebra[1460]: power off GSM module.
Mon Jan 16 19:07:42 2023 kern.info kernel: [26778.876800] usb 1-1: USB disconnect, device number 22
Mon Jan 16 19:07:42 2023 kern.info kernel: [26778.877926] option1 ttyUSB0: GSM modem (1-port) converter now disconnected from ttyUSB0
Mon Jan 16 19:07:42 2023 kern.info kernel: [26778.878070] option 1-1:1.0: device disconnected
Mon Jan 16 19:07:42 2023 kern.info kernel: [26778.879172] option1 ttyUSB1: GSM modem (1-port) converter now disconnected from ttyUSB1
Mon Jan 16 19:07:42 2023 kern.info kernel: [26778.879296] option 1-1:1.1: device disconnected
Mon Jan 16 19:07:42 2023 kern.info kernel: [26778.880366] option1 ttyUSB3: GSM modem (1-port) converter now disconnected from ttyUSB3
Mon Jan 16 19:07:42 2023 kern.info kernel: [26778.880481] option 1-1:1.2: device disconnected
Mon Jan 16 19:07:42 2023 kern.info kernel: [26778.881587] option1 ttyUSB4: GSM modem (1-port) converter now disconnected from ttyUSB4
Mon Jan 16 19:07:42 2023 kern.info kernel: [26778.881713] option 1-1:1.3: device disconnected
Mon Jan 16 19:07:42 2023 kern.info kernel: [26778.882443] qmi_wwan 1-1:1.4 cellular0: unregister 'qmi_wwan' usb-ci_hdrc.1-1,

```

[Clear Log](#)

System Log	
Item	Description
View recent (lines)	View the specified lines of system log.
Clear Log	Clear the current system log.

### 5.5.3.2 Log Download

This section describes how to download log files.

System Log    **Log Download**    Log Settings

**Download**

[Download All](#)

File Name	File Size/KB	Creation Time	Operation
vpn.log	2	2023/01/16 11:42:16	<a href="#">↓</a>
system.log	79	2023/01/16 19:08:25	<a href="#">↓</a>
httpd.log	901	2023/01/16 19:08:25	<a href="#">↓</a>
firewall.log	0	2023/01/13 14:54:07	<a href="#">↓</a>
cellular.log	868	2023/01/16 19:08:19	<a href="#">↓</a>

Log Download	
Item	Description
Download All	Download all log files.

File Name	Show the name of log files.
File Size/KB	Show the size of log files.
Creation Time	Show the creation time of log files.
Operation	Click to download every log file.

### 5.5.3.3 Log Settings

This section explains how to enable remote log server and local log setting.

Log Settings	
Item	Description
<b>Remote Log Server</b>	
Enable	With “Remote Log Server” enabled, router will send all system logs to the remote server.
Syslog Server Address	Fill in the remote system log server address (IP/domain name).
Port	Fill in the remote system log server port.
<b>Local Log File</b>	
Storage	User can store the log file in memory.
Size	Set the size of the log file to be stored.
Log Severity	The list of severities follows the syslog protocol.

### 5.5.4 Upgrade

This section describes how to upgrade the router firmware via web. Generally you don't need to do

the firmware upgrade.

**Note:** any operation on web page is not allowed during firmware upgrade, otherwise the upgrade will be interrupted, or even the device will break down.

Upgrade

---

**Upgrade**

Firmware Version 41.0.0.5

Reset Configuration to Factory Default

Upgrade Firmware  
Browse
Upgrade

Upgrade	
Item	Description
Firmware Version	Show the current firmware version.
Reset Configuration to Factory Default	When this option is checked, the router will be reset to factory defaults after upgrade.
Upgrade Firmware	Click "Browse" button to select the new firmware file, and click "Upgrade" to upgrade firmware.

## Related Configuration Example

### [Firmware Upgrade](#)

### 5.5.5 Backup and Restore

This section explains how to create a complete backup of the system configurations to a file, restore the config file to the router and reset to factory defaults.

**Restore Config**

Config File  
Browse
Import

**Backup Running-config**

Full Backup
Partial Backup

**Restore Factory Defaults**

Reset

Backup and Restore	
Item	Description
Config File	Click "Browse" button to select configuration file, and then click

	"Import" button to upload the configuration file to the router.
Full Backup	Export the all configurations file to the PC.
Partial Backup	Export all configurations except for the following pages to the PC. Configurations not included in partial backup: <ul style="list-style-type: none"> <li>● Network → Interfaces → WAN: All configurations</li> <li>● Network → Interfaces → WLAN: Configurations when set to AP mode</li> <li>● System → User Management: All configurations</li> <li>● System → Device Management → Device Management: Configurations when DeviceHub is selected and activated via authorization code</li> <li>● System → Device Management → MilesightVPN: All configurations</li> </ul>
Reset	Click "Reset" button to reset factory default settings. Router will restart after reset process is done.

## Related Configuration Example

[Restore Factory Defaults](#)

### 5.5.6 Reboot

On this page you can reboot the router immediately or regularly. We strongly recommend clicking "Save" and "Apply" button before rebooting the router so as to avoid losing the new configuration.

Reboot	
Item	Description
Reboot Now	Reboot the router immediately.
Schedule	
Enable	Reboot the router at a scheduled frequency.

Cycles

Select the date and time to execute the schedule.

## Chapter 6 Application Examples

### 6.1 Cellular Connection

We are about to take an example of inserting a SIM card of the router and configuring the router to get Internet access through cellular.

#### Configuration Steps

1. Ensure the SIM card is inserted well before powering on and all cellular antennas are connected to the correct connectors.
2. Go to **Network > Interface > Cellular > SIM Setting** to configure the SIM info, then click  to configure the cellular interfaces, click **OK** to save configuration.

Interface Name	Status	Network Type	IP	APN	Enable Status	Operation
SIM1-APN1	Connect Successfully	Auto	10.125.133.127/2408.8448.2003.a...	ctnet2	<input checked="" type="checkbox"/>	
SIM1-APN2	Connect Successfully	Auto	10.130.90.197/2408.8448.2000.47...	ctnet	<input checked="" type="checkbox"/>	
SIM1-APN3	-	Auto	-	ctnet4	<input type="checkbox"/>	

3. Enable **Network > Interface > Cellular > Ping Detection** to configure ping detection information.

#### Ping Detection

Enable

IPv4 Primary Server

IPv4 Secondary Server

IPv6 Primary Server

IPv6 Secondary Server

Interval  s

Retry Interval  s

Timeout  s

Max Ping Retries

4. Go to **Status > Cellular** to view the status of the cellular connection. If it shows Connected, SIM card has dialed up successfully.
5. Open your preferred browser on PC, type any available web address into address bar and see if it is able to visit Internet via the router.

#### Related Topic

[Cellular Setting](#)

[Cellular Status](#)

## 6.2 OpenVPN Client Application Example

The routers can work as OpenVPN clients or OpenVPN servers. We are about to take an example of configuring OpenVPN client to connect to OpenVPN cloudConnexa.

### Configuration Steps

1. Ensure the router has gotten access to the Internet.
2. Log in to the cloudConnexa account, select the Network section, select the service depending on your requirement, and follow the wizard to continue the settings.

#### Select Network Scenarios

Please select all applicable scenarios for the network you are going to create.

**Remote Access** ⊙

Connect your private resources to CloudConnexa. Provide remote access to your resources, which are hosted on IaaS Cloud, and on premises resources.

[Read more](#)

**Site-to-site** ⊙

Connect multiple private networks to CloudConnexa (site-to-site connectivity). This wizard will assist you in adding a single network. You can use this wizard to connect all of your networks.

[Read more](#)

**Secure Internet Access** ⊙

Provide secure access to public resources. Use this network as an Internet Gateway for all internet traffic or only for selected public resources. You can then apply whitelisting rules to your public resources.

[Read more](#)

If you would like to connect a single server you can create a [host](#) and connect your server directly to CloudConnexa

[Skip Wizard](#)

[Continue](#)

3. Select the provider type as OpenWrt and download the OVPN file.

#### Deploy Network Connector (connector01)

##### Connector Details

Name

**connector01**

Region

**Singapore**

Each Connector must be installed and connected to CloudConnexa. Select where you would like to deploy Network Connector.

OpenVPN Compatible Router : **OpenWrt** ⌵

#### 1 Download .ovpn Profile

[Download OVPN Profile](#)

#### 2 Use .ovpn Profile

Use .ovpn Profile on your router and connect it to CloudConnexa

[Read how to use .ovpn Profile and connect OpenWrt router to CloudConnexa](#)

4. If you need to access the terminal devices under subnet, it's necessary to add the route and IP service as LAN subnet of the router.

**Network Configuration**  
Selected Scenarios: Remote Access

**Add route**  
Routes define public and private subnets that will be routed to this Network. Routes are pushed to the routing table of User Devices and Connectors, so that they can access IP Services.

No Route defined yet.

[Add Route](#)

**Add IP Service**  
IP Services are defined as access to specific IP address ranges and protocols.

No IP Service defined yet.

[Add IP Service](#)

- ✓ Define Network
- ✓ Deploy Network Connector connector01 ✓
- ✓ Add Application
- 4 Add Routes and IP Services**
- 5 Configure Access Group (Optional)

5. Go to **Network > VPN > OpenVPN Client**, select configuration method as File Configuration, then import the OVPN file.

**OpenVPN Client Settings**

OpenVPN Client\_1

Enable

Configuration Method

Configuration File  [Browse](#) [Import](#) [Export](#) [Delete](#)

6. Go to **Status > VPN** page to check if the client is connected.

Overview Cellular Network WLAN <u>VPN</u> Routing Host List GPS				
Clients				
Name	Status	Local IP	Remote IP	
openvpn_1	Connected	100.96.1.18	100.96.1.17	
ipsec_1	Disconnected	-	-	

You can also check the connection status on CloudConnexa.

**CloudConnexa**

221028  
openvpn.com

Status

Users

**Networks**

Networks

Applications

IP Services

Connectors

**Networks**  
Configure a Network to connect physical and virtual networks, including distributed networks. [Add Network](#)

All Online Offline Online with Issues Filter

Connection Status	Name	Internet Access	Internet Gateway (Egress)	Applications	IP Services
<input type="checkbox"/>	<a href="#">Milesight device</a>	Split Tunnel On	Off		
<input checked="" type="checkbox"/>	test	Split Tunnel On	Off		test

## Related Topic

[OpenVPN Client](#)

[VPN Status](#)

## 6.3 NAT Application Example

### Example

An UR41(L) router can access to the Internet via cellular and get a public IP address. LAN port is connected with an IP camera whose IP address is 192.168.23.165 and HTTP port is 80. This IP camera can be accessed by public IP address via the below port mapping settings.

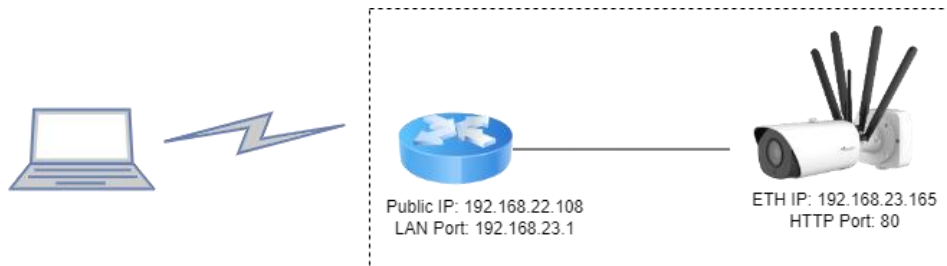

### Configuration Steps

Go to **Firewall > Port Mapping** and configure port mapping parameters as below. Source IP address 0.0.0.0/0 means all external addresses are allowed to access. After that, users can use public IP: external port to access the IP camera.

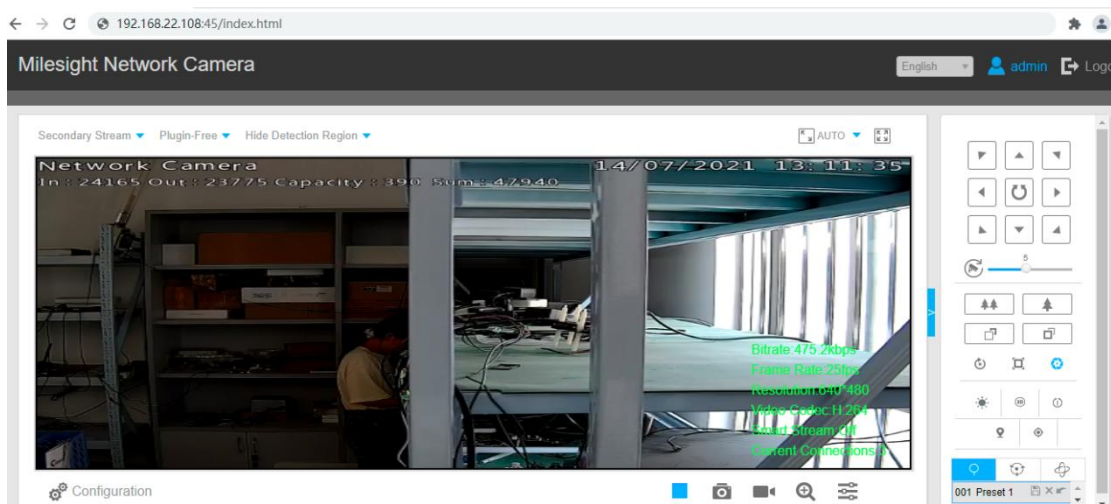
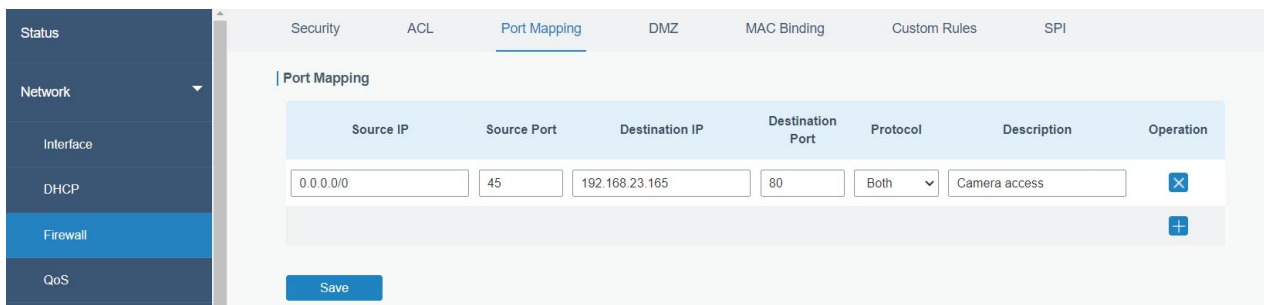

### Related Topic

[Port Mapping](#)

## 6.4 DTU Application Example

### Example

A PLC is connected with the router via RS232. Then enable DTU function of the router to make a remote TCP server communicate with PLC. Refer to the following topological graph.

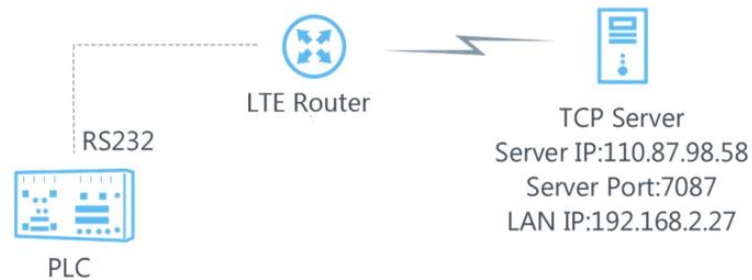

### Configuration Steps

1. Go to **Industrial > Serial Port > Serial** and configure serial port parameters. The serial port parameter shall be kept in consistency with those of PLC, as shown in figure below.

Serial

**Serial Settings**

Enable

Serial Type RS232

Baud Rate 9600

Data Bits 8bits

Stop Bits 1bits

Parity None

Software Flow Control

2. Configure Serial Mode as **DTU Mode**, DTU protocol as Transparent and protocol as TCP.

Serial Mode	DTU Mode	▼
DTU Protocol	Transparent	▼
Protocol	TCP	▼
Keepalive Interval	75	s
Keepalive Retry Times	9	
Packet Size	1024	Bytes
Serial Frame Interval	100	ms
Reconnect Interval	10	s
Specific Protocol	<input type="checkbox"/>	
Register String		

### 3. Configure TCP server IP and port.

Destination IP Address

Server Address	Server Port	Status	Operation
110.87.98.58	7087		✕
			+

Save

### 4. Start TCP server on PC. Take "Netassist" test software as example. Make sure port mapping is already done.

Settings

(1) Protocol  
TCP Server

(2) Local host IP  
192.168.2.27

(3) Local host port  
7087

Disconnect

### 5. Connect the router to PC via RS232 for PLC simulation. Then start **sscom** software on the PC to test communication through serial port.

ComNum COM9

BaudRate 9600

DataBits 8

StopBits 1

Verify None

FlowControl None

DTR

Send event 100

SendHEX

Data input:  
hello

- After connection is established between the router and the TCP server, you can send data between sscocom and Netassist.

### PC side

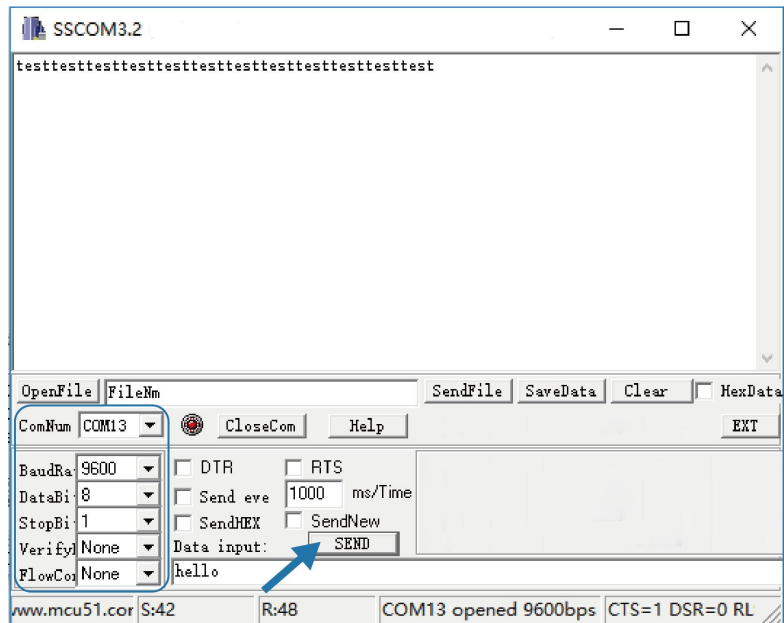

### TCP server side

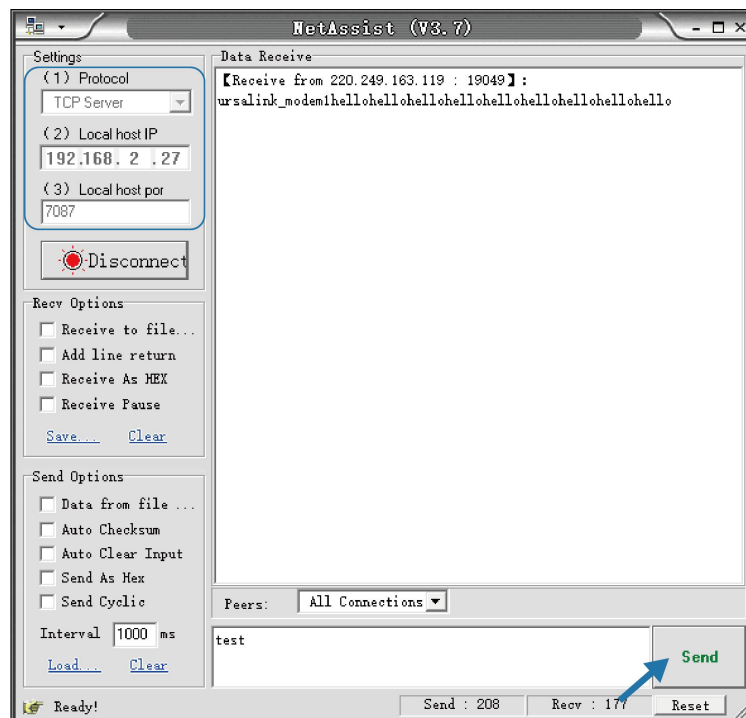

- After serial communication test is done, you can connect PLC to RS232 port of the router for test.

### Related Topic

[Serial Port](#)

## 6.5 Restore Factory Defaults

### Method 1:

Log in web interface, and go to **Maintenance > Backup and Restore**, click **Reset** button.

You will be asked to confirm if you'd like to reset it to factory defaults. Then click **Reset** button.

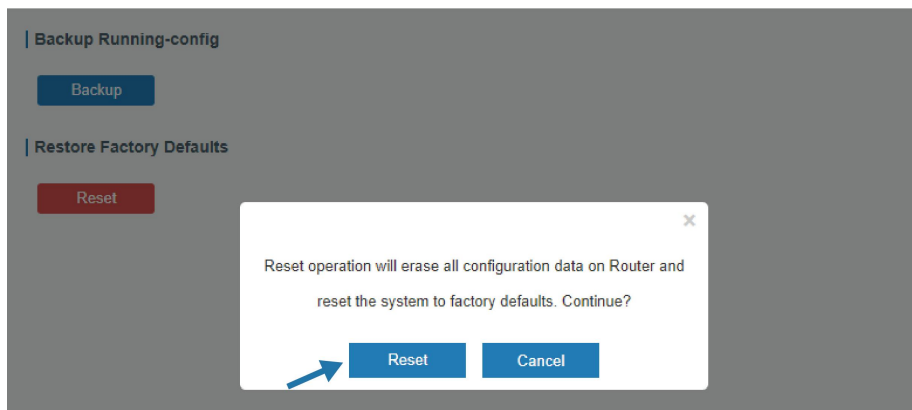
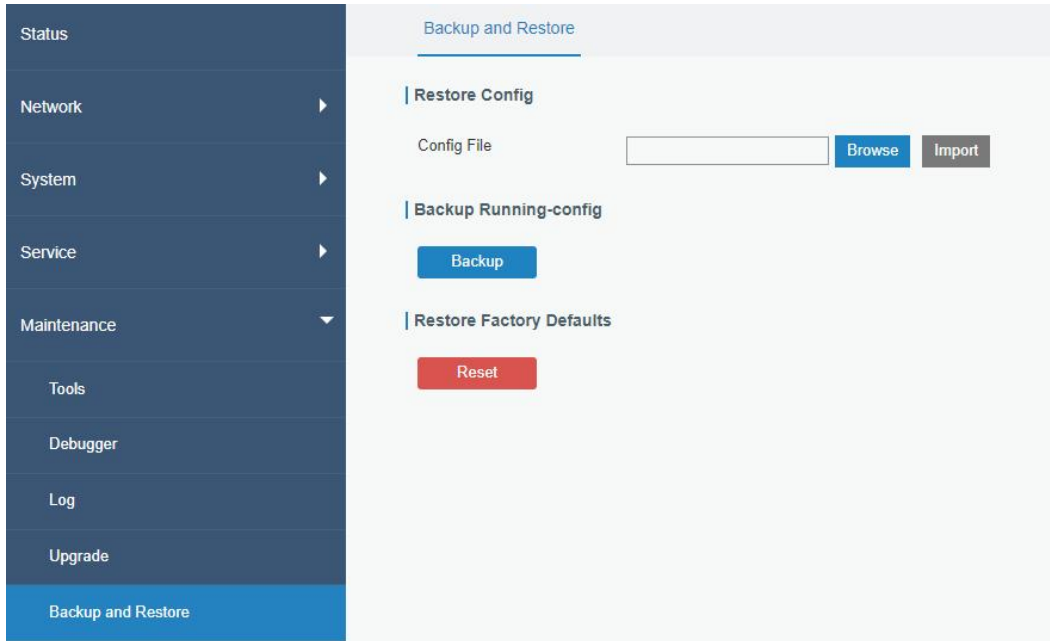

Then the router will reboot and restore to factory settings immediately.

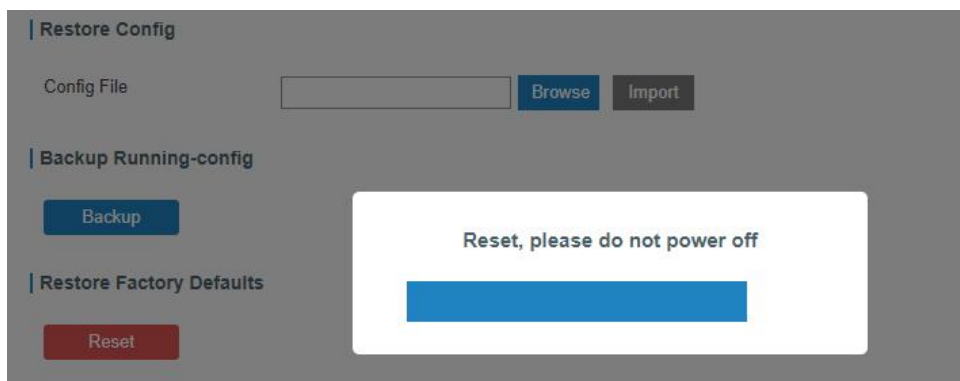

Please wait till the SYSTEM LED blinks slowly and login page pops up again, which means the router has already been reset to factory defaults successfully.

## Related Topic

[Restore Factory Defaults](#)

### Method 2:

Locate the reset button on the router, press and hold the reset button for more than 5 seconds until SYSTEM LED blinks.

## 6.6 Firmware Upgrade

It is suggested that you contact Milesight technical support first before you upgrade router firmware. After getting firmware file please refer to the following steps to complete the upgrade.

1. Go to **Maintenance > Upgrade**, click **Browse** and select the correct firmware file from the PC.
2. Click **Upgrade** and the router will check if the firmware file is correct. If it's correct, the firmware will be imported to the router, and then the router will start to upgrade.

**Note: It is recommended to check the box of Reset Configuration to Factory Default before upgrade.**

The screenshot displays the 'Upgrade' page in the Milesight router's web interface. On the left is a dark blue sidebar menu with options: Status, Network, System, Service, Maintenance, Tools, Debugger, Log, and Upgrade (highlighted in light blue). The main content area is titled 'Upgrade' and shows the 'Router' section. It includes the following fields and controls:

- Firmware Version:** 41.0.0.3-a2
- Reset Configuration to Factory Default:** An unchecked checkbox.
- Upgrade Firmware:** A text input field followed by a blue 'Browse' button and a grey 'Upgrade' button.

## Related Topic

[Upgrade](#)

## 6.7 SNMP Application Example

Before you configure SNMP parameters, please download the relevant **MIB** file from the router's WEB GUI first, and then upload it to any software or tool which supports standard SNMP protocol. Here we take **ManageEngine MibBrowser Free Tool** as an example to access the router to query cellular information.

1. Go to **System > SNMP > MIB** and download the MIB file "LTE-ROUTER-MIB.txt" to PC.

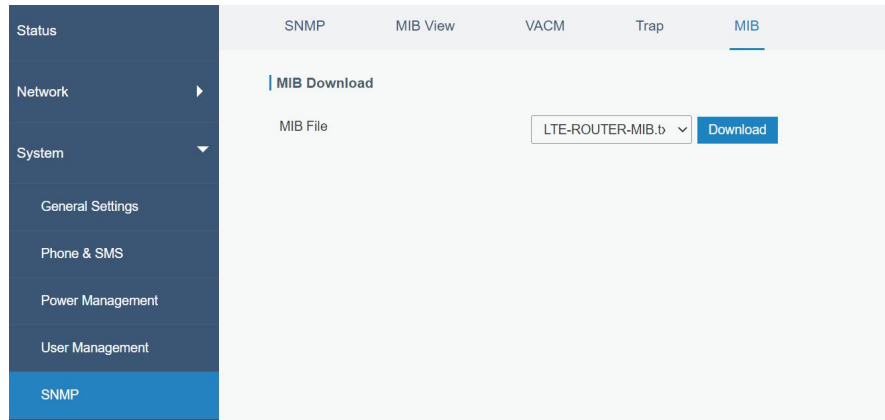

2. Start “ManageEngine MibBrowser Free Tool” on the PC. Click **File > Load MIB** on the menu bar. Then select “LTE-ROUTER-MIB.txt” file from PC and upload it to the software.

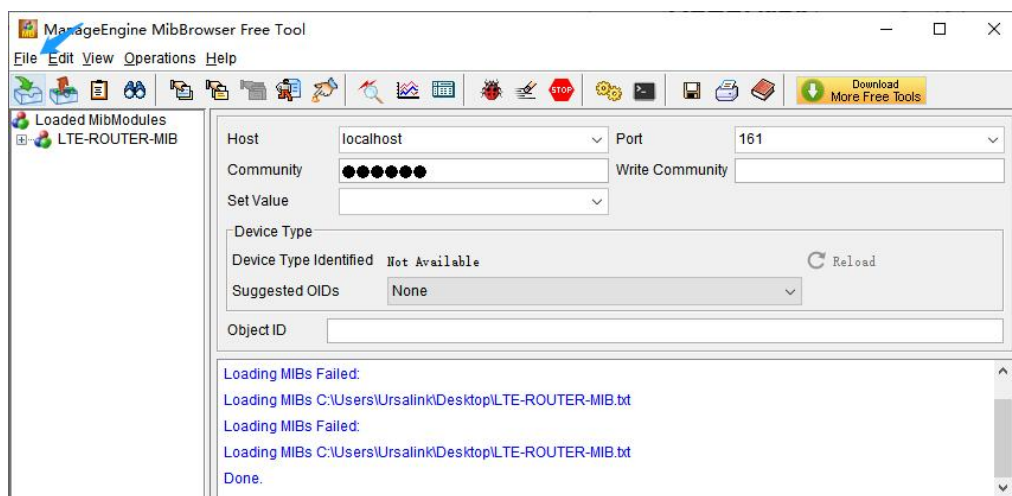

Click the + button beside “LTE-ROUTER-MIB”, which is under the “Loaded MibModules” menu, and find “usCellularinfo”. And then you will see the OID of cellular info is “.1.3.6.1.4.1.50234”, which will be filled in the MIB View settings.

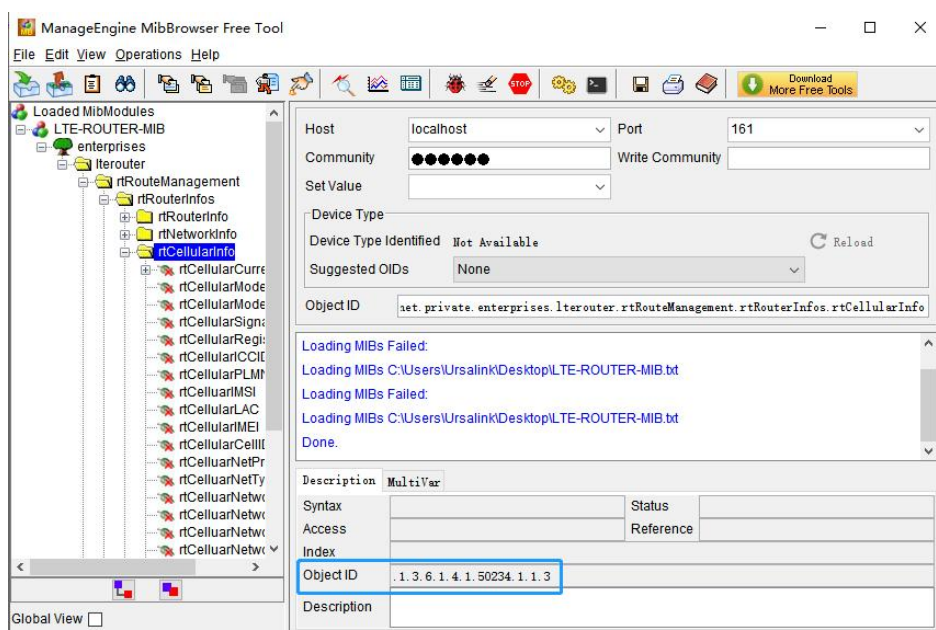

- Go to **System > SNMP > SNMP** on the router's WEB GUI. Check **Enable** option, then click **Save** button.

The screenshot shows the 'SNMP Settings' configuration page. The 'Enable' checkbox is checked. The 'Port' field contains '161'. The 'SNMP Version' dropdown is set to 'SNMPv2'. The 'Location Information' field contains 'Xiamen\_China'. The 'Contact Information' field contains 'Xiamen\_Milesight'. A blue 'Save' button is located at the bottom left of the form.

- Go to **System > SNMP > MIB View**. Click **+** to add a new MIB view and define the view to be accessed from the outside network. Then click **Save** button.

The screenshot shows the 'MIB View' configuration page. A table titled 'View List' contains one entry: 'cellular' with an 'Included' filter and View OID '1.3.6.1.4.1.50234.1.3'. There are 'x' and '+' icons in the 'Operation' column. A blue 'Save' button is at the bottom left.

View Name	View Filter	View OID	Operation
cellular	Included	1.3.6.1.4.1.50234.1.3	x +

- Go to **System > SNMP > VACM**. Click **+** to add a new VACM setting to define the access authority for the specified view from the specified outside network. Click **Save** and **Apply** to make the changes take effect.

The screenshot shows the 'SNMP v1 & v2 User List' configuration page. A table contains one entry: 'public' with 'Read-Write' permission, 'cellular' MIB View, and '0.0.0.0/0' network. There are 'x' and '+' icons in the 'Operation' column. A blue 'Save' button is at the bottom left.

Community	Permission	MIB View	Network	Operation
public	Read-Write	cellular	0.0.0.0/0	x +

- Go to MibBrowser, enter host IP address, port and community. Right click **usCellular CurrentSim**

and then click **FET**. Then you will get the current SIM info on the result box. You can get other cellular info in the same way.

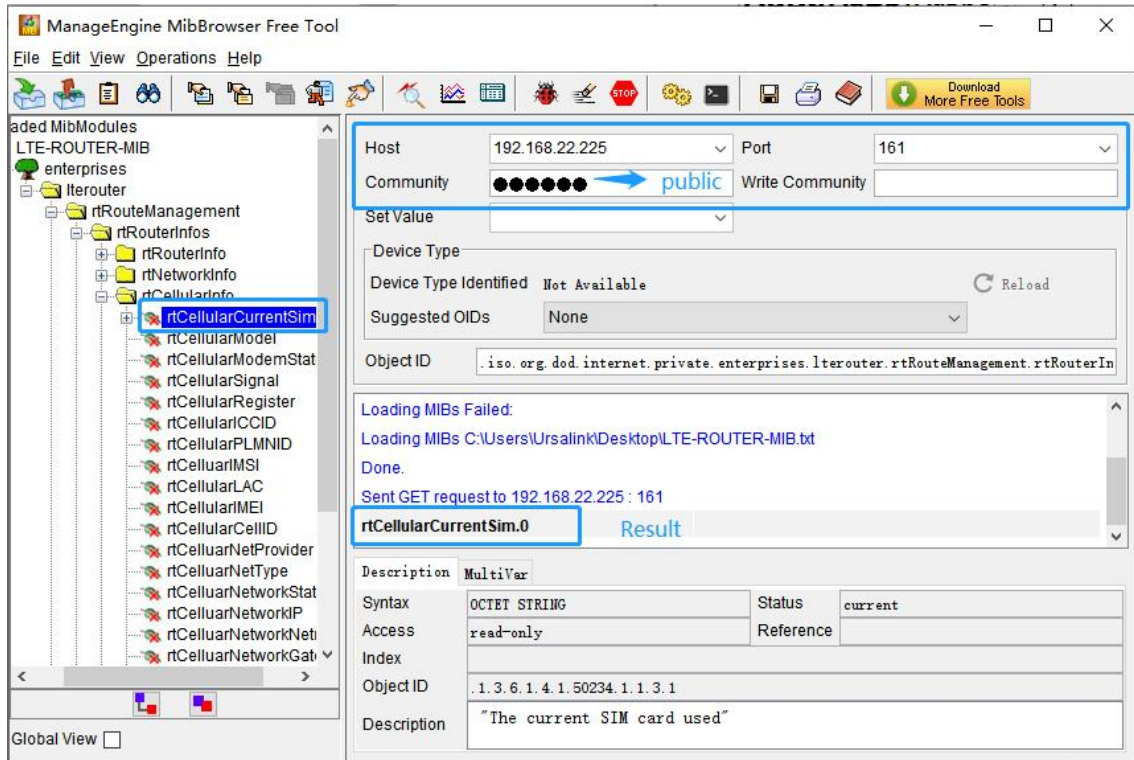

## Related Topic

[SNMP](#)

## 6.8 QoS Application Example

### Example

Configure the router to distribute local preference to different FTP download channels. The total download bandwidth is 75000 kbps.

**Note:** the “Total Download Bandwidth” should be less than the real maximum bandwidth of WAN or cellular interface.

FTP Server IP & Port	Percent	Max Bandwidth(kbps)	Min Bandwidth(kbps)
110.21.24.98:21	40%	30000	25000
110.32.91.44:21	60%	45000	40000

### Configuration Steps

1. Go to **Network > QoS > QoS(Download)** to enable QoS and set the total download bandwidth.

**Download Bandwidth**

Enable

Default Category

Download Bandwidth  kbits/s

Capacity

2. Please find **Service Category** option, and click “+” to set up service classes.

**Note: the percents must add up to 100%.**

**Service Category**

Name	Percent(%)	Max BW(kbps)	Min BW(kbps)	Operation
1	40	30000	25000	<input type="button" value="X"/>
2	60	45000	40000	<input type="button" value="X"/>
				<input type="button" value="+"/>

3. Please find **Service Category Rules** option, and click “+” to set up rules.

**Service Category Rules**

Name	Source IP	Source Port	Destination IP	Destination Port	Protocol	Service Category	Operation
ftp1	110.21.24.98	21			ANY	1	<input type="button" value="X"/>
ftp2	110.32.91.44	21			ANY	2	<input type="button" value="X"/>
							<input type="button" value="+"/>

**Note:**

**IP/Port: null refers to any IP address/port.**

Click “Save” and “Apply” button.

## Related Topic

[QoS Setting](#)

## 6.9 DLMS Client Example

The routers can work as DLMS clients. We are about to take an example of configuring router to read data from meters and upload it to the platform.

### Configuration Steps

1. Connect the meter to the serial port of the router.
2. Go to **Service > Serial Port > Serial**, enable Serial and configure serial port parameters.  
The serial port parameters must be consistent with those of the DLMS meter. Then configure

Serial Mode as DLMS Connection, and click “Navigate to the Services- DLMS page to configure”.

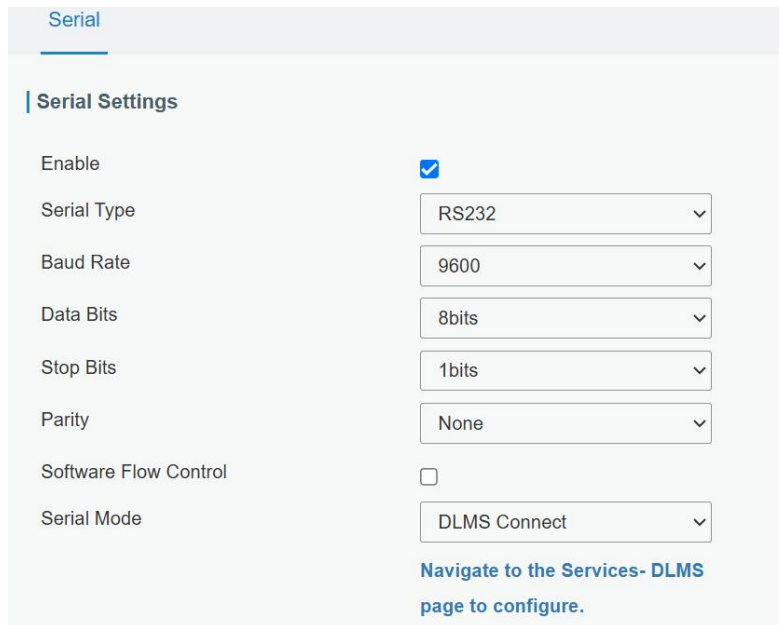

**Serial**

**Serial Settings**

Enable

Serial Type

Baud Rate

Data Bits

Stop Bits

Parity

Software Flow Control

Serial Mode

[Navigate to the Services- DLMS page to configure.](#)

- Jump to **DLMS > Physical Device Settings**, click “Add Device” to create a new DLMS physical device interface and configure device parameters as below.

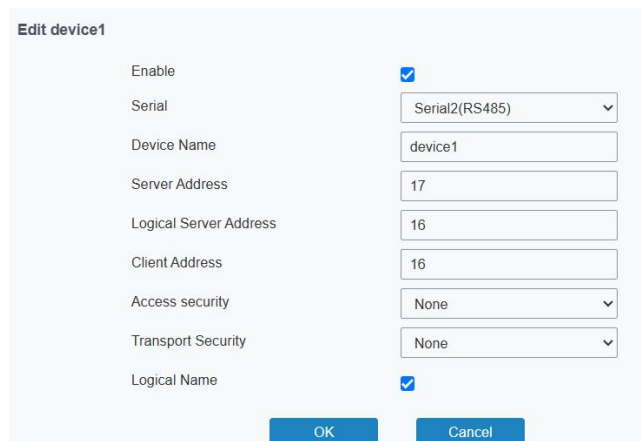

**Edit device1**

Enable

Serial

Device Name

Server Address

Logical Server Address

Client Address

Access security

Transport Security

Logical Name

After configuring the DLMS physical device, press the "Test Connection" button to verify whether the configuration is correct. If the connection fails, an error message will be returned to prompt the user to reconnect or modify the configuration parameters.

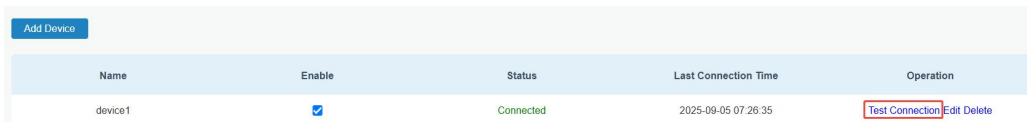

Name	Enable	Status	Last Connection Time	Operation
device1	<input checked="" type="checkbox"/>	Connected	2025-09-05 07:26:35	<input type="button" value="Test Connection"/> <input type="button" value="Edit Delete"/>

- Go to **DLMS > COSEM Group Settings**, click “Add Group” to create a new DLMS group and configure how frequently you want to read the data from the devices.

**Edit**

Enable

Name

Interval  s

COSEM Value

Click "Single Add" button, you can configure the COSEM value name and select the physical value device created earlier. Then click the "Scan" button, the COSEM object of the selected device will be displayed below. When you click the "Reapply" button, the OBIS Code and Class ID will be automatically filled in the above configuration items.

**Single Add**

Enable

COSEM Value Name

Physical Device

OBIS Code

COSEM Class ID

OBIS Code	COSEM Class ID	Apply
0.0.42.0.0.255	Data (ID:1)	Reapply
0.0.43.1.0.255	Data (ID:1)	Reapply
0.0.43.1.1.255	Data (ID:1)	Reapply
0.0.43.1.2.255	Data (ID:1)	Reapply

Once all of the configuration is enabled and saved, we can re-open the COSEM group we have created, and press the TEST button.

Name	Enable	Operation
cosem1	<input checked="" type="checkbox"/>	Test Edit Delete

- Go to **DLMS > Platform Connection Settings**, click "Add Connection" to create a new platform connection and configure the parameters.

**Server Settings**

Enable

Name

Connection Type

Server Address

HTTP Header

Retry

**Data Settings**

Format Type

Data Filter

Invert

Send as object

Values

Check if the platform is connected.

Physical Device Settings   COSEM Group Settings   Platform Connection Settings

[Add Connection](#)

Name	Connection Type	Enable	Status	Operation
mqtt	MQTT	<input checked="" type="checkbox"/>	Connected	<a href="#">Edit</a> <a href="#">Delete</a>
http	HTTP	<input checked="" type="checkbox"/>	Disconnected	<a href="#">Edit</a> <a href="#">Delete</a>

## Related Topic

[Serial Port](#)

**[END]**