



VS135

Ultra ToF People Counter

User Guide

# Contents

<b>Chapter 1. Preface.....</b>	<b>5</b>
Copyright Statement.....	5
Safety Instruction.....	5
Revision History.....	6
<b>Chapter 2. Product Introduction.....</b>	<b>8</b>
Overview.....	8
Key Features.....	8
<b>Chapter 3. Hardware Introduction.....</b>	<b>9</b>
Packing List.....	9
Hardware Overview.....	10
Dimensions (mm).....	10
Button and LED Indicators.....	10
<b>Chapter 4. Power Supply.....</b>	<b>11</b>
<b>Chapter 5. Installation.....</b>	<b>12</b>
Preparation before Installation.....	12
Covered Detection Area.....	12
Installation Position.....	15
Environment Requirements.....	16
Installation Step.....	16
Factors Affecting Accuracy.....	18
<b>Chapter 6. Access the Sensor.....</b>	<b>19</b>
<b>Chapter 7. Operation Guide.....</b>	<b>22</b>
Basic Counting Settings.....	22
Deployment Parameters.....	22
Device Strategies.....	23
Line Crossing Counting.....	25
Region People Counting.....	29

Advance Property Settings.....	33
Children Distinction .....	33
Staff Detection.....	35
Group Counting.....	36
U-turn Filtering.....	38
Occlusion Settings.....	42
Obstacle Exclusion.....	43
Heat Map.....	44
Multi-Device Stitching.....	45
Overview.....	45
Multi-Stitching Compatible List.....	47
Node Device Setting.....	49
Master Device Setting.....	50
Data Presentation.....	54
Dashboard.....	55
Report.....	56
Communication.....	58
WLAN.....	58
LoRa.....	59
Validation.....	63
System.....	66
Device Info.....	66
User.....	66
Time Configuration.....	68
System Maintenance.....	70
<b>Chapter 8. Communication Protocol.....</b>	<b>73</b>
Overview.....	73
Uplink Data.....	73
Basic Information.....	73

## Contents

Periodic Report.....	74
Trigger Report.....	80
Alarm Report.....	82
Historical Data.....	83
Downlink Command.....	84
General Setting.....	84
Report Setting.....	86
Data Retransmission.....	86
LoRaWAN <sup>®</sup> Setting.....	87
Historical Data Enquiry.....	88
<b>Chapter 9. Services.....</b>	<b>90</b>

# Chapter 1. Preface

## Copyright Statement

This guide may not be reproduced in any form or by any means to create any derivative such as translation, transformation, or adaptation without the prior written permission of Xiamen Milesight IoT Co., Ltd (Hereinafter referred to as Milesight).

*Milesight* reserves the right to change this guide and the specifications without prior notice. The latest specifications and user documentation for all Milesight products are available on our official website <http://www.milesight.com>

## Safety Instruction

Milesight will not shoulder responsibility for any loss or damage resulting from not following the instructions of this operating guide.



### Warning:

Serious injury or death may be caused if any of these warnings is neglected.

- This installation must be conducted by a qualified service person and should strictly comply with the electrical safety regulations of the local region.
- To avoid risk of fire and electric shock, do keep the product away from rain and moisture before installation.
- Do not touch components which may be hot.
- Make sure the plug is firmly inserted into the power socket.
- Make sure the device is firmly fixed when installing.
- The device must not be disassembled or remodeled in any way.



### CAUTION:

Injury or equipment damage may be caused if any of these cautions are neglected.

- Do not place the device where the temperature is below/above the operating range.
- The device must never be subjected to shocks or impacts.
- Do not expose the device to where a laser beam equipment is used.
- To prevent heat accumulation, do not block air circulation around the device.



- Use a soft, dry cloth to clean the lens of the device. Stubborn stains can be removed using a cloth dampened with a small quantity of detergent solution, then wipe them dry.
- Do not use volatile solvents such as alcohol, benzene or thinners as they may damage the surface finishes.

## Revision History

Data	Doc Version	Description
Feb. 23, 2024	V1.0	Initial version
May 20, 2024	V1.1	<ol style="list-style-type: none"> <li>1. Support to configure WLAN IP address;</li> <li>2. Add ToF lighting mode and noise filtering;</li> <li>3. Add validation record task list;</li> <li>4. Add Enhanced Detection Mode;</li> <li>5. Update installation distance.</li> </ol>
Jul.30, 2024	V1.2	<ol style="list-style-type: none"> <li>1. Add Multi-Device Stitching;</li> <li>2. Add detection line list;</li> <li>3. Add People Counting Trigger Report.</li> </ol>
Feb. 12, 2025	V1.3	<ol style="list-style-type: none"> <li>1. Add configuration of Wi-Fi passwords at login, user passwords are required to contain 4 styles.</li> <li>2. Add Obstacle Exclusion.</li> <li>3. Add Occlusion Detection.</li> <li>4. Add Heatmap.</li> <li>5. Add reporting on the dot.</li> <li>6. Support time synchronization with the LoRaWAN<sup>®</sup> network server.</li> <li>7. Support Individual Filter of Group Counting.</li> <li>8. Add LED indicator switch and diagnostic function for support.</li> </ol>

Data	Doc Version	Description
		<ul style="list-style-type: none"><li>9. Support for downloading logs and Ping detection.</li><li>10. Support separate reporting of children's data.</li></ul>
May 28, 2025	V1.4	<ul style="list-style-type: none"><li>1. Add automatic U-turn filtering.</li><li>2. Add Record Track Start/Stop Points and show Static Track Line.</li><li>3. Add Log Mode - File to choose the level of the download log files.</li><li>4. Add downlink commands.</li><li>5. Support to configure TX Power.</li><li>6. Add Data Retransmission and Retrievability.</li><li>7. Modify the display style of real-time track line and preview layout.</li><li>8. Remove Ping detection.</li></ul>

# Chapter 2. Product Introduction

## Overview

VS135 is a high-end people counting sensor that is based on deep learning AI and second-generation ToF technology. It is capable of adapting to various complex scenarios while ensuring excellent privacy protection. This sensor possesses an impressive accuracy of up to 99.8% in people counting, fully meeting your needs, and it delivers exceptional performance for both indoor and outdoor applications. With high ceiling mounting of up to 6.5m and an IP65 waterproof rating, it adapts seamlessly to any environment.

## Key Features

- Up to 99.8% accuracy with the 2nd generation ToF technology and AI algorithm.
- Allow to collect more accurate people counting data by differentiating children / adults and detecting staffs via identification like staff lanyards for clearer people analysis.
- Smart U-turn detection to filter redundant counting of people wandering in the area.
- Support queuing management via dwell time detection and regional people counting.
- With radar sensor based ESG friendly working mode, it allows to experience full-speed operation when occupied while switching to a power-saving sleep mode when unoccupied.
- By incorporating 3-axis sensors for automatic height calibration, it ensures enhanced precision and guarantees accurate data analysis.
- Support automatic compensation of person height values when the device is mounted at a tilt.
- Working well even in low-light or completely dark environments with great lighting adaptability.
- Free from privacy concerns without image capturing.
- Support local data storage and data retransmission to collect data securely.
- Easy configuration via Wi-Fi for web GUI configuration.
- Function well with standard LoRaWAN<sup>®</sup> gateways and network servers.
- Quick and easy management with Milesight IoT Cloud.

# Chapter 3. Hardware Introduction

## Packing List

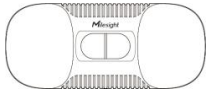

1 × VS135 Device

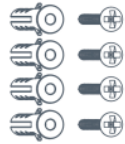

4 × Ceiling Mounting Kits



8 × Staff Tags

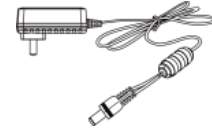

1 × Power Adapter



1 × Warranty Card

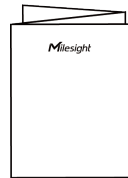

1 × Quick Guide



### Note:

1. The device supports mounting kits and people counter accessories. For more information, please scan the QR code.



2. If any of the above items is missing or damaged, please contact your sales representative.

## Hardware Overview

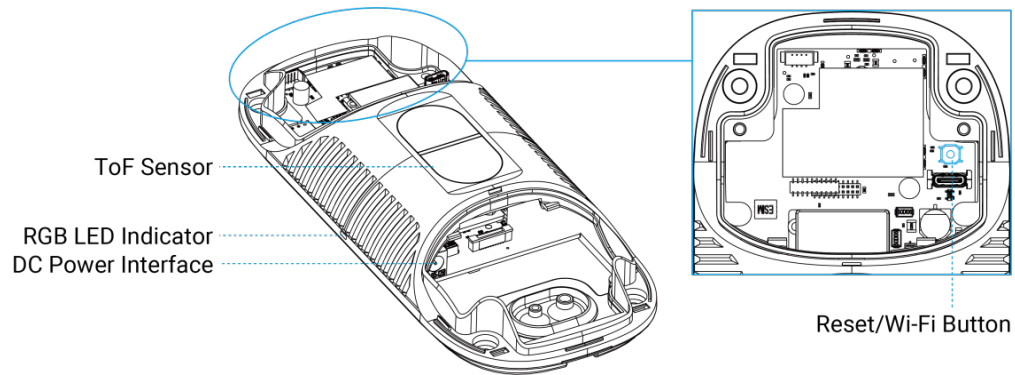

## Dimensions (mm)

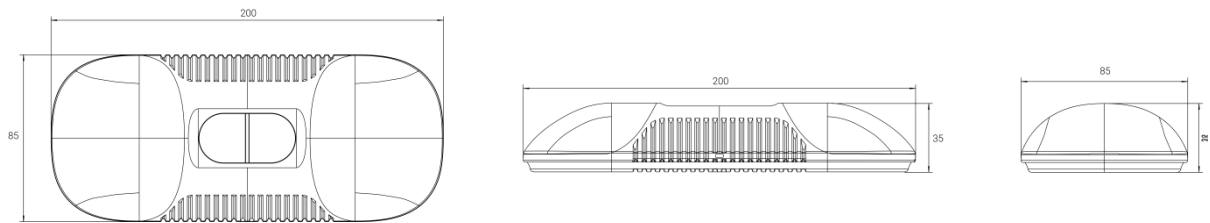

## Button and LED Indicators

Function	Action	LED Indication
Turn On/Off Wi-Fi	Press and hold the power button for more than 3 seconds.	Turn On/Off: Blue light blinks for 3 seconds. Wi-Fi On: Blue light on. Wi-Fi Off: Green light on.
Reset to Factory Default	Press and hold the reset button for more than 10 seconds.	Green light blinks until the reset process is completed.

# Chapter 4. Power Supply

VS135 can be powered by power adapter (12V DC, 2A).

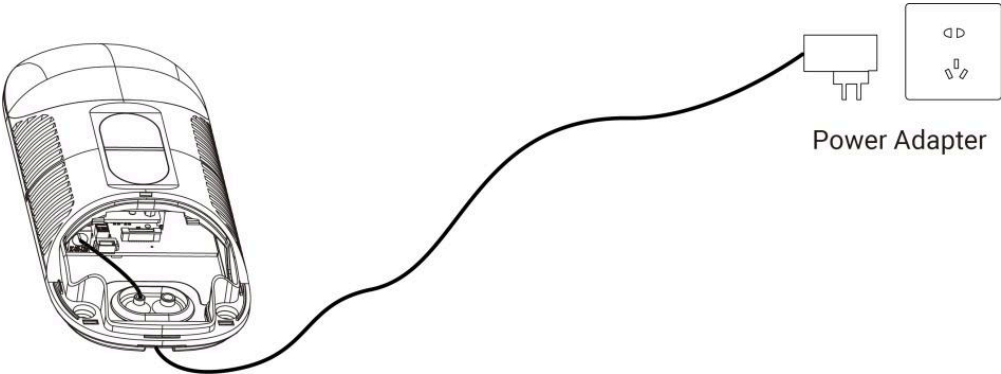

# Chapter 5. Installation

## Preparation before Installation

### Covered Detection Area

**Table 1. Parameter Definition**

Parameters	Explanation	Value
H	Installation height	Standard Version: $\leq 3.5$ m High Ceiling Mount: $\leq 6.5$ m
d	Minimum detection distance of device	Standard Version: 0.5 m High Ceiling Mount: 2 m
$\Delta d$	Distance measurement error of device	0.035 m
$h_{\max}$	Maximum pedestrian height	Example 1.8 m
h	Average pedestrian height	Example 1.7 m
$\alpha$	ToF horizontal field of view angle	Standard Version: $98^\circ$ High Ceiling Mount: $60^\circ$
$\beta$	ToF vertical field of view angle	Standard Version: $80^\circ$ High Ceiling Mount: $45^\circ$
x	Length of detection range	$2.300 \times (H-h)$
y	Width of detection range	$1.678 \times (H-h)$

- The maximum installation height is 3.5 m and the minimum installation height is  $h_{\max}+d+\Delta d$ . For example, when the maximum pedestrian height is 1.8 m, then the minimum installation height is  $1.8+0.5+0.035=2.335$  m.
- The maximum installation height is 6.5 m and the minimum installation height is  $h_{\max}+d+\Delta d$ . For example, when the maximum pedestrian height is 1.8 m, then the minimum installation height is  $1.8+2+0.035=3.835$  m.

The monitored area refers to the range visible to the device, which is displayed on the dashboard; the detection area, which is smaller, refers to the range within the monitored area where the device can detect changes in the number of people.

The detection area depends on the device's field of view angle, installation height, and target height. The following figure uses the horizontal field of view angle, an installation height of 3 meters, and a target height of 1.75 meters as an example for illustration:

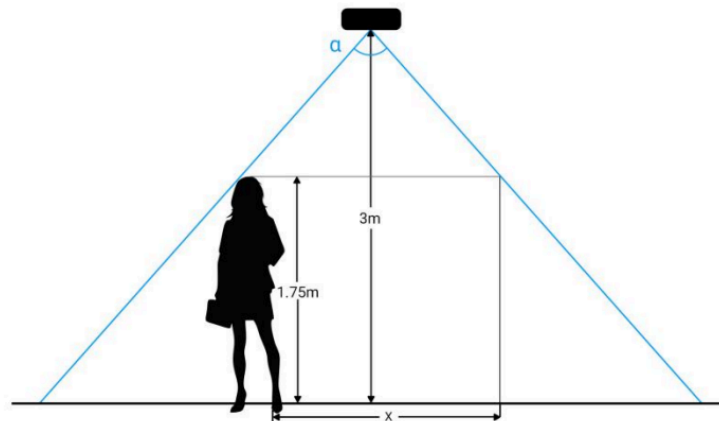

For example, if the pedestrians' height is 1.75 m, the detection area corresponding to each installation height is as follows:

**Table 2. Standard Version:**

Installation Height (m)	Monitored Area (m)	Detection Area(m)
2.5	5.75 × 4.20	1.84 × 1.34
2.6	5.98 × 4.36	2.07 × 1.51
2.7	6.21 × 4.53	2.30 × 1.68
2.8	6.44 × 4.70	2.53 × 1.85
2.9	6.67 × 4.87	2.76 × 2.01
3.0	6.90 × 5.03	2.99 × 2.18
3.1	7.13 × 5.20	3.22 × 2.35
3.2	7.36 × 5.37	3.45 × 2.52
3.3	7.59 × 5.54	3.68 × 2.69

Installation Height (m)	Monitored Area (m)	Detection Area(m)
3.4	7.82 × 5.71	3.91 × 2.85
3.5	8.05 × 5.87	4.14 × 3.02

**Table 3. High Ceiling Mount Version:**

Installation Height (m)	Monitored Area (m)	Detection Area(m)
3.5	4.04 × 2.90	2.08 × 1.49
3.7	4.27 × 3.07	2.31 × 1.66
3.9	4.50 × 3.23	2.54 × 1.82
4.1	4.73 × 3.40	2.77 × 1.99
4.3	4.97 × 3.56	3.00 × 2.15
4.5	5.20 × 3.73	3.23 × 2.32
4.7	5.43 × 3.89	3.46 × 2.49
4.9	5.66 × 4.06	3.70 × 2.65
5.1	5.89 × 4.22	3.93 × 2.82
5.3	6.12 × 4.39	4.16 × 2.98
5.5	6.35 × 4.56	4.39 × 3.15
5.7	6.35 × 4.72	4.62 × 3.31
5.9	6.81 × 4.89	4.85 × 3.48
6.1	7.04 × 5.05	5.08 × 3.65
6.3	7.27 × 5.22	5.31 × 3.81
6.5	7.51 × 5.38	5.54 × 3.98

## Installation Position

- Avoid installing the device against the wall and ensure that the distance between the device and the wall as follows:

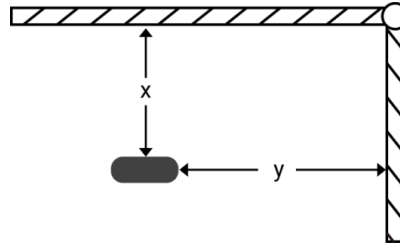

Condition	Standard Environment	The carpet/floor is Dark (need to set max noise filtering level)
<b>Normal imaging</b>	$x > 50\text{cm}$ , $y > 60\text{cm}$	$x > 50\text{cm}$ , $y > 75\text{cm}$
<b>Normal counting</b>	$x > 50\text{cm}$ , $y > 50\text{cm}$	$x > 50\text{cm}$ , $y > 50\text{cm}$

- When you install devices on the top of swinging doors, it is suggested to keep the door normally open. If the door must be normally closed, please install the device on the other side of the door to keep away from the door movement. And it is suggested to keep away from the door with a distance of at least 40 cm.

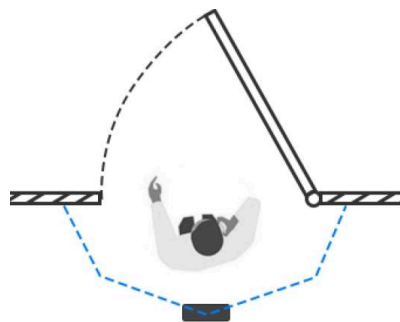

- Ensure that there are no other objects blocking the ToF light within a 50 cm radius of the front of the device.
- When it is necessary to install into the semi-outdoor environment, the distance from the long side of the device to the edge of the installation plane should be more than 20cm, and the short side should be more than 30cm.

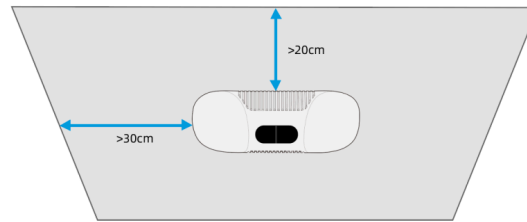

- Ensure that the ToF sensor is facing down and the tilt angle from the ground is no greater than 15° for the standard version, and no greater than 10° for the high ceiling mount version.
- Avoid direct Infrared LED light in the detection area.
- Not suggested to install the sensor close to glass or mirror.

## Environment Requirements

- Avoid 940nm light which may result in incorrect counting.
- Outdoor sunlight shining on the over channel will not have any effect, but the mirrored reflections that allow sunlight to shine on the ToF Sensor should be avoided.
- Make sure there are no obstacles within the live view of device. Otherwise, the device imaging may appear abnormally red or it will affect people counting. Set the appropriate noise filtering level according to the actual image. The more difficult it is to see the target, the higher the filter value should be.

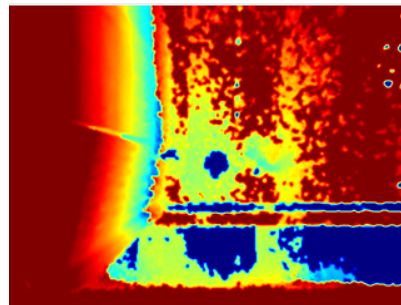

## Installation Step



### Note:

Check that the device and accessories are complete according to the **Quick Start Guide** in the unit's box.

### Ceiling Mount

Installation condition: ceiling thickness > 30mm.

**Step 1:** Take down the side covers.

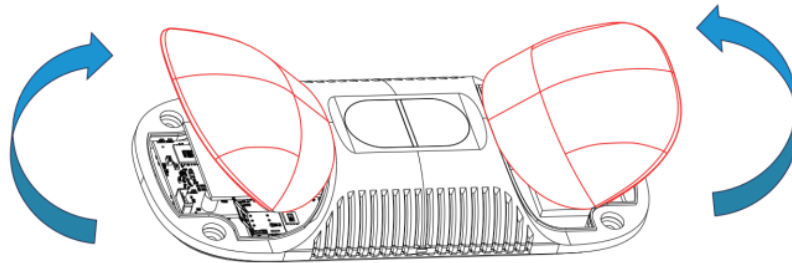

**Step 2:** Fix wall plugs into ceiling holes.

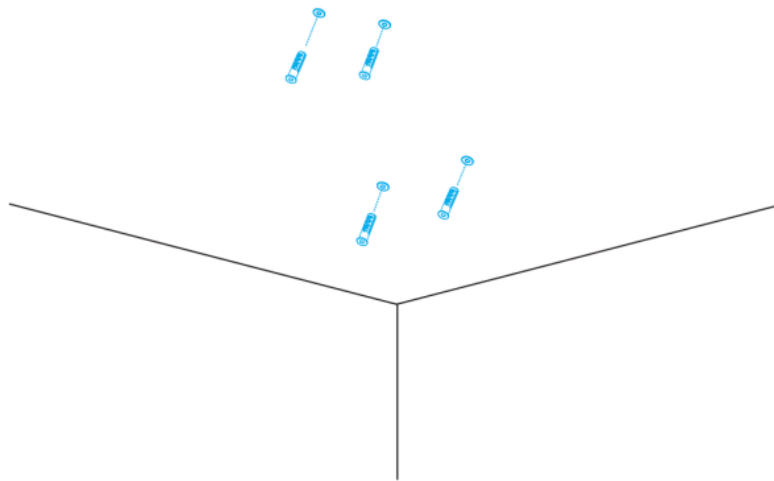

**Step 3:** Remove rubber plugs on the rubber sleeve, connect all required wires.

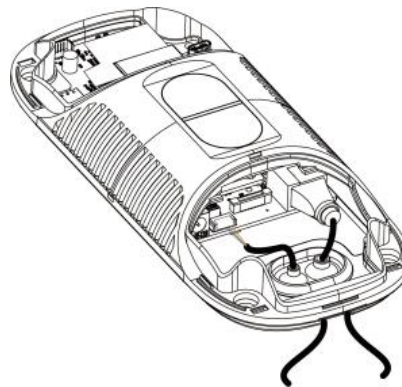

**Note:**

- Remove the rubber sleeve if waterproof is not required for easy installation.
- Use round wires.



- Ensure the rubber sleeve and the bottom cover are tightly connected without a gap if waterproof is required; if necessary, wrap the waterproof tapes around the wires to avoid any gap.
- Tighten the wires to avoid contact with internal modules.

**Step 4:** Fix the device to ceiling with mounting screws.

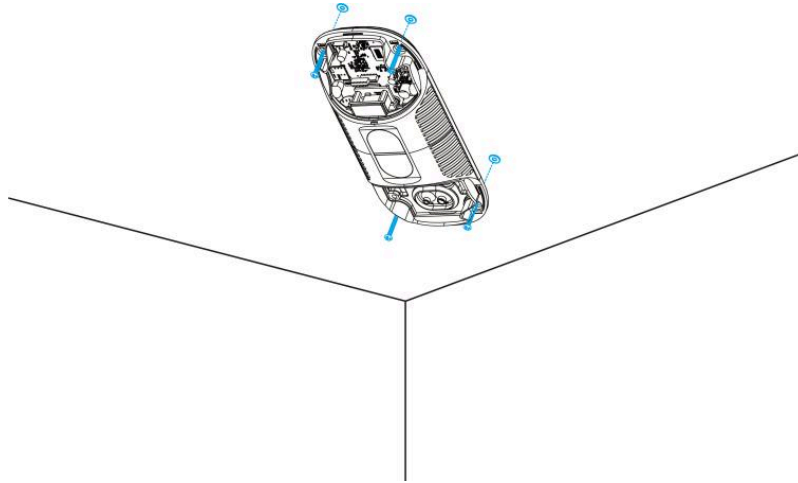

**Step 5:** Restore side covers.

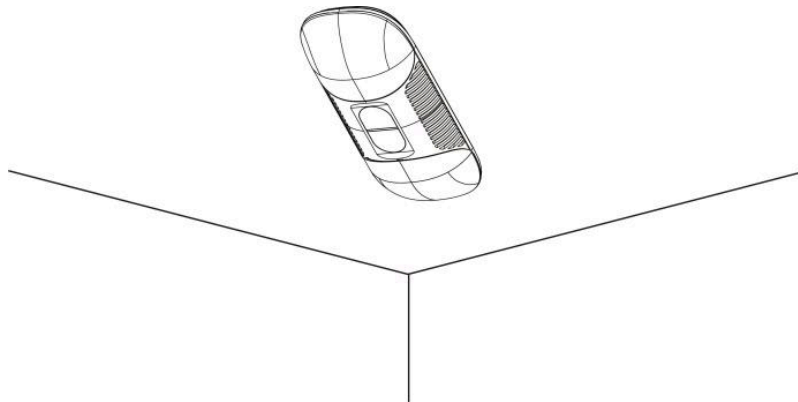

## Factors Affecting Accuracy

- Wearing a fisherman's hat or carrying a cardboard box on the shoulder: The target will not be recognized because it will become unlike a human in depth map.
- Handheld or cart-carrying a humanoid doll with sufficient height to pass by: The doll will be mistakenly detected as people because it is human-like in depth map.

## Chapter 6. Access the Sensor

The device provides user-friendly web GUI for configuration and users can access it via Wi-Fi connection. The recommended browsers are Chrome and Microsoft Edge. The default IP of Wi-Fi is **192.168.1.1**, and default SSID is **People Counter\_XXXXXX** (can be found on the label).

**Step 1:** Power on the device.

**Step 2:** Enable the Wireless Network Connection on your computer and search for corresponding access point, then connect computer to this access point.

**Step 3:** Open the Browser and type 192.168.1.1 to access the web GUI.

**Step 4:** Users need to set the password and three security questions when using the sensor for the first time.

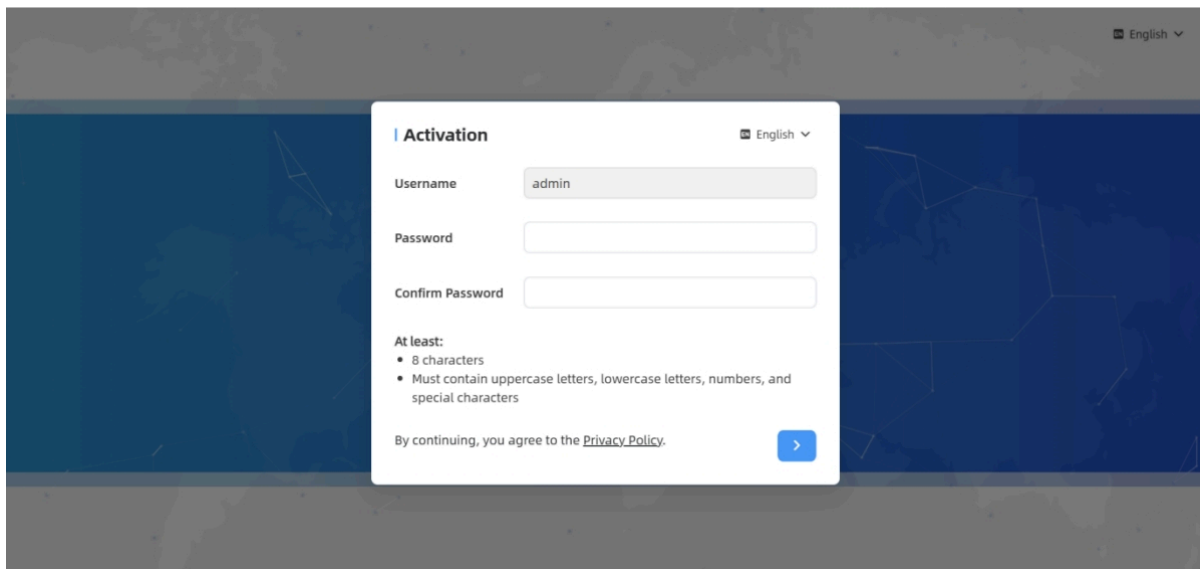

English

**Activation** English

Username

Password

Confirm Password

At least:

- 8 characters
- Must contain uppercase letters, lowercase letters, numbers, and special characters

By continuing, you agree to the [Privacy Policy](#).

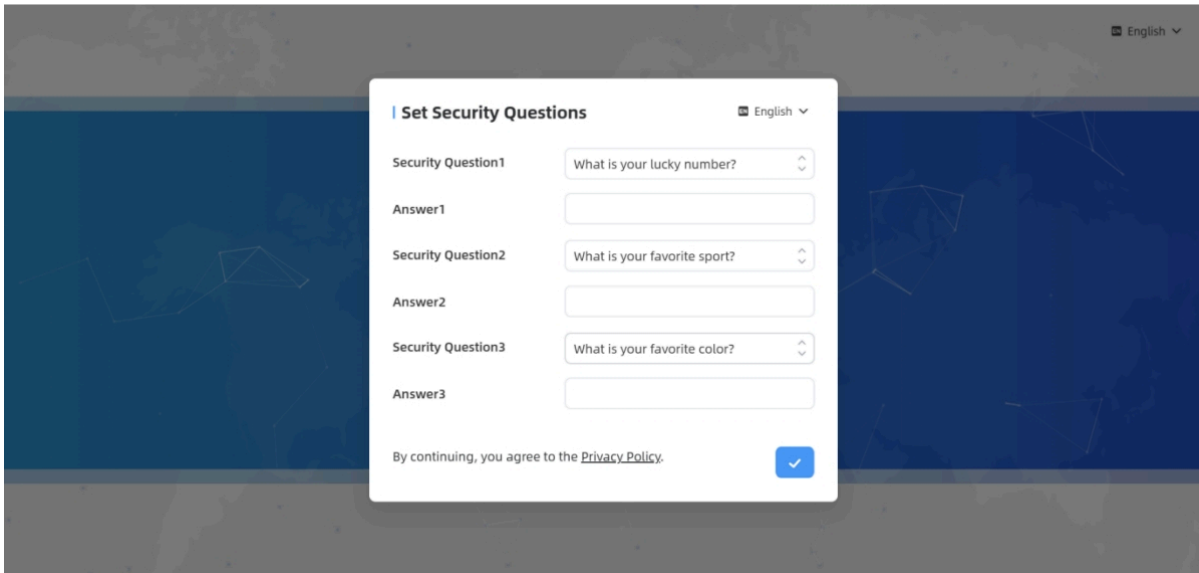

**Step 5:** After configuration, log in with username (admin) and custom password.

**Step 6:** Set the Wi-Fi password.

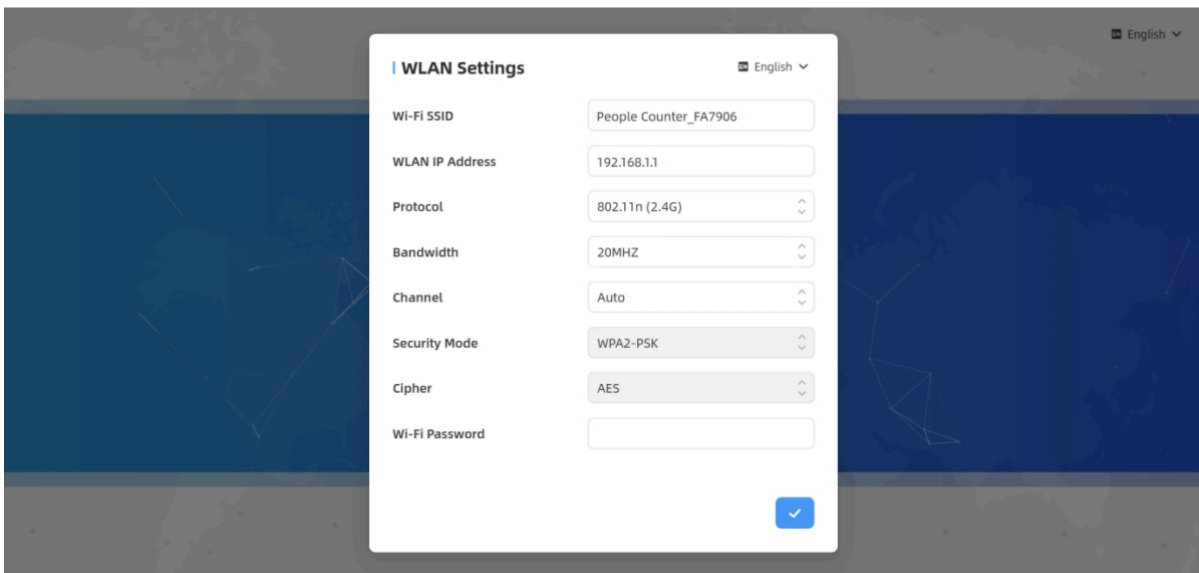



**Note:**

1. Logion password and Wi-Fi password must be 8 to 63 characters long and contain numbers, lowercase letters, uppercase letters and special characters. If the password is entered incorrectly five times, the account will be locked for 10 minutes.
2. It is recommended that users regularly update their passwords to enhance device security and prevent unauthorized access.
3. You can click the “forgot password” in login page to reset the password by answering three security questions when you forget the password if you set the security questions in advance.

# Chapter 7. Operation Guide

## Basic Counting Settings

To ensure proper device operation, users are required to complete the basic counting settings first, which includes setting deployment parameters, device strategies, enable line crossing or region people counting.

### Deployment Parameters

Deployment parameters typically include the installation height of the device, the height of the target to be counted, and the corresponding target height setting when other counting strategies are enabled.

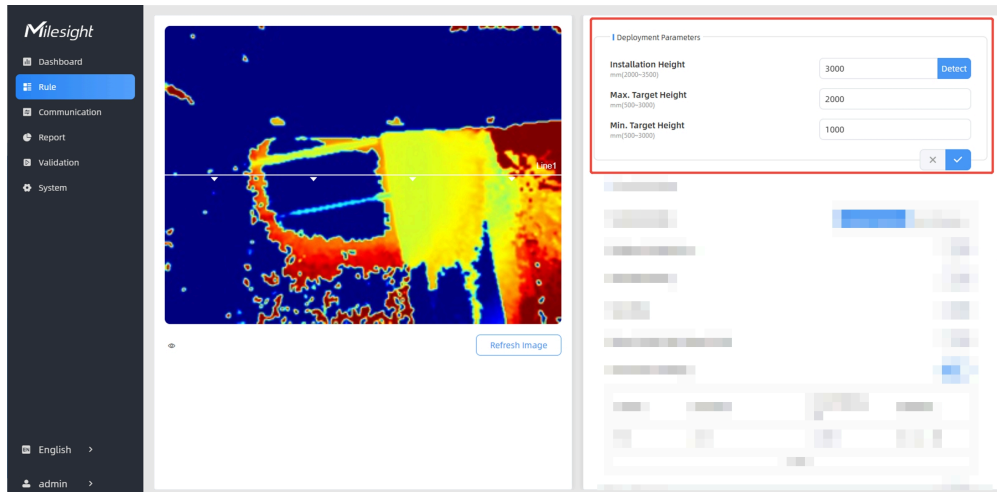

Parameters	Description
Installation Height	<p>Set the device installation height. Click <b>Detect</b> to detect the current installation height automatically.</p> <div style="background-color: #e0f2f1; padding: 10px; border-radius: 5px;"> <p> <b>Note:</b></p> <ol style="list-style-type: none"> <li>1. Ensure that there is no object directly below the device avoiding interfering the height detection.</li> <li>2. The automatic detection of the installation height is not supported with dark floor/carpet (black, grey, etc.)</li> </ol> </div>

Parameters	Description
Max. Target Height	Set the maximum target height, then the device will ignore the objects higher than this setting value.
Min. Target Height	Set the minimum target height, then the device will ignore the object shorter than this setting value.
Child Filter Height	Set the max child height when children distinction feature is enabled.



**Note:**

Due to the error in ToF distance measurement (0.035 m), the Max. Target Height should be set as maximum pedestrian height plus 0.035 m and the Min. Target Height as minimal pedestrian height minus 0.035 m in the actual applications.

**Example:**

if the pedestrian height is 1.6 m to 1.8 m, the Max. and Min. Target Height should be configured as 1.835 m and 1.565 m respectively.

## Device Strategies

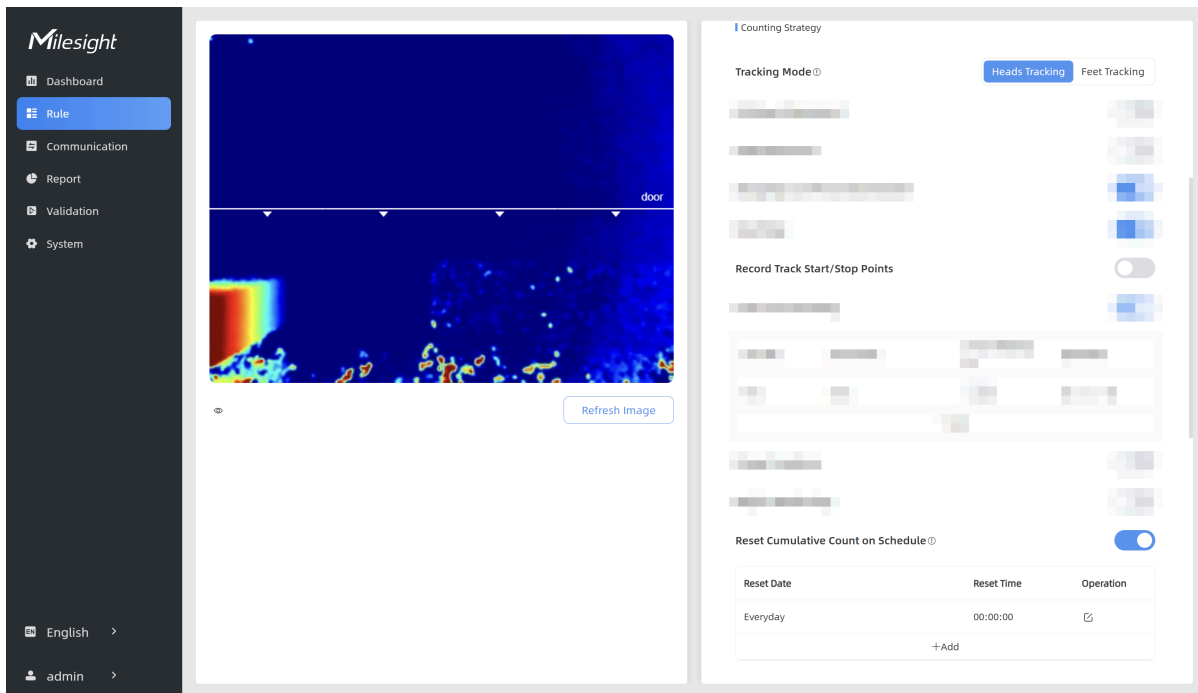

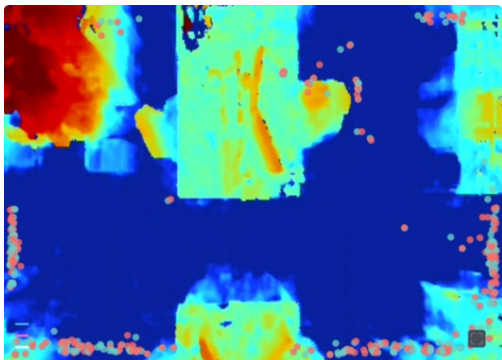
Parameters	Description
Tracking Mode	<p>Select the tracking mode of counting, including Heads Tracking and Feet Tracking:</p> <p>When the device detects both feet of the target in the FOV, it generates a trajectory line based on the movement path of the feet.</p> <p>When the target's head and shoulders are detected, a corresponding trajectory line is generated according to the movement path of the head and shoulders.</p> <div data-bbox="630 667 1416 840" style="border: 1px solid #ccc; border-radius: 10px; background-color: #e6f2ff; padding: 10px; margin-top: 10px;"> <p> <b>Note:</b> It is recommended to use heads tracking mode when the installation height is low in standalone working mode.</p> </div>
Record Track Start/Stop Points	<p>Enable to record the start track points and end track points of people in the live view for the position adjustment of the detection line. It can store 5000 track points at most, with green as the starting point and red as the stop point.</p> <div data-bbox="771 1066 1269 1423" style="text-align: center;">  </div>
Reset Cumulative Count on Schedule	<p>Enable to periodically reset cumulative count on schedule. Support up to 5 reset schedules.</p> <p>Cumulative Count includes:</p> <p>Total In/Out counting of each detection line.</p> <p>Max./Avg. Dwell Time of each detection region.</p> <p>Total Effective Audience and Avg. Attention Time of each attention region.</p>

Parameters	Description
Enhanced Detection Mode	<p>Turn on when any one of the following situations occurs, it will ensure normal counting and detecting:</p> <ul style="list-style-type: none"> <li>• The depth image is abnormal;</li> <li>• There is obstacle in the live view;</li> <li>• Installation conditions are not met.</li> </ul>

## Line Crossing Counting

Users can draw detection lines to count the number of people entering or exiting.



### Note:

1. Ensure that the detected target can pass through the detection line completely. It's recommended that the detection line is perpendicular to the In/Out direction and on the center of the detection area without other objects around.
2. Redundant identification spaces are needed on both sides of the detection line for the target detection. This ensures stable target recognition and tracking before crossing the detection line, which will make the detection and count more accurate.
3. It is recommended to draw the detection line as close to the center of the image as possible, and ensure that the target has already been detected before crossing the line.

**Step 1:** Please ensure that the [deployment parameters](#) and [device strategies](#) have been configured before using this feature.

**Step 2:** Find the list of detection lines. Click **+Add** to draw a new detection line or click  to edit the existed detection line on the live view.

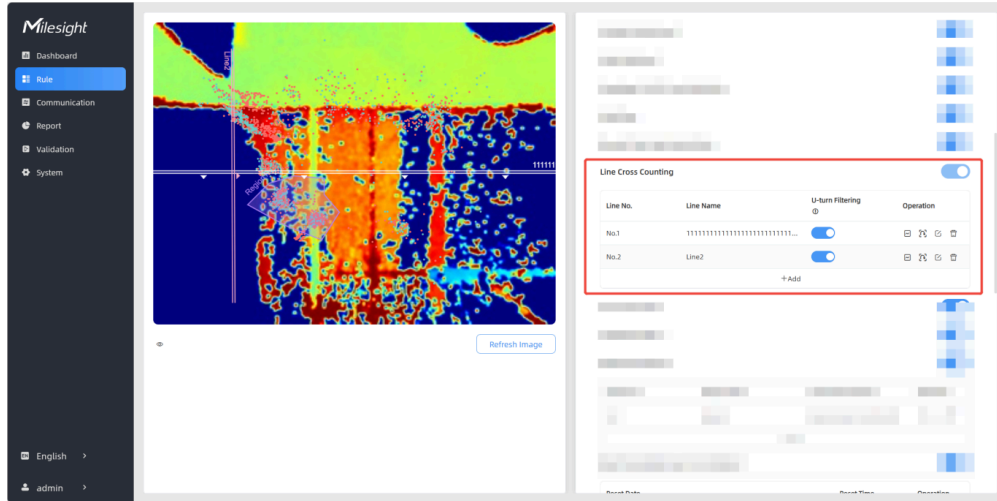

**Step 3:** Left-click to start drawing and drag the mouse to draw a line, left-click again to continue drawing a different direction edge, and right-click the mouse to complete the drawing. The line can be dragged to adjust the location and length. One device supports at most 4 broken lines with maximum 10 points each.

**Step 4:** If users want to redraw this line, click **Clear This Line** or drag the vertices of the broken line to adjust. The arrow direction of the detection line depends on your drawing direction. If users need to flip the line, click **Flip Arrow Direction**. Then click  to finish drawing.

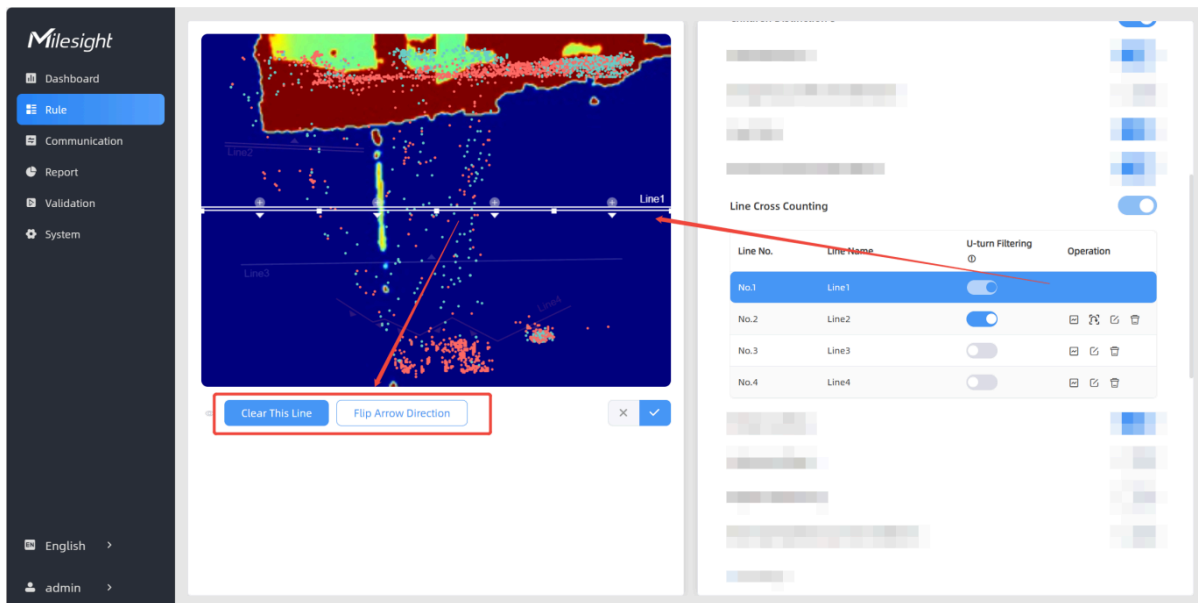

**Step 5:** Users can click  to customize the name of line. If users need to delete a certain line, click .

**Step 6:** Users can see the effect in [Dashboard](#).

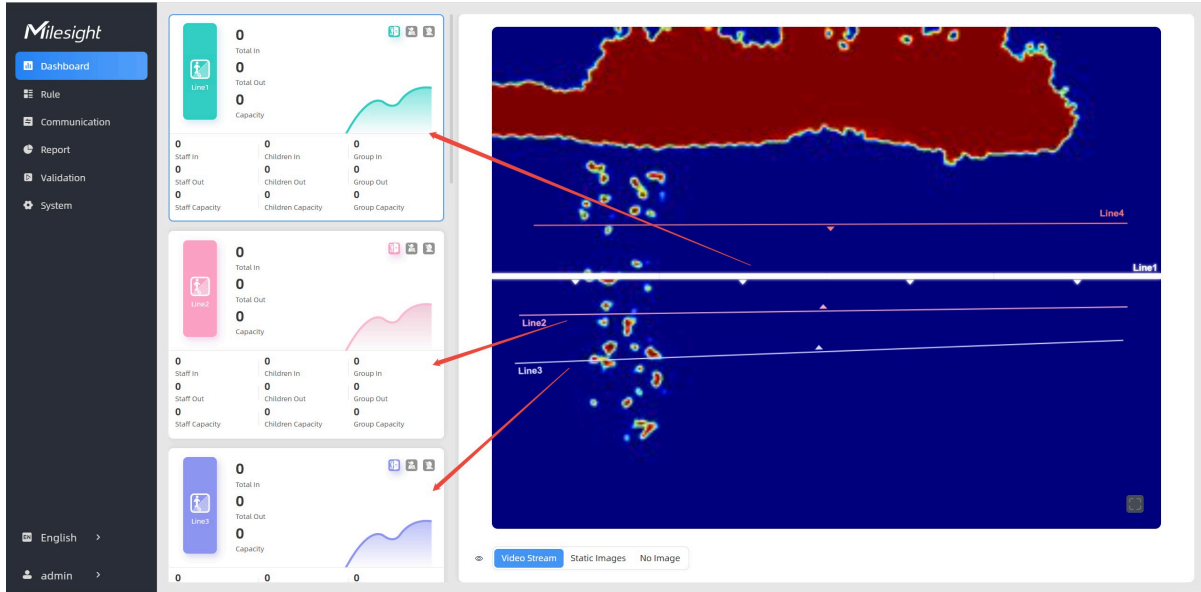

To view line's data for a certain time period and generate report, please refer to [Report](#).

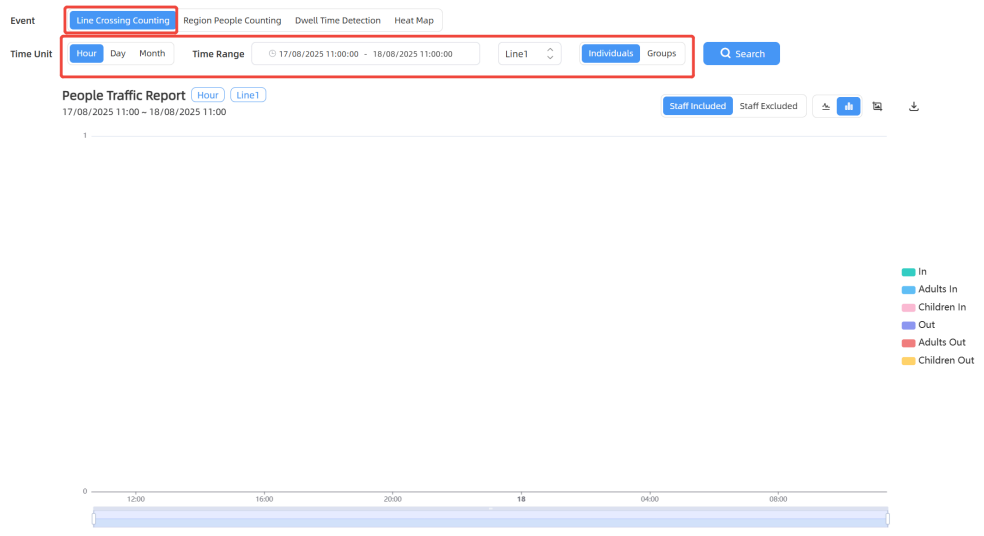

**Step 7: Data Report Setting.**

**Report Strategy**

**Periodic Report**

**Periodic Report Scheme** On the Dot From Now On

**Period**

**Trigger Report**

**Data Retransmission**

Parameters	Description
Periodic Report	Regularly report the number of people counted crossing a line or within a region based on time.
Periodic Report Scheme	Select the periodic report of "On the Dot" or "From Now On".
Period	<p><b>On the Dot:</b> Report at each integer moment. For example, current time is 0:07, when the interval is set to 10 minutes, it will report at 0:10, 0:20, 0:30, and so on.</p> <p><b>From Now On:</b> Begin reporting from this moment onwards and regularly report based on the interval cycle.</p>
Trigger Report	Report immediately when there is a change of the line crossing people counting number or region people counting number. For detailed report information, please refer to the <a href="#">Trigger Report</a> .
Data Retransmission	<p>Enable this feature to ensure the network server can receive all data even if the network is down for some time. The device supports up to 4000 historical records.</p> <p>Before using this feature, please follow below steps to complete the relevant prerequisites:</p> <p><b>Step 1:</b> Ensure the device time is correct. Please refer <a href="#">Time Configuration</a> to sync the time</p> <p><b>Step 2:</b> Go to <b>Communication &gt; LoRaWAN</b> to enable rejoin mode and set the number of packets sent.</p>  <p>For example, the device will send LinkCheckReq MAC packets to the network server regularly to check any network disconnection; if there is no response for 8+1 times, the join status will change to de-active and the device will record a data lost time point (the time it reconnected to the network).</p> <p><b>Step 3:</b> Ensure the device is always on-line and unplugged.</p>

Parameters	Description
	<p>After the network connection is restored, the device will send the lost data from the point in time when the data was lost according to the data retransmission interval (600s by default).</p> <div data-bbox="565 426 1414 892" style="background-color: #e6f2ff; padding: 10px; border-radius: 5px;"> <p> <b>Note:</b></p> <ol style="list-style-type: none"> <li>1. If the device is rebooted or re-powered when data retransmission is not completed, the interrupted retransmission data will be retransmitted first after the network is reconnected to the network, and then the newly triggered retransmission data will be transmitted.</li> <li>2. If the network is disconnected again during data retransmission, it will only send the latest disconnection data.</li> </ol> </div>

## Region People Counting

The device supports monitoring the number and the dwell time of people in the region, providing more valuable analysis data.

**Step 1:** Please ensure that the [deployment parameters](#) and [device strategies](#) have been configured before using this feature.

**Step 2:** Enable Region Monitoring. Click **+Add** to add the region monitoring on the live view. Up to 4 regions are supported with maximum 10 points each.

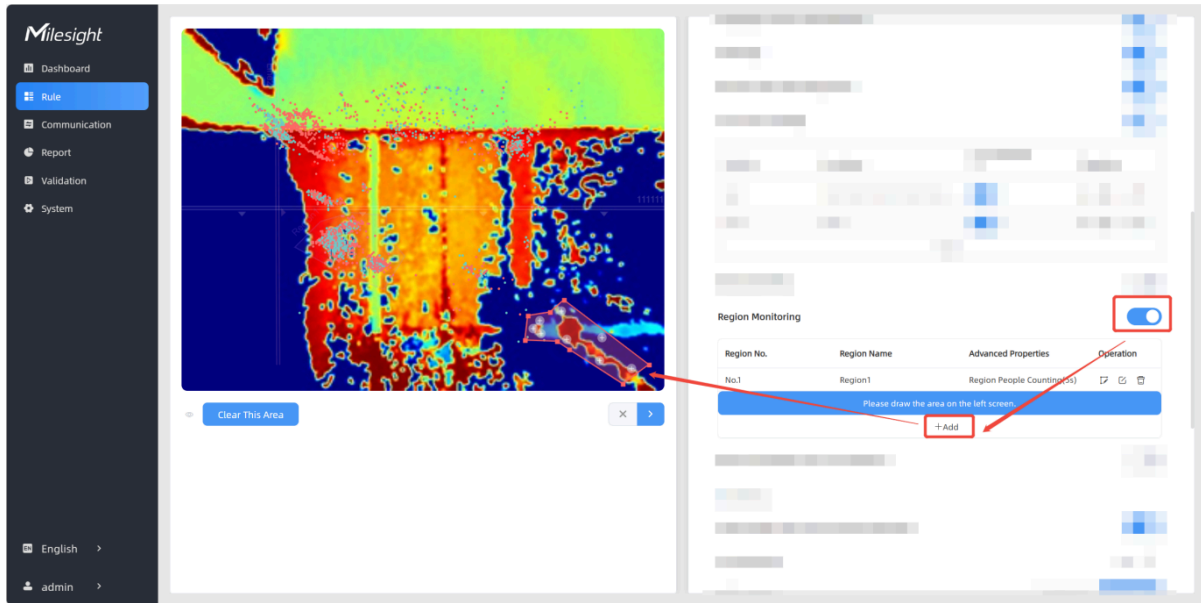

**Step 3:** Customize the zone name and enable Region People Counting or Dwell Time Detection as needed.

### Advanced Properties

Zone Name

Region People Counting

Pass-by Filtering   
s(0-3600)

Dwell Time Detection

Min. Dwell Time   
s(0-3600)

**Step 4:** The configuration is displayed in the list after the configuration is complete. You can redraw the areas by clicking the redraw button in the list. Click the edit button to modify the advanced settings of the areas or click delete button to delete the areas separately.

Region Monitoring <input checked="" type="checkbox"/>			
No.	Region Name	Advanced Properties	Operation
No.1	Region1	Region People Counting(5s)	<input type="button" value="✎"/> <input type="button" value="✏"/> <input type="button" value="🗑"/>
+ Add			

**Step 5:** Users can see the effect in [Dashboard](#).

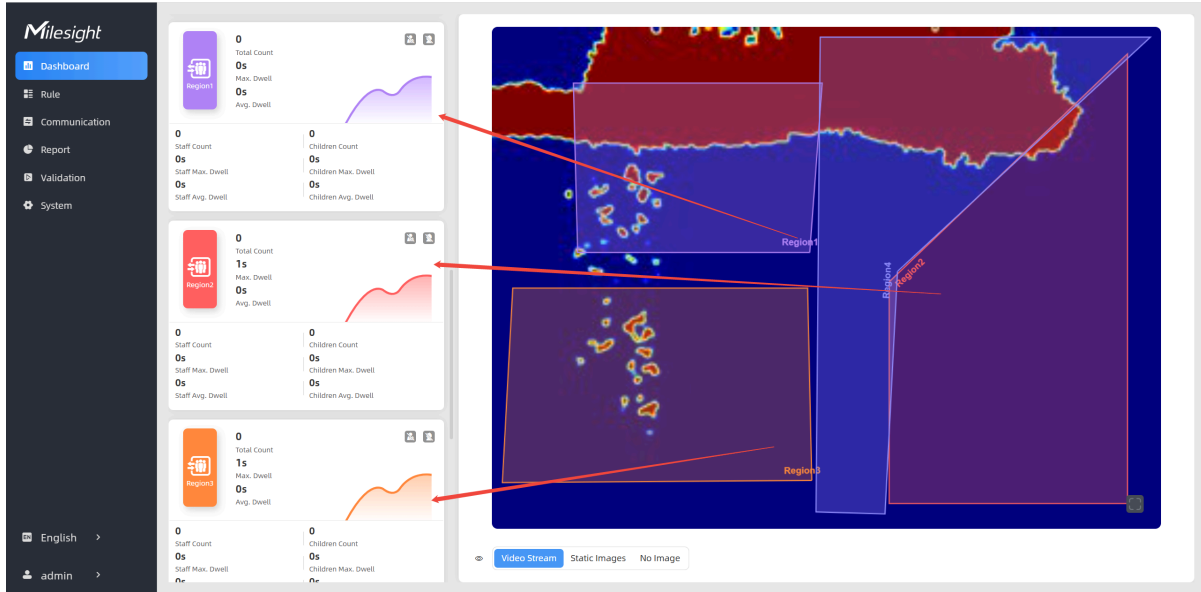

To view region's data for a certain time period and generate report, please refer to [Report](#).

Event: Line Crossing Counting, **Region People Counting**, Dwell Time Detection, Heat Map

Time Range: 17/08/2025 11:00:00 - 18/08/2025 11:00:00 | Region1 | Search

**People Counting Report** Region1  
17/08/2025 11:00 - 18/08/2025 11:00

Staff Included | **Staff Excluded** | [Print] | [Download]

- Count
- Adults Count
- Children Count

**Step 6: Data Report Setting.**

**Report Strategy**

**Periodic Report**

**Periodic Report Scheme** On the Dot | From Now On

**Period** 1h

**Trigger Report**

**Data Retransmission**

Parameters	Description
Periodic Report	Regularly report the number of people counted crossing a line or within a region based on time.
Periodic Report Scheme	Select the periodic report of "On the Dot" or "From Now On".
Period	<p><b>On the Dot:</b> Report at each integer moment. For example, current time is 0:07, when the interval is set to 10 minutes, it will report at 0:10, 0:20, 0:30, and so on.</p> <p><b>From Now On:</b> Begin reporting from this moment onwards and regularly report based on the interval cycle.</p>
Trigger Report	Report immediately when there is a change of the line crossing people counting number or region people counting number. For detailed report information, please refer to the <a href="#">Trigger Report</a> .
Data Retransmission	<p>Enable this feature to ensure the network server can receive all data even if the network is down for some time. The device supports up to 4000 historical records.</p> <p>Before using this feature, please follow below steps to complete the relevant prerequisites:</p> <p><b>Step 1:</b> Ensure the device time is correct. Please refer <a href="#">Time Configuration</a> to sync the time</p> <p><b>Step 2:</b> Go to <b>Communication &gt; LoRaWAN</b> to enable rejoin mode and set the number of packets sent.</p>  <p>For example, the device will send LinkCheckReq MAC packets to the network server regularly to check any network disconnection; if there is no response for 8+1 times, the join status will change to de-active and the device will record a data lost time point (the time it reconnected to the network).</p> <p><b>Step 3:</b> Ensure the device is always on-line and unplugged.</p>

Parameters	Description
	<p>After the network connection is restored, the device will send the lost data from the point in time when the data was lost according to the data retransmission interval (600s by default).</p> <div data-bbox="565 426 1414 892" style="background-color: #e6f2ff; padding: 10px; border-radius: 5px;"> <p> <b>Note:</b></p> <ol style="list-style-type: none"> <li>1. If the device is rebooted or re-powered when data retransmission is not completed, the interrupted retransmission data will be retransmitted first after the network is reconnected to the network, and then the newly triggered retransmission data will be transmitted.</li> <li>2. If the network is disconnected again during data retransmission, it will only send the latest disconnection data.</li> </ol> </div>

## Advance Property Settings

The advanced property function uses AI recognition to intelligently distinguish various target properties. Before using the advanced property function, please ensure that you have completed the setting of the [basic counting function](#).

### Children Distinction

The device identifies individuals below the child filter threshold as children.

**Step 1:** Enable **Children Distinction**, it will display the development parameters for child filter height.

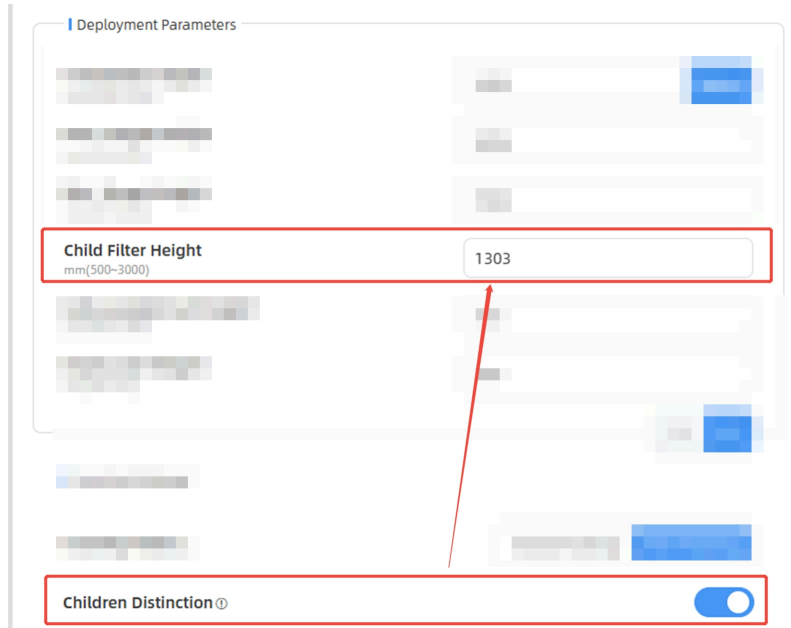

**Step 2:** Enter a threshold value, anyone with a height below this will be identified as a child by the device.

Then click  to finish configuration.

**Step 3:** Users can see the effect in [Dashboard](#).

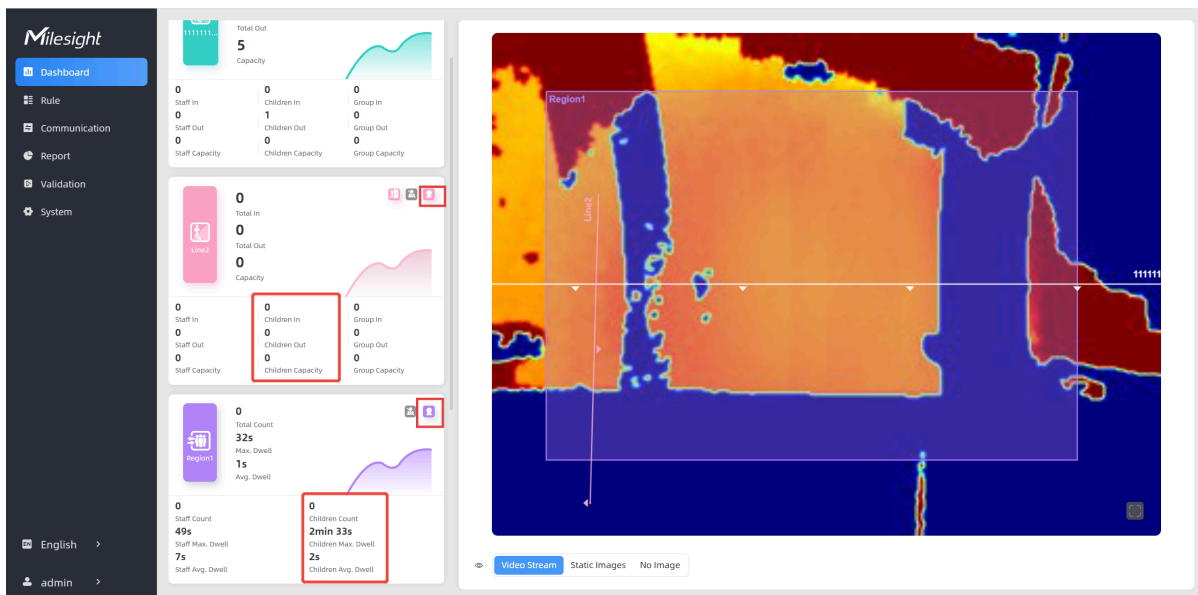

To view children's data for a certain time period and generate report, please refer to [Report](#).

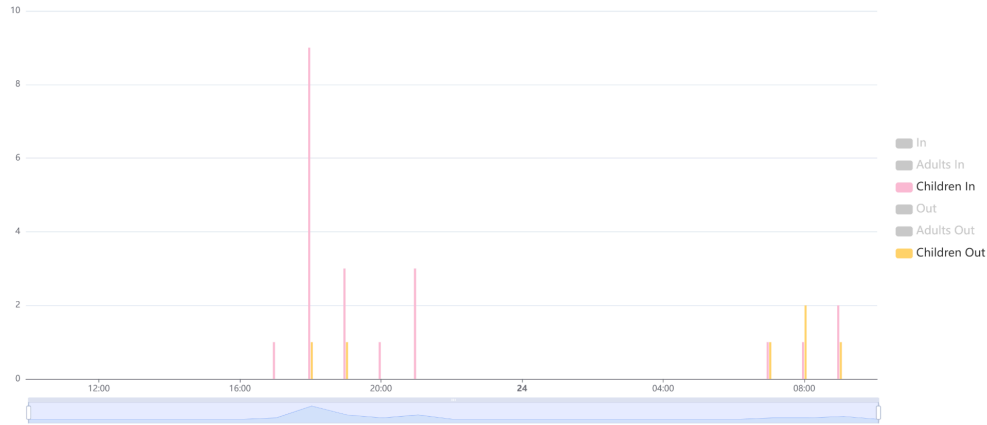

### Note:

- This function is only applicable for line cross people counting.
- LoRa reporting only transmit group counting data when group counting function is enabled.
- Children under 1.1m in height, children in strollers/shopping carts, children being held, and children covered by an adult have a probability of undercounting.

## Staff Detection

The device will detect staff members who wear a designated accessories.



### Important:

1. Dark floor/carpet (black, grey, etc.) will affect the device to count staffs when Staff Detection is enabled.

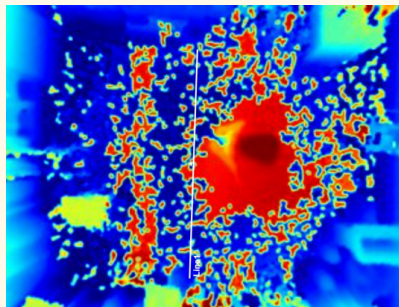

**Step 1:** Check the optional accessories are complete in the unit's box. For optimal detection, it is suggested to use the staff accessories provided by Milesight.

Have staffs wear Staff Tags on the visible parts (neck, shoulders, etc.).

Reflective stripe requirements: width > 2cm, 500 cd/lux.m<sup>2</sup>

**Step 2: Enable Staff Detection.**

**Step 3: Users can see the effect in Dashboard.**

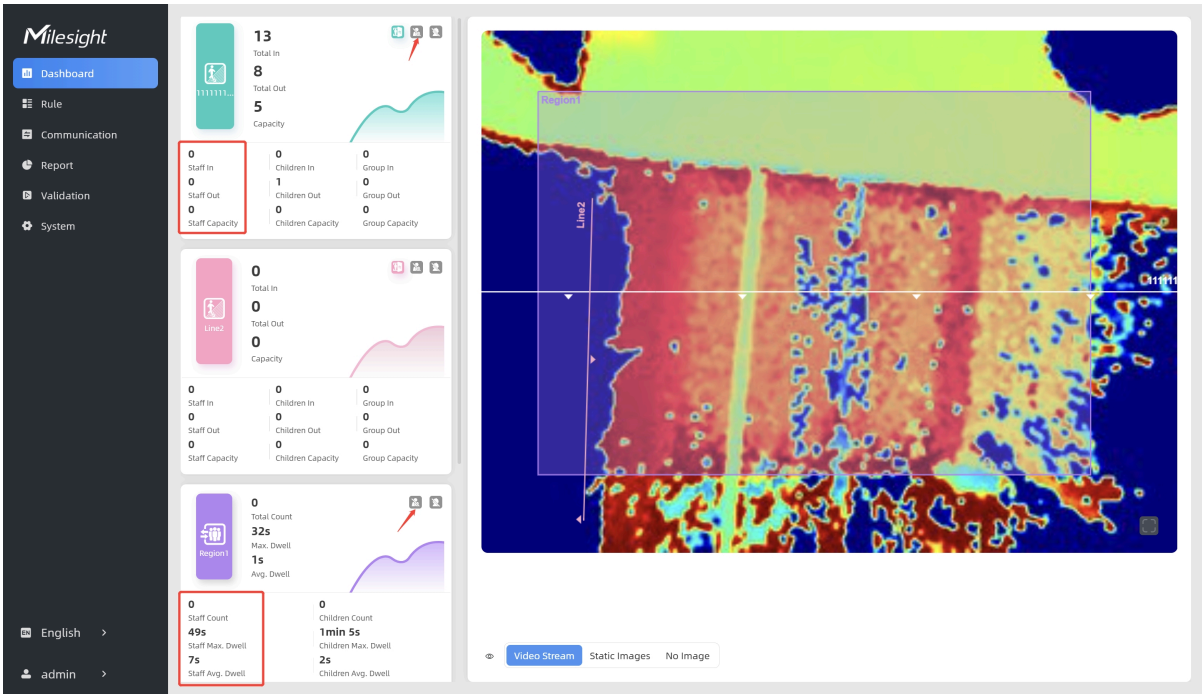

To view staffs' data for a certain time period and generate report, please refer to [Report](#).

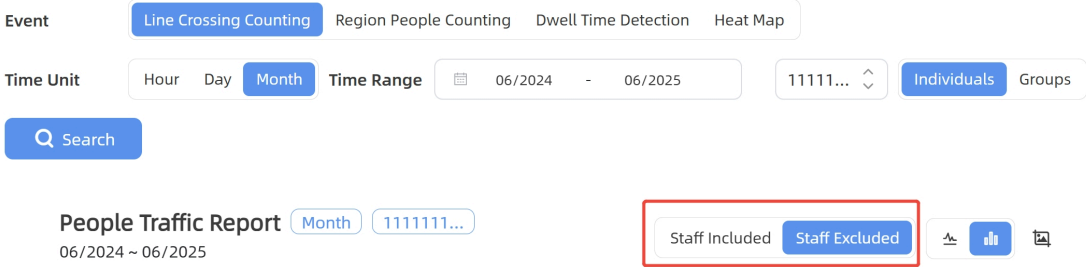

### Group Counting

The device is capable of simultaneously recognizing and counting multiple people entering or passing through the detection area during the same period of time. By analyzing distance, movement direction, and speed differences, it provides deeper insights into customers' behaviors. **This function is only applicable for line cross people counting.**

When group counting is enabled, the accumulated and periodic counts in the [periodic report packet](#) are replaced by the accumulated group count and periodic group count. The original accumulated and periodic counts continue to be recorded internally. When the group counting function is disabled, the periodic report packet reverts to reporting the accumulated and periodic counts.

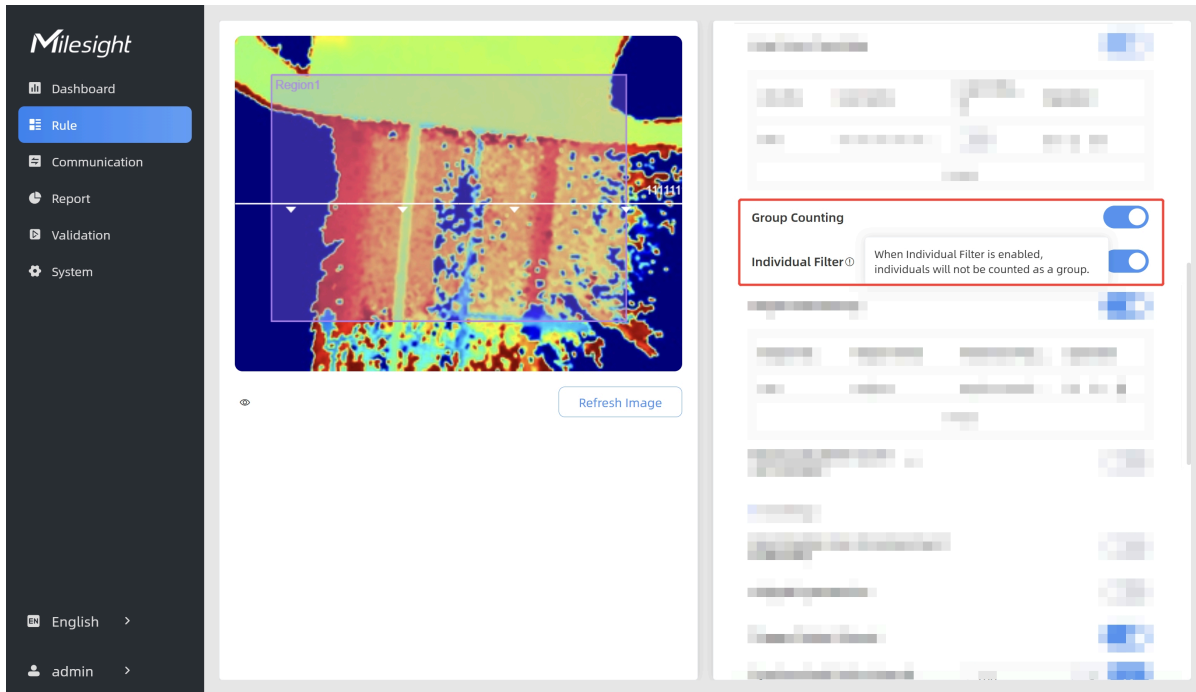

**Step 1:** Click to enable the **group counting** function, the device considers a group of people as a single group.

**Step 2:** Choose to enable or disable **Individual Filter**. When enabled, device will only count two or more individuals as a group.

**Step 3:** Users can see the effect in [Dashboard](#) .

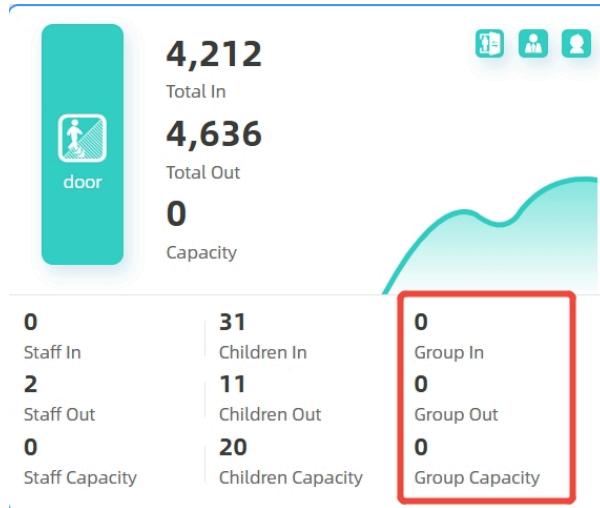

To view groups' data for a certain time period and generate report, please refer to [Report](#).

Event: **Line Crossing Counting** | Region People Counting | Dwell Time Detection | Heat Map

Time Unit: **Hour** | Day | Month | Time Range: 22/06/2025 07:00:00 - 23/06/2025 07:00:00

**Individuals** | Groups | Shopping Cart |

## U-turn Filtering

The device supports the U-turn filtering function, filtering out the people who are actually not in / out of the entrance, to avoid repeated counting. Users can draw an area for every line and the device will count the In and Out values only when people pass this area.

### Disable U-turn filtering:

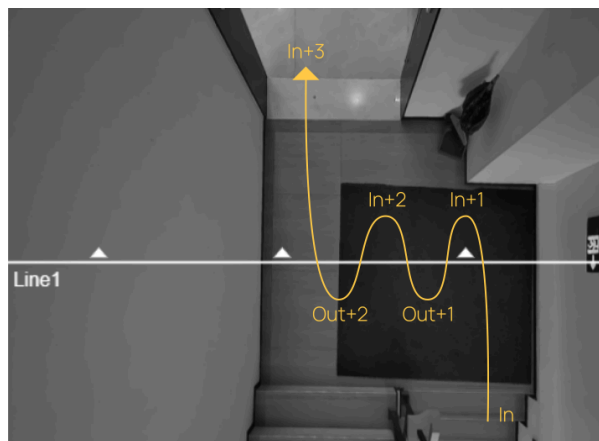

**Enable U-turn filtering:**

The device automatically filters out the wandering crowd in the live view.

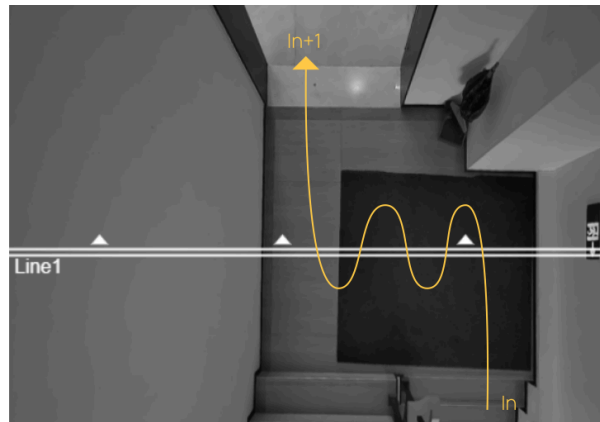

**Enable U-turn filtering & Draw areas:**

When you care about the timeliness of the statistics, you can choose to draw the U-turn area.

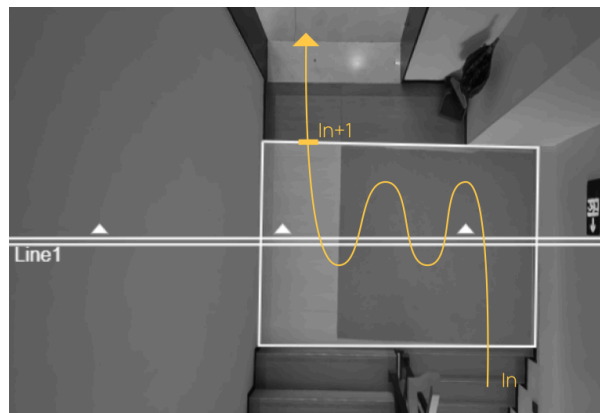

***The above illustration is for reference only, here are the steps to draw the U-turn area:***

**Step 1:** Enable U-turn Filtering to filtering repeated counting.

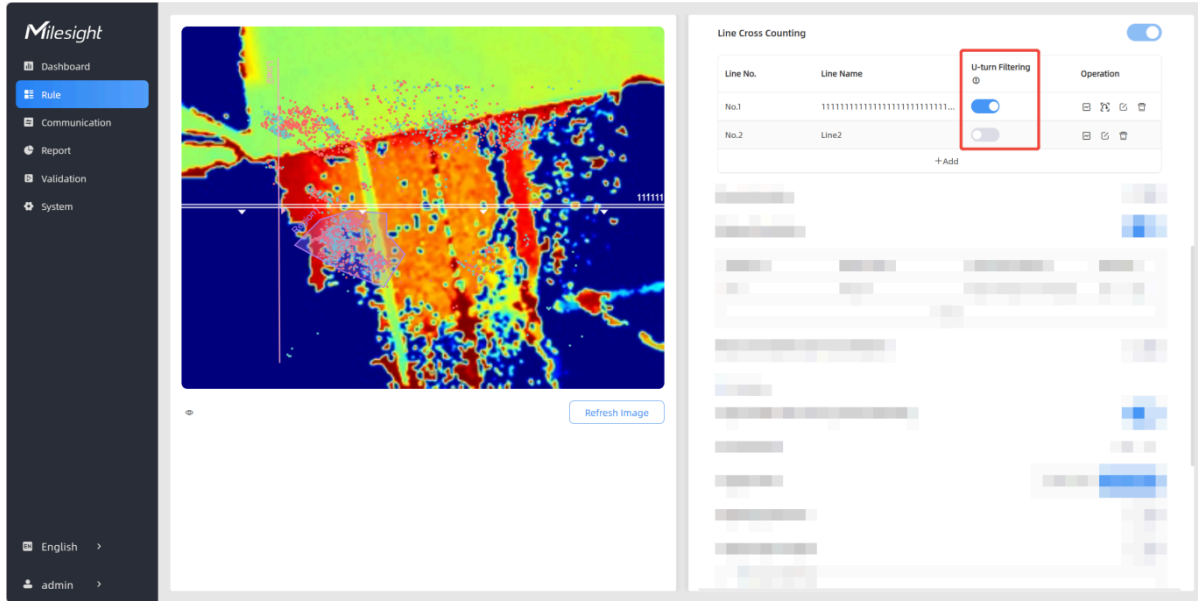

If you requires to use U-turn area filtering, please continue below steps:

**Step 2:** Click  to edit U-turn areas for existed detection line on the live view.

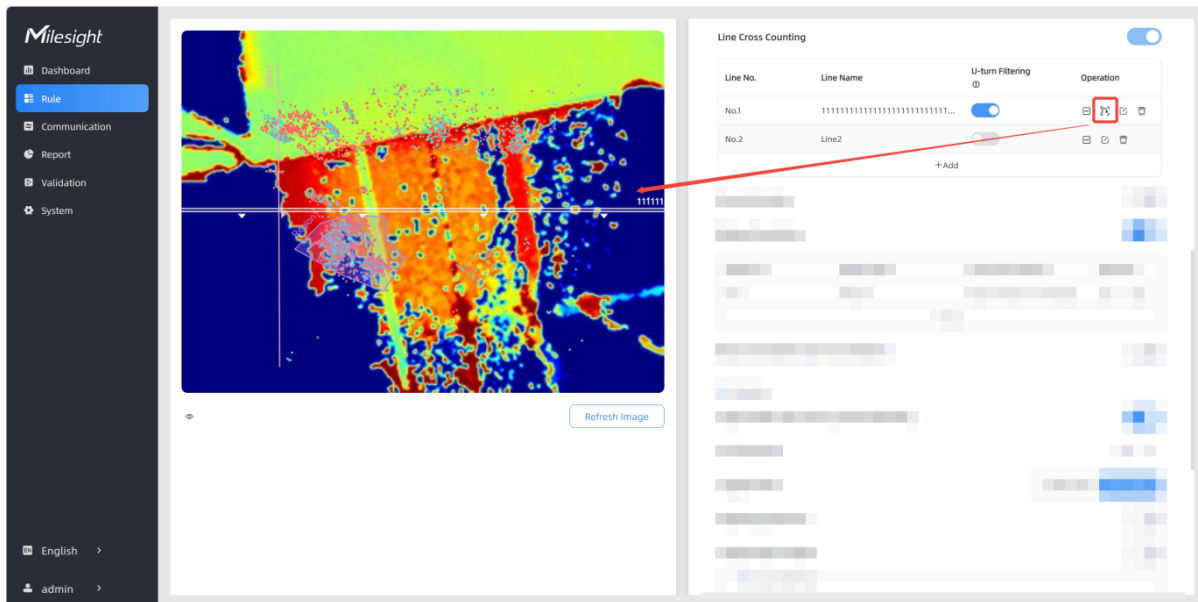

**Step 3:** Left-click to start drawing and drag the mouse to draw an edge. Then left-click again to continue drawing a different direction edge. Right-click the mouse to complete the drawing. The area can be dragged to adjust the location and length. One device supports up to 4 areas with maximum 10 segments each.



## Occlusion Settings

Occlusion Detection can be enabled in the event of an occlusion so that the sensor can be detected in time if it has been maliciously occluded. Alarms are issued when occlusion occurs, and notification of deactivation is given when occlusion is lifted.

**Step 1:** Enable **Occlusion Detection** when you notice that the device's FOV is blocked.

**Step 2:** Drag Occlusion Proportion progress bar, adjust the threshold for the percentage of the entire field of view that must be occluded to trigger an alarm. Default: 50%.

Drag Sensitivity Level progress bar, adjust the sensitivity of the occlusion trigger. The higher the level, the easier it is to detect occlusion, but the false alarm rate increases. Default: 2.

Fill in Continuous Occlusion time, set the duration the sensor must be obscured before an alarm is issued.

**Step 3:** Click  to complete the configuration.



### Note:

1. Not recommended for use in environments with black carpets.
2. When multi-device stitching mode is enabled, the occlusion setting parameters of the master and node devices are synchronized. Regardless of which device is masked, the master device will trigger the alarm.

## Obstacle Exclusion

When there is an immovable static obstacle within the detection range of the device, and the detection line or region cannot be adjusted to avoid the obstacle, this function can be activated to filter out obstacles similar to humans.

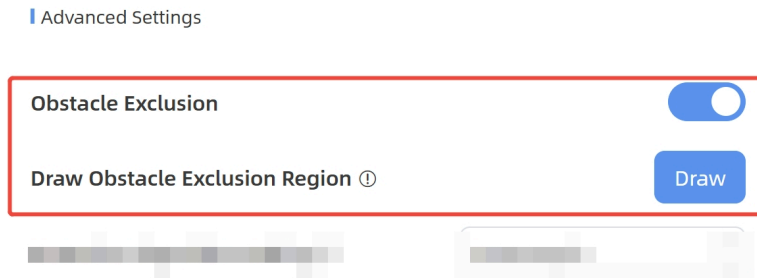

**Step 1:** Enable **Obstacle Exclusion**, click **Draw** button.

**Step 2:** Left-click the live view to start drawing and drag the mouse to draw an edge. Left-click again to continue drawing a different direction edge. Right-click the mouse to complete the drawing.

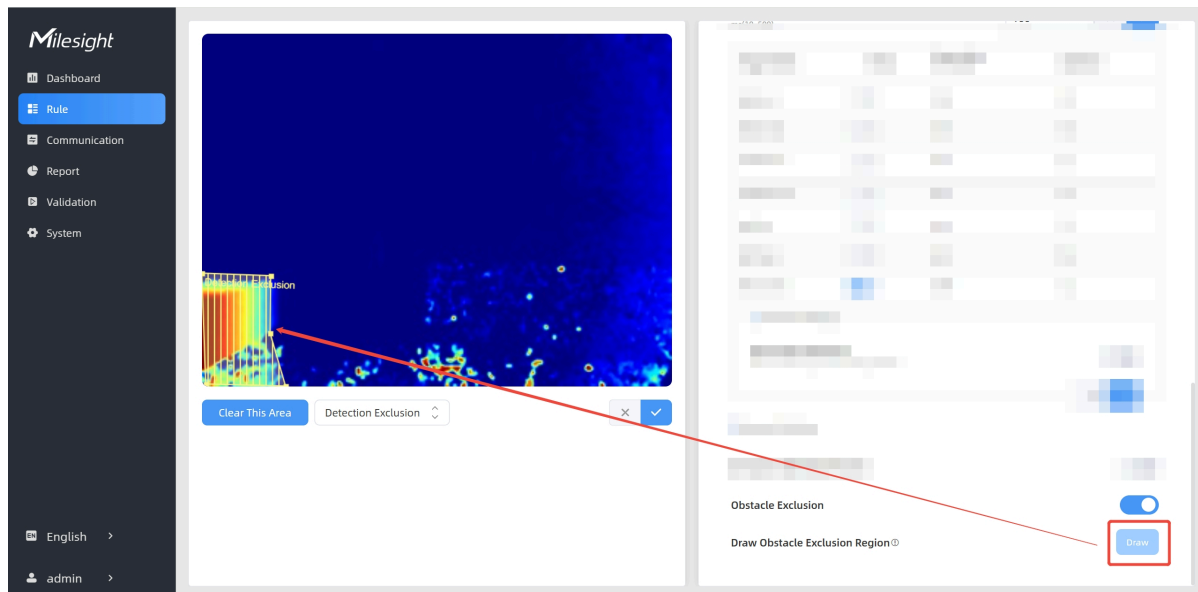

The region can be dragged to adjust the location and length.

One device supports up to 4 regions with maximum 10 segments each.

**Step 3:** Choose the method of exclusion.

**Detection Exclusion:** Select it when you don't want to detect anything in this area. You can just draw the highest part of the obstacle, the device will use this highest part as a reference to automatically exclude this specific area.

(For example, in a shelf scene, you can just frame the top end of the shelf, then the shelf won't be mistakenly detected as a person.)

**Height Exclusion:** Select it when you want to avoid mixing obstacles with targets and creating false detections. You can just box out the parts that are easy to confuse with the targets.

(For example, in the scene of a gate passage, you can draw the shape of the gate to avoid the device misjudging a child passing through as an adult, as the child may blend into the shape of the gate.)

**Step 4:** Click  to complete drawing.

**Step 5:** Users can see the effect in [Dashboard](#).

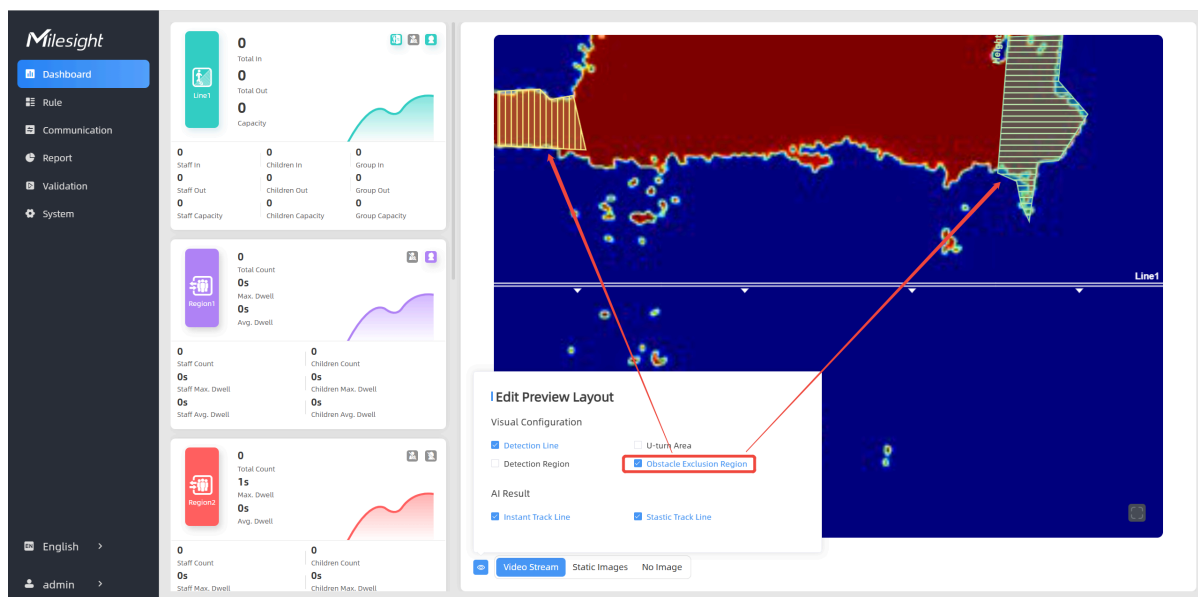

## Heat Map

Heat Map function analyzes personnel movement and displays intuitive and accurate statistical analysis results in different colors in a temporal or spatial pattern, as needed, to provide insights for better business management.

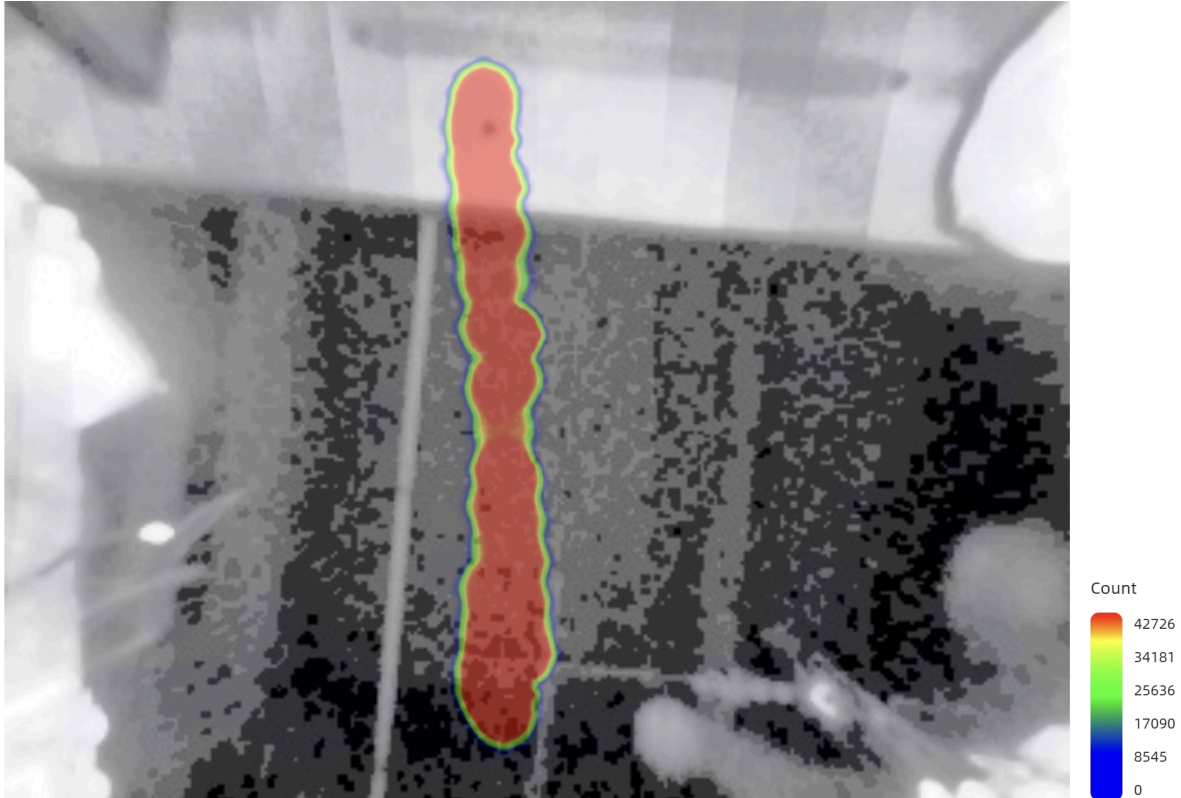

Support Motion Heat Map and Dwell Heat Map. The motion heat map shows where the most people flow. And the dwell heat map shows the areas where people stay for the longest time.

**Step 1:** Click to enable the **Heat Map** function, the device start to record.

**Step 2:** To view heat map's data for a certain time period and generate report, please refer to [Report](#).

Report type: 
 Time Range:

## Multi-Device Stitching

### Overview

Multi-device stitching is mainly used to monitor a larger detection area than just the area covered by a single device. When using this feature, devices should be installed next to each other and ensure the detection areas are tangent or overlapping.

**Note:**

1. Ensure the head of one person can be seen on both live views at the same time.

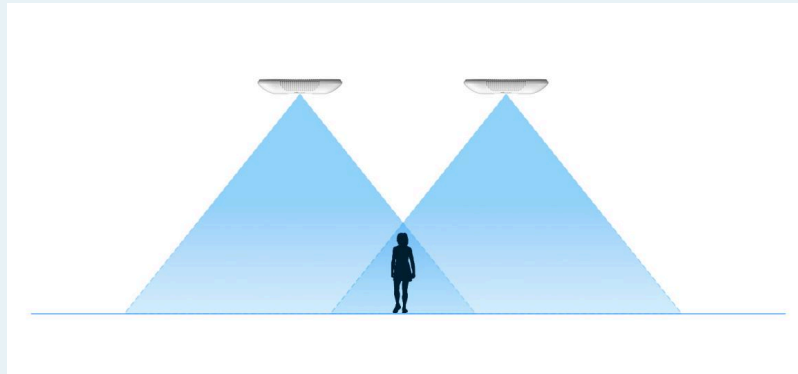

2. The devices can also be installed without overlapping.

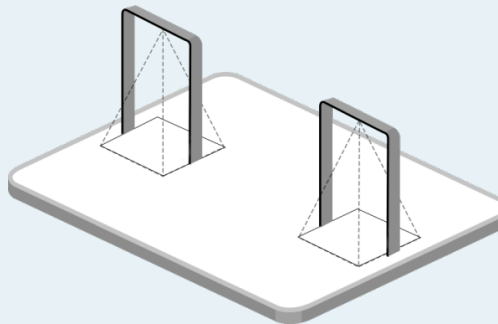

3. Device positioning is done via X&Y coordinates. For example, the installation direction of the master device is shown as below, the logo needs to be facing the front. When the master device's coordinate is (0, 0), the coordinates of the node devices are all positive values.

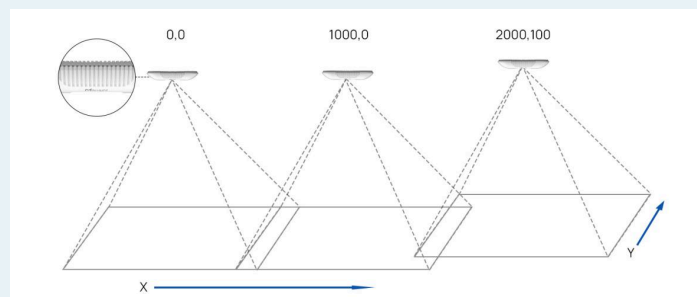

Before using this feature, set one device as **Master Mode** and other devices as **Node Mode**.

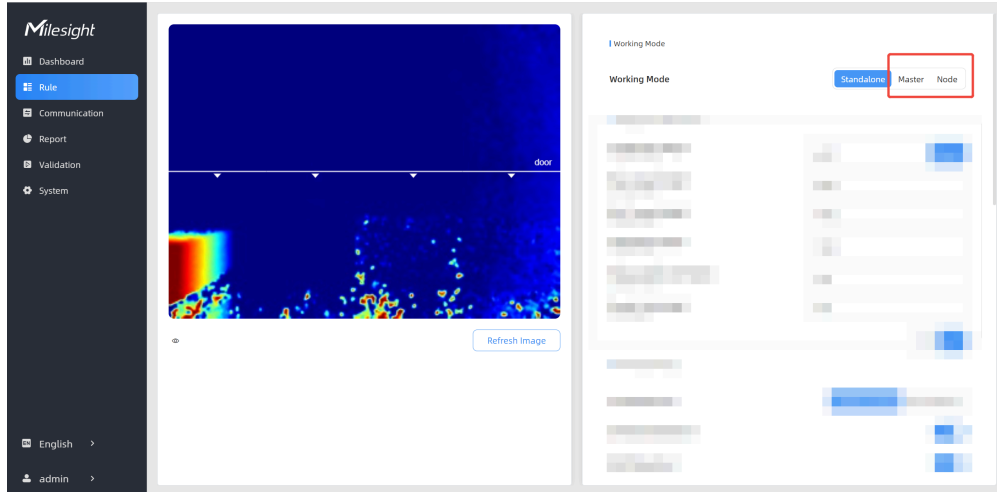

- Master Mode: Receive target tracks and view from the device, responsible for all counts, rule setting, data push and other functions.
- Node Mode: Only extends the view of the master device.

### Multi-Stitching Compatible List

Here is the device multi-stitching compatible list of VS13x series:

Stitching	Master Device	Node Devices	Stitching Number
Support	VS135-P	VS135-P	8
	VS135-P-High	VS135-P-High	
	VS135-L08EU	VS135-P, VS135-HL, VS135-LoRa, VS135-L08EU	4
	VS135-L08EU-High	VS135-P-High, VS135-HL-High, VS135-LoRa-High, VS135-L08EU-High	
	VS135-HL	VS135-P,	

Stitching	Master Device	Node Devices	Stitching Number
		VS135-L08EU, VS135-LoRa, VS135-HL	
	VS135-HL-High	VS135-P-High, VS135-L08EU-High, VS135-LoRa-High, VS135-HL-High	
	VS135-LoRa	VS135-P, VS135-L08EU, VS135-HL, VS135-LoRa	
	VS135-LoRa-High	VS135-P-High, VS135-L08EU-High, VS135-HL-High, VS135-LoRa-High	
Not Support	VS135-P	VS135-LoRa, VS135-L08EU, VS135-HL	/
	VS135-P-High	VS135-LoRa-High, VS135-L08EU-High, VS135-HL-High	

Stitching	Master Device	Node Devices	Stitching Number
	VS135 standard versions	VS135 high ceiling mount versions	
	VS135 high ceiling mount versions	VS135 standard versions	
	VS133-P	VS135-P	
	VS135-P	VS133-P	

### Node Device Setting

**Step 1:** change the WLAN IP Address of node devices to different subnets from master device's WLAN IP address.

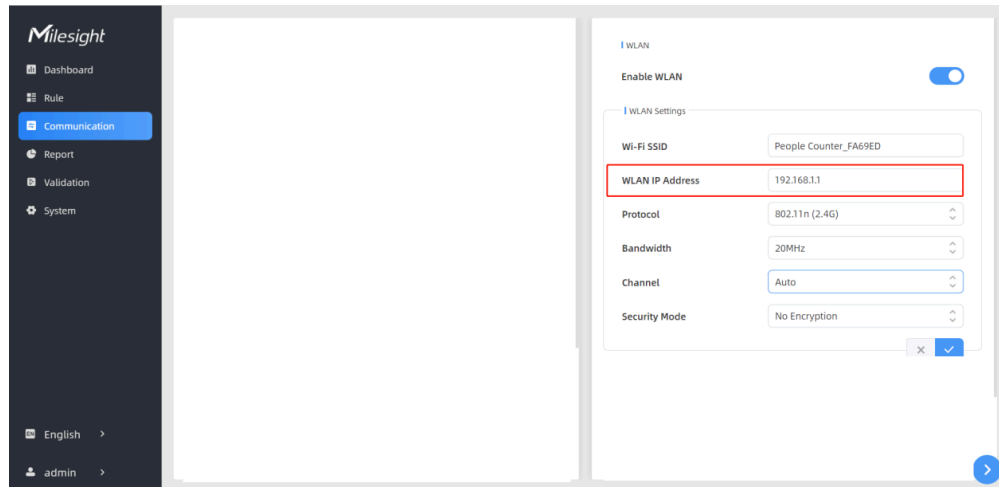

**Step 2:** Select work mode as Node and wait for the device to reboot.

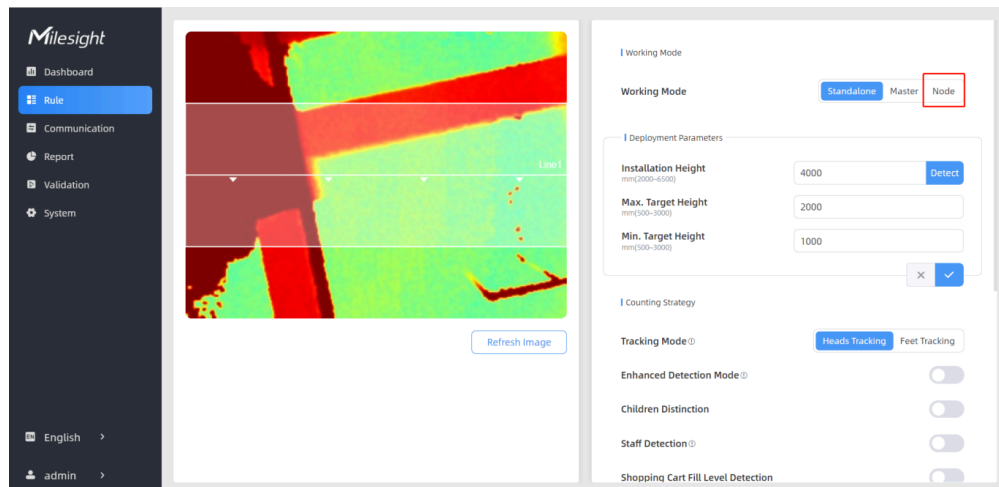

**Step 3:** Find the Wi-Fi access point of master device and connect.

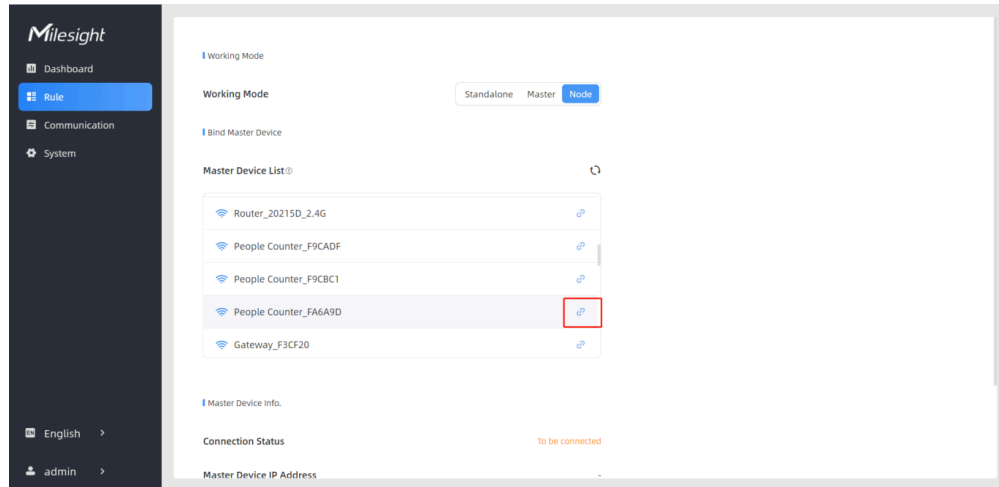

Parameters	Description
Connection Status	Show the connection status between the node device and master device.
Master Device IP Address	Show master device's IP address. When this IP address is under the same network with the node device, the node device can be bind to the master device.
Master Device SN	Show the master device's serial number.
Master Device Name	Show master device name.
Unbind Master Device	Click <b>Unbind</b> to release the connection status, this device will be deleted from the list of the master device.

## Master Device Setting

**Step 1:** When work mode is on Standalone or Node mode, select the WLAN channel to an idle channel. Users can use test App (like Wi-Fi Analyzer) to check ideal WLAN channels to reduce interference.

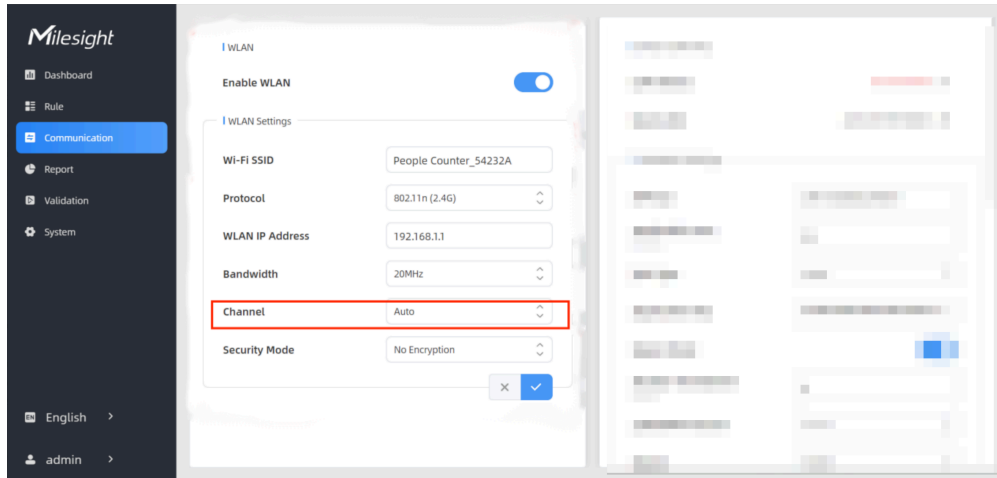

**Note:**

The scene preview and people counting results are dependent on the WLAN channel selection, also the distance between node devices and master device. Please adjust the distance to ensure accurate scene preview or counting results.

WLAN Channel	Video Stream	Static Image/ No Image	Counting Inaccuracy
Occupied Channel	Not Support	≤ 6.5m	> 6.5m
Idle Channel	≤8m	≤10m	>10m

**Step 2:** Select **Master** as the working mode and wait for the device to reboot.

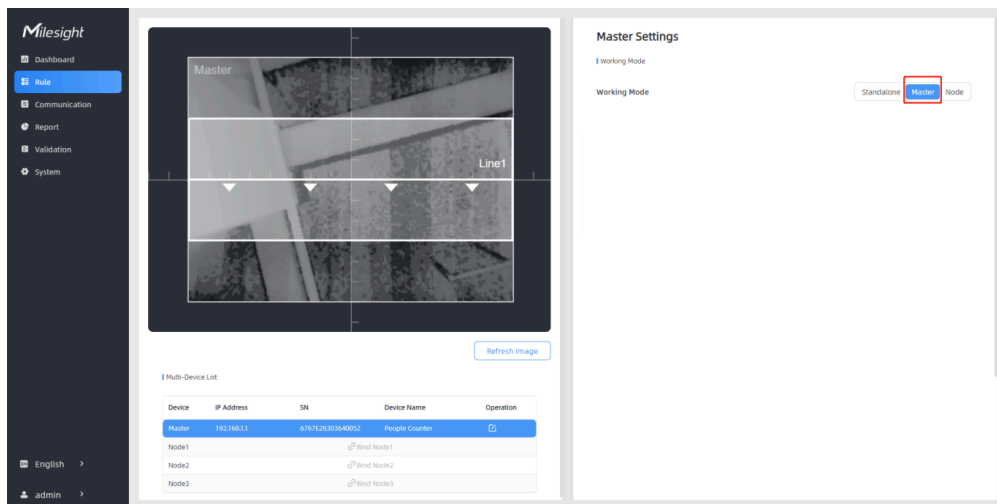

**Step 3:** Go to the master device web GUI, then click Bind Node in the Multi-Device List. The device will use multicast protocol to search for the unbound node devices under the same local network.

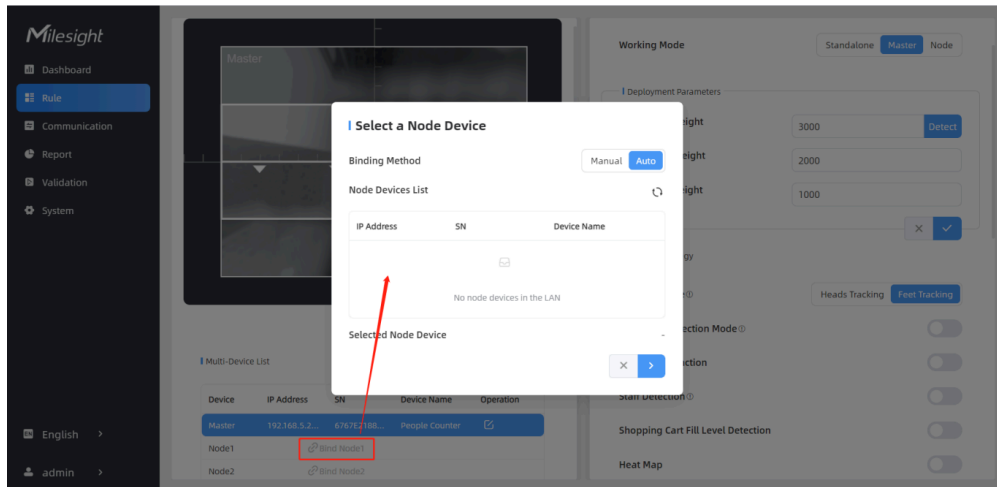

**Step 4:** Select the node device and type the login password of the node device.

**Step 5:** Fill in the installation height of a node device and relative position information if these parameters are already measured. If not, save default settings and skip to Step 6.

<p><b>Confirm Authorization</b></p> <p>Selected Node Device: 192.168.46.80</p> <p>Node Device Username: <input type="text" value="admin"/></p> <p>Node Device Password: <input type="password" value="••••••"/></p> <p style="text-align: right;"> <input type="button" value="X"/> <input type="button" value="←"/> <input type="button" value="→"/> </p>	<p><b>Bind the Node Device</b></p> <p>Selected Node Device: 192.168.46.80</p> <p>Installation Height: <input type="text" value="3000"/> <input type="button" value="Detect"/></p> <p>Relative X Position: <input type="text" value="1495"/></p> <p>Relative Y Position: <input type="text" value="0"/></p> <p>Relative Angle: <input type="text" value="0"/></p> <p style="text-align: right;"> <input type="button" value="X"/> <input type="button" value="←"/> <input type="button" value="✓"/> </p>
--	---

**Step 6:** Select the node device on the Multi-Device List, click **Adjust Relative Position**.

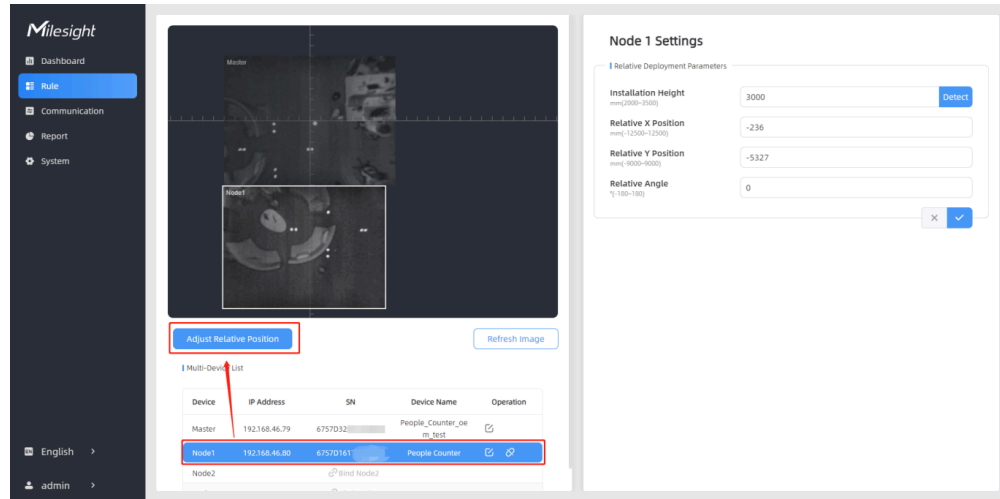

Drag the live view of node device to adjust the location and angle, and the relative position parameters will change automatically as your operations. Besides, users can also adjust the size of this live view.

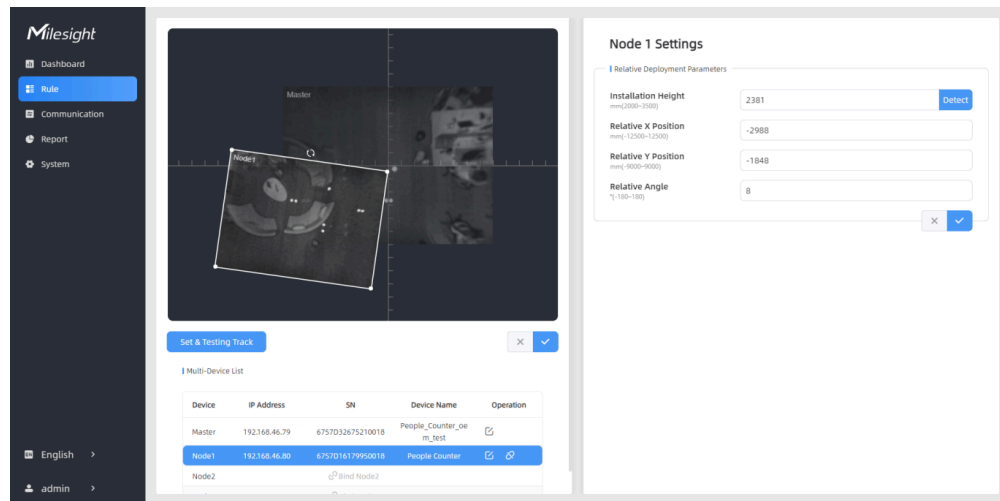

**Tip:**

Cut the staff tags or other reflective stripes into pieces and stick them to the ground of overlapping areas, then drag the live view of node devices to make highlight markers in the two live views overlap. This allows equipment splicing configuration without measurement.

**Step 7:** Click **Set & Testing Track**, then check if the tracking lines are connected and smooth when people pass on the live views of multiple devices. If not, click **Stop Testing** to adjust the node device's live view location slightly.

Device	IP Address	SN	Device Name	Operation
Master	192.168.46.79	6757D326	People_Counter_oe_m_test	
Node1	192.168.46.80	6757D161	People Counter	
Node2	192.168.46.83	6757D164	People Counter	
Node3	192.168.46.90	6757D161	People Counter	

**Step 8:** When all settings are completed, users can draw detection lines and even U-turn areas on the new stitching live view the same as standalone mode devices.

**Step 9:** Click Unbind to disconnect the node device if necessary.



Device	IP Address	SN	Device Name	Operation
Master	192.168.46.79	6757D326	People_Counter_oe_m_test	
Node1	192.168.46.80	6757D161	People Counter	
Node2	192.168.46.83	6757D164	People Counter	
Node3	192.168.46.90	6757D161	People Counter	

## Data Presentation

After completing the configuration of both the basic counting and advanced property, the device will offer multiple data presentation options, including dashboards, reports, command line outputs, etc. You can choose the appropriate method to view the data according to your needs.

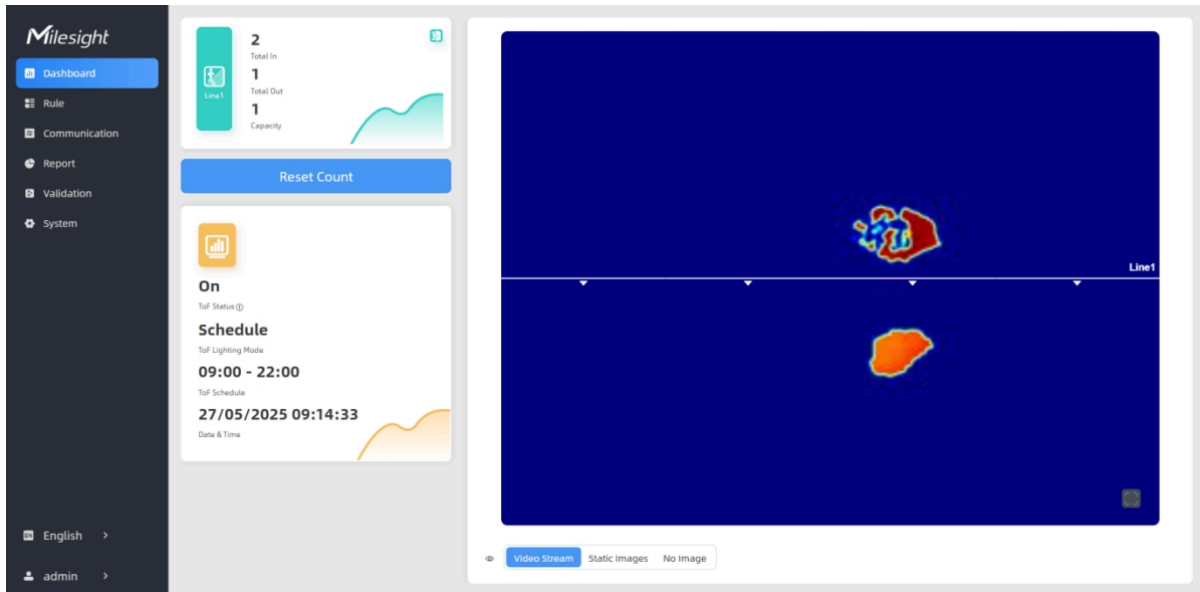
## Dashboard





Parameters	Description
	<p>Hide Capacity: Hide the total count data capacity;</p> <p><b>Children Excluded:</b> Exclude children data from statistical data.</p> <p><b>Staff Excluded:</b> Exclude staff data from statistical data.</p>
<p>Reset Count</p>	<p>Clear all accumulated entrance and exit people counting values.</p>
	<p>Click to edit preview layout to show or hide the lines, areas and track points as needed.</p> <p><b>Instant Track Line:</b> Show or hide the target's track line through the live view.</p> <p><b>Static Track Line:</b> Show or hide the history of the target's track line in the live view. Supports up to 1000 historical tracks, which will disappear when you refresh the page.</p>

Parameters	Description
	<p>Visual Configuration</p> <p><input checked="" type="checkbox"/> Detection Line <span style="margin-left: 200px;"><input checked="" type="checkbox"/> U-turn Area</span></p> <p><input checked="" type="checkbox"/> Detection Region <span style="margin-left: 150px;"><input checked="" type="checkbox"/> Obstacle Exclusion Region</span></p> <p>AI Result</p> <p><input checked="" type="checkbox"/> Instant Track Line <span style="margin-left: 150px;"><input type="checkbox"/> Stastic Track Line</span></p> <p>Other</p> <p><input type="checkbox"/> Track Start <span style="color: green;">●</span> / Stop <span style="color: red;">●</span> Points</p> <div style="background-color: #e0f2f1; padding: 10px; border-radius: 5px; margin-top: 10px;"> <p> <b>Note:</b> If some of the options are not shown, please check if the corresponding function of the rule is enabled.</p> </div>
Scene Preview	Select video stream preview, static image preview or no image preview as needed.

## Report

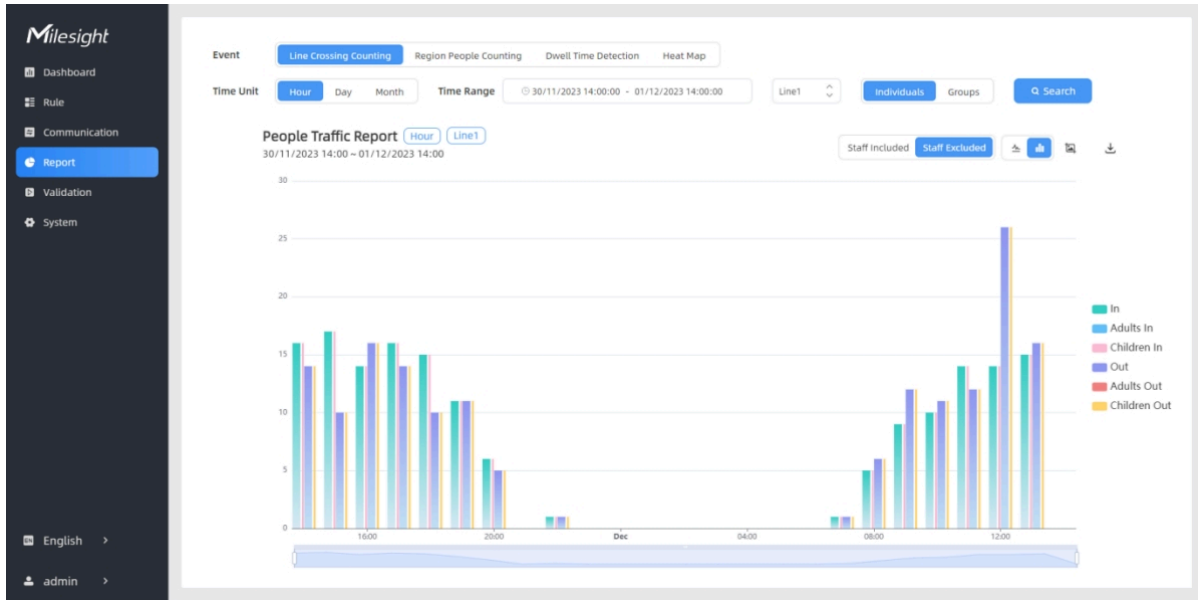
The device supports visual line chart or bar chart generation to display people traffic and supports report exporting. Before using this feature, do ensure that the device time is correct on **System** page.

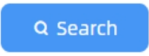
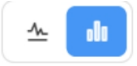
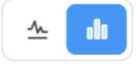

Parameters	Description
Event	Select the event which you want to query the report. Line crossing counting, region people counting, dwell time detection and heat map are optional.  When "regional people counting" is selected, it may take up to 30 seconds to retrieve data from a long time period, with a maximum of 20,000 records available at once.
Time Unit	Select the unit to generate the graph or export the data.
Time Range	Select the time range to generate the graph.
Report Type	For heat map report, Motion Heatmap and Dwell Heatmap are optional.
	Click to generate or refresh the graph according to the previously selected option.
Staff Included 	Select whether to include staff counting values on the graph.
	Select the display type as line or bar.
	Click to download the chart screenshot.

Parameters	Description
	Export the historical traffic data as CSV file according to the selected option. The device can store up to one million data records to CSV file.
<ul style="list-style-type: none"> <li><span style="display: inline-block; width: 10px; height: 10px; background-color: #27ae60; margin-right: 5px;"></span> In</li> <li><span style="display: inline-block; width: 10px; height: 10px; background-color: #3498db; margin-right: 5px;"></span> Adults In</li> <li><span style="display: inline-block; width: 10px; height: 10px; background-color: #e91e63; margin-right: 5px;"></span> Children In</li> <li><span style="display: inline-block; width: 10px; height: 10px; background-color: #34495e; margin-right: 5px;"></span> Out</li> <li><span style="display: inline-block; width: 10px; height: 10px; background-color: #e74c3c; margin-right: 5px;"></span> Adults Out</li> <li><span style="display: inline-block; width: 10px; height: 10px; background-color: #f1c40f; margin-right: 5px;"></span> Children Out</li> </ul>	The chart displays multiple data types. Click on any category will hide it from the chart.

## Communication

### WLAN

The device supports wlan feature to work as AP mode to configure device and it can not connect to other access point.

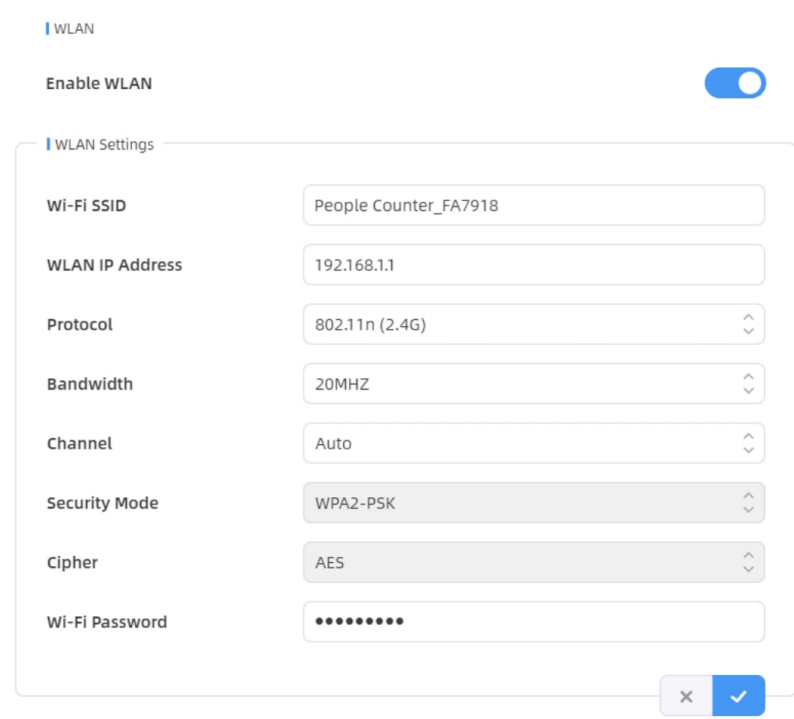

Parameters	Description
Enable WLAN	Enable or disable Wi-Fi feature. If disabled, users can use button to enable it.

Parameters	Description
Wi-Fi SSID	The unique name for this device Wi-Fi access point, defined as People Counter_xxxxxx (can be found on the device label).
WLAN IP Address	Configure WLAN IP address for web access, the default IP address is 192.168.1.1.
Protocol	802.11g (2.4 GHz) and 802.11n (2.4 GHz) are optional.
Bandwidth	20 MHz or 40 MHz are optional.
Channel	Select the wireless channel. Auto, 1,...11 are optional.
Security Mode	Fixed is WPA2-PSK.
Cipher	Fixed is AES.
Wi-Fi Password	Customize the password, 8-63 characters, including numbers, lowercase letters, uppercase letters and special characters.

## LoRa

LoRa settings are used for configuring the transmission parameters in LoRaWAN<sup>®</sup> network.

Device LoRa Info.

LoRa Status Activated

Device EUI 24E124757E033128

---

LoRaWAN® Settings

APP EUI

Application Port (1-223)

Join Type

Application Key

Rejoin Mode

Number of Detection (4-32)

LoRaWAN® Version

Region

RX2 Data Rate



RX2 Frequency MHz(915-928)

Spreading Factor

TXPower

Channel List

Parameters	Description
LoRa Status	LoRaWAN <sup>®</sup> network joining status of this device.
Device EUI	Unique ID of the device which can be found on the device. <div style="background-color: #e1f5fe; padding: 10px; border-radius: 5px; margin-top: 10px;"> <b>Note:</b>                          please contact sales for device EUI list if you have many units.                     </div>
App EUI	The default App EUI (join EUI) is 24E124C0002A0001.
Application Port	The port used for sending and receiving data, the default port is 85.
Join Type	OTAA and ABP mode are available. <div style="background-color: #e1f5fe; padding: 10px; border-radius: 5px; margin-top: 10px;"> <b>Note:</b>                          it's necessary to select OTAA mode if connecting device to Mile-sight IoT Cloud or Milesight Development Platform.                     </div>

Parameters	Description
Application Key	<p>Appkey for OTAA mode, default value: "Device EUI" + "Device EUI" (since Q4 of 2025). Example: 24e124123456789024e1241234567890</p> <div data-bbox="537 386 1417 722" style="background-color: #e6f2ff; padding: 10px; border-radius: 5px;"> <p> <b>Note:</b></p> <ul style="list-style-type: none"> <li>The default value of earlier devices is 5572404C696E6B4C6F52613230313823.</li> <li>Please contact sales before purchase if you require random App Keys.</li> </ul> </div>
Device Address	DevAddr for ABP mode, default is the 5 <sup>th</sup> to 12 <sup>th</sup> digits of SN.
Network Session Key	Nwkskey for ABP mode, the default is 5572404C696E6B4C6F52613230313823.
Application Session Key	Appskey for ABP mode, the default is 5572404C696E6B4C6F52613230313823.
Rejoin Mode	<p>Reporting interval ≤ 35 mins: the device will send a specific number of Link-CheckReq MAC packets to the network server every reporting interval or every double reporting interval to validate connectivity; If there is no response, the device will re-join the network.</p> <p>Reporting interval &gt; 35 mins: the device will send a specific number of Link-CheckReq MAC packets to the network server every reporting interval to validate connectivity; If there is no response, the device will re-join the network.</p> <div data-bbox="537 1493 1417 1780" style="background-color: #e6f2ff; padding: 10px; border-radius: 5px;"> <p> <b>Note:</b></p> <ol style="list-style-type: none"> <li>1. Only OTAA mode supports rejoin mode.</li> <li>2. The actual sending number is <b>Set the number of packets sent +1</b>.</li> </ol> </div>
Number of Detection	When rejoin mode is enabled, set the number of detection.

Parameters	Description
	 <b>Note:</b> the actual sending number is <b>Number of Detection + 1</b> .
LoRaWAN <sup>®</sup> Version	V1.0.2 and V1.0.3 are available.
Region	Frequency plan of this device.
RX2 Data Rate	RX2 data rate to receive downlinks.
RX2 Frequency	RX2 frequency to receive downlinks. Unit: MHz
Spreading Factor	If ADR mode is disabled, the device will send uplink data following this SF parameter. The higher the spreading factor, the longer the transmission distance, the slower the transmission speed and the more the consumption.
Tx Power	Tx power (transmit power) refers to the strength of the outgoing signal transmitted by the device. This is defined by LoRa alliance.
Channel List	Select the channel from channel list or enter the index to select the frequency channel.  <b>Index examples:</b>  1, 40: Enabling Channel 1 and Channel 40  1-40: Enabling Channel 1 to Channel 40  1-40, 60: Enabling Channel 1 to Channel 40 and Channel 60  All: Enabling all channels  Null: Indicates that all channels are disabled
Confirmed Mode	If the device does not receive ACK packet from network server, it will re-send data once.
ADR	Enable or disable network server to adjust Spreading Factor, Bandwidth and TX Power to optimize data rates, airtime and energy consumption in the network.

# Validation

Video validation function can assist users in verifying the accuracy of people counting by setting up a video recording task.

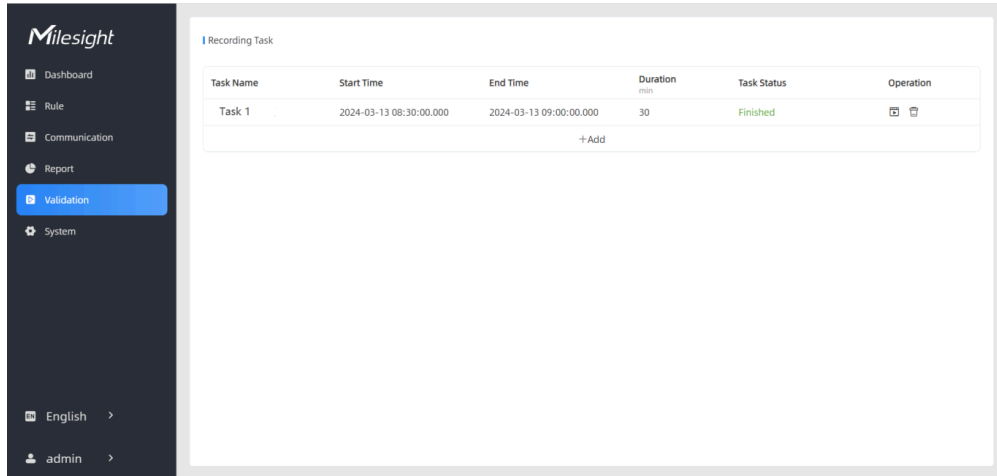

Parameters	Description
Task Name	Show the task name.
Start/End Time	Show the start time and end time of this video.
Duration	Show the length of the video.
Task Status	Show the video task status.
Operation	Click to check the video details, stop recording or delete the task.
+Add	Click to add a video task. One device can add up to 24 tasks.

### | Set a Task of Recording

**Task Name**

**Recording Mode**

**Start Time**

**Duration**   
min(1~60)



**Video Quality**

Parameters	Description
Task Name	Customize a name for this task.
Recording Mode	Record Now or Setting Time is optional.
Start Time	Set the start recording time.
Duration	Set the duration of the recording, the duration of all tasks should not be more than 240 minutes.
Video Quality	When video quality is low, the video size will be smaller and quicker to download.

**Note:**

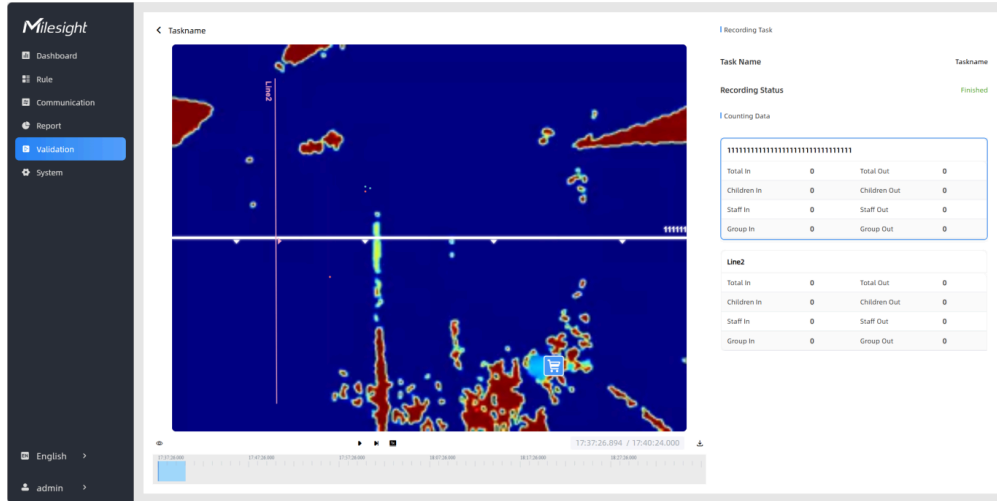
- The setting time range of different tasks can not be overlap.
- Detection rules and ToF frequency parameters cannot be modified during the recording process.
- If the validation videos need to be played locally, please use the specialized player provided by Milesight: [Milesight VS Player](#).



Parameters		Description
 Edit Pre-view Layout	Visual Configuration	Show/Hide relevant rule in the recording footage. <input type="checkbox"/> Detection Line <input checked="" type="checkbox"/> U-turn Area <input checked="" type="checkbox"/> Detection Region <input checked="" type="checkbox"/> Obstacle Exclusion Region
	AI Result	Show/Hide track line in the recording footage. <b>Real-time Track Line:</b> real-time trajectory line of the targets <b>Static Track Line:</b> historical trajectory line of the targets
	Other	Show/Hide track points in the recording footage.
Playback Button		Rewind/Pause/Play/Forward(supports switching between 0.5x, 1x, 2x, and 4x playback speed).
	15:20:50.035 / 15:21:04.000	Start time and end time of the recording.
		Download video stream footage to check problem.



**Note:**

The playback progress bar of video stream footage highlights the video frame where the data changes.

# System

## Device Info

All information about the hardware and software can be checked on this page.

**Device Info.**

<b>Device Name</b>	<input type="text" value="People Counter"/>
<b>Product Model</b>	<input type="text" value="VS135-868M"/>
<b>SN</b>	<input type="text" value="6767D51165730004"/>
<b>Hardware Version</b>	<input type="text" value="V1.2"/>
<b>Software Version</b>	<input type="text" value="V_135.1.0.5-r1-b"/>
<b>WLAN MAC Address</b>	<input type="text" value="24:E1:24:36:37:38"/>

x
✓

## User

**Users**

Username	User Level	Operation
admin	Administrator	
+ Add User		

Parameters	Description
	You can change the login password of this device.

Parameters	Description
	<div data-bbox="592 268 1187 831"><h3>Users modify</h3><p><b>Username</b> <input type="text" value="admin"/></p><p><b>User Level</b> <input type="text" value="Administrator"/></p><p><b>Administrator Password</b> <input type="text"/></p><p><b>New Password</b> <input type="text"/></p><p><b>Confirm</b> <input type="text"/></p><p><b>At least:</b></p><ul style="list-style-type: none"><li>• 8 characters</li><li>• 2 types of characters: Number, letter and symbol</li></ul><p><input type="button" value="x"/> <input type="button" value="✓"/></p></div>
	<p>Click to set three security questions for your device. In case that you forget the password, you can click <b>Forget Password</b> button on login page to reset the password by answering three security questions correctly.</p> <div data-bbox="592 1077 1187 1661"><h3>Secure Question Settings <span>Already Set</span></h3><p><b>Password</b> <input type="text"/></p><p><b>Security Question1</b> <input type="text" value="What is your lucky number?"/></p><p><b>Answer1</b> <input type="text"/></p><p><b>Security Question2</b> <input type="text" value="What is your favorite sport?"/></p><p><b>Answer2</b> <input type="text"/></p><p><b>Security Question3</b> <input type="text" value="What is your favorite game?"/></p><p><b>Answer3</b> <input type="text"/></p><p><input type="button" value="x"/> <input type="button" value="✓"/></p></div>
<p>+ Add User</p>	<p>Click to add a viewer, who will only have access to the "Dashboard" and "Report" interfaces.</p>

Parameters	Description
	<div style="border: 1px solid #ccc; padding: 10px;"> <p><b>Add User</b></p> <p><b>Username</b> <input type="text" value="viewer"/></p> <p><b>User Level</b> <input type="text" value="Viewer"/></p> <p><b>Password</b> <input type="password"/></p> <p><b>Confirm</b> <input type="password"/></p> <p><b>At least:</b></p> <ul style="list-style-type: none"> <li>• 8 characters</li> <li>• 2 types of characters: Number, letter and symbol</li> </ul> <p style="text-align: right;"><input type="button" value="X"/> <input style="background-color: #007bff; color: white;" type="button" value="✓"/></p> </div>

## Time Configuration

**Current System Time**

**Date** 10/02/2025

**Time** 11:18:09

---

**Set the System Time**

**Time Zone**

**Daylight Saving Time**

---

**Synchronize Time**

**Synchronize Mode**

**Time Interval**  min(1-10080)

Parameters	Description
Time Zone	Choose the time zone for your location.

Parameters	Description
Daylight Saving Time	<p>Enable or disable Daylight Saving Time (DST).</p> <p><b>Start Time:</b> the start time of DST time range.</p> <p><b>End Time:</b>the end time of DST time range.</p> <p><b>DST Bias:</b> the DST time will be faster according to this bias setting.</p>
Synchronize Mode	<p>Synchronize the time. Gateway Timing or Manual Timing is optional.</p> <p>Gateway Timing: Synchronize the system time with embedded network server of Milesight gateway when LoRaWAN<sup>®</sup> version is 1.0.3.</p> <p><b>Time Interval:</b> Set the interval to sync time with gateway.</p> <p>Manual Timing: Manual time synchronization.</p> <p><b>Setting Time:</b> Set the device time manually.</p> <p><b>Synchronize with your computer time:</b> Click to manually synchronize of computer time.</p>

## System Maintenance

### Time of Flight Advanced Settings

Frequency Adjustment Modulation Mode A

ToF Lighting Mode Always On Schedule

Schedule Settings 09:00 - 22:00 X ✓

ToF Noise Filtering

Noise Filtering Level

### Reset

Recovery device basic configuration Basic Recovery

Recovery device to factory settings All Recovery

### Reboot

Reboot the Device Reboot

Parameters	Description
Frequency Adjustment	<p>Adjust the ToF frequency modulation mode to avoid the interference of surrounding IR devices. Please avoid using the same mode if there are multiple VS135 devices around.</p> <div style="background-color: #e6f2ff; padding: 10px; border-radius: 5px;"> <p> <b>Note:</b> if there is only one option, please contact Milesight IoT support: <a href="mailto:iot.support@milesight.com">iot.support@milesight.com</a></p> </div>
ToF Lighting Mode	<p>Adjust the ToF light mode as Always On or Schedule. When using Schedule mode, the device will only turn on the ToF light during scheduled time range to save power.</p>

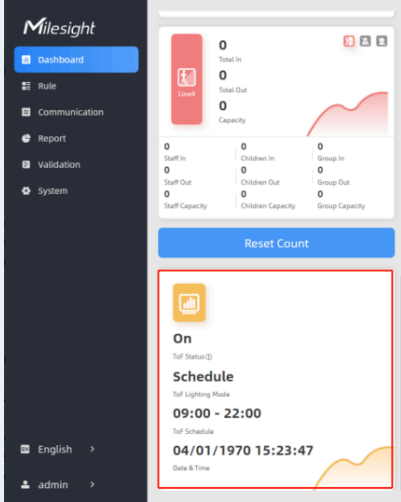
Parameters	Description
	<p> <b>Note:</b></p> <ol style="list-style-type: none"> <li>1. ToF light off will not affect the periodic report.</li> <li>2. During validation, the ToF lighting will be fixed as On regardless of its lighting mode configuration.</li> <li>3. When using ToF Lighting Mode, the Dashboard will display relevant information.</li> </ol> 
ToF Noise Filtering	Filter the noisy point on the screen when working with dark floor or carpet.
Noise Filtering Level	Set the appropriate noise filtering level according to the actual image. The more difficult it is to see the target, the higher the filter value should be set.
Tilt Correction	Enable to automatic compensation of person height values when the device is mounted at a tilt.
LED Indicator switch	Enable or disable LED indicator when device is in normal operation.
Reset	<b>Recovery device basic configuration:</b> keep the IP settings and user information when resetting.

Parameters	Description
	<b>Recovery device to factory settings:</b> reset device to factory default, which needs to verify admin password.
Reboot	Restart the device immediately.
Upgrade	<p>Click the folder icon and select the upgrading file, then click the <b>Upgrade</b> button to upgrade. The update will be done when the system reboots successfully.</p> <div data-bbox="553 642 1417 821" style="background-color: #e6f2ff; padding: 10px; border: 1px solid #add8e6;"> <p> <b>Note:</b> The upgrade process takes about 1-10 minutes. Do not turn off the power and complete automatic restart after the upgrade.</p> </div>
Backup and Restore	<b>Export Config File:</b> Export configuration file.
	<b>Import Config File:</b> Click the file icon and select the configuration file, click <b>Import</b> button to import configuration file.
Diagnostics	<b>System Log:</b> Download log files that can be used for troubleshooting.
	<p><b>Log Mode - File:</b> Select the desired level of the download log files for troubleshooting. Recommendation level to Fatal, Error and Warn.</p> <p>Fatal: recording device crashes or unrecoverable critical events</p> <p>Error: recording errors that is abnormal for a critical function</p> <p>Warn: recording events that may cause problems</p> <p>Debug: recording detailed internal operational and status information</p> <p>Trace: recording all events</p>

# Chapter 8. Communication Protocol

## Overview

All messages are based on following format (HEX), the Data field should follow little-endian:

Channel1	Type1	Data1	Channel2	Type2	Data2	Channel3	...
1 Byte	1 Byte	N Bytes	1 Byte	1 Byte	N Bytes	1 Byte	...

For decoder examples please find files on <https://github.com/Milesight-IoT/SensorDecoders>.

## Uplink Data

The device reports basic information of sensor whenever joining the network and the number of people periodically.

### Basic Information

The device will report a basic information packet whenever joining the network.

Item	Channel	Type	Byte	Description
Protocol Version	ff	01	1	Example: 01=V1
Hardware Version	ff	09	2	Example: 03 10 = V3.1
Serial Number	ff	16	8	16 digits
Software Version	ff	1f	4	Example: 85 01 00 05 => 133.1.0.5

**Example:**

ff0101 ff166600b09409760000 ff090102 ff1f85010001		
Channel	Type	Value
ff	01	01 (V1)
ff	16	66 00 b0 94 09 76 00 00
ff	09	0102 (V1.2)
ff	1f	85 01 00 01 (V135.1.0.1)

## Periodic Report

The device supports to report below types of periodic report packets.

Item	Channel	Type	Byte	Description
Accumulat- ed counter	03	d2	4	Line 1 accumulated <b>in</b> counter
	04	d2	4	Line 1 accumulated <b>out</b> counter
	06	d2	4	Line 2 accumulated <b>in</b> counter
	07	d2	4	Line 2 accumulated <b>out</b> counter
	09	d2	4	Line 3 accumulated <b>in</b> counter
	0a	d2	4	Line 3 accumulated <b>out</b> counter
	0c	d2	4	Line 4 accumulated <b>in</b> counter
	0d	d2	4	Line 4 accumulated <b>out</b> counter
Children accu- mulated counter	11	d2	4	Line 1 accumulated <b>in</b> counter about children
	12	d2	4	Line 1 accumulated <b>out</b> counter about children
	14	d2	4	Line 2 accumulated <b>in</b> counter about children
	15	d2	4	Line 2 accumulated <b>out</b> counter about children
	17	d2	4	Line 3 accumulated <b>in</b> counter about children
	18	d2	4	Line 3 accumulated <b>out</b> counter about children
	1a	d2	4	Line 4 accumulated <b>in</b> counter about children
	1b	d2	4	Line 4 accumulated <b>out</b> counter about children
Region Monitoring	0f	e3	4	Byte 1: number of people in region 1 Byte 2: number of people in region 2 Byte 3: number of people in region 3 Byte 4: number of people in region 4
Children Re- gion Monitoring	1d	e3	4	Byte 1: number of children in region 1 Byte 2: number of children in region 2 Byte 3: number of children in region 3

Item	Channel	Type	Byte	Description
				Byte 4: number of children in region 4
Region Dwell Time	10	e4	5	Byte 1: region ID Byte 2-3: avg. dwell time Byte 4-5: max. dwell time
Children Re- gion Dwell Time	1e	e4	5	Byte 1: region ID Byte 2-3: avg. dwell time Byte 4-5: max. dwell time
Periodic counter	05	cc	4	<b>Line 1:</b> Byte 1-2: in counter during the report interval Byte 3-4: out counter during the report interval
	08	cc	4	<b>Line 2:</b> Byte 1-2: in counter during the report interval Byte 3-4: out counter during the report interval
	0b	cc	4	<b>Line 3:</b> Byte 1-2: in counter during the report interval Byte 3-4: out counter during the report interval
	0e	cc	4	<b>Line 4:</b> Byte 1-2: in counter during the report interval Byte 3-4: out counter during the report interval
Children Peri- odic counter	13	cc	4	<b>Line 1:</b> Byte 1-2: in counter during the report interval Byte 3-4: out counter during the report interval

Item	Channel	Type	Byte	Description
	16	cc	4	<b>Line 2:</b> Byte 1-2: in counter during the report interval Byte 3-4: out counter during the report interval
	19	cc	4	<b>Line 3:</b> Byte 1-2: in counter during the report interval Byte 3-4: out counter during the report interval
	1c	cc	4	<b>Line 4:</b> Byte 1-2: in counter during the report interval Byte 3-4: out counter during the report interval



**Note:**

- If children distinction feature or staff detection feature is enabled, the counter uplinks will minus children and staff. For example, if children distinction is enabled, the accumulated in counter=total in counter-children in, the accumulated out counter=total out counter-children out.
- If group counting is enabled, the Accumulated counter and Periodic counter are replaced by the accumulated group counter and periodic group counter.

**Example:**

1. Period Report. (Disable Children Distinction)

03d205000000 04d203000000 11d245030000 12d2cb010000 06d249050000 07d246030000 14d246030000 15d2c9010000 09d200000000 0ad200000000 17d200000000 18d200000000 0cd200000000 0dd200000000 1ad200000000 1bd200000000 0fe300000000 1de300000000 10e4012a005a00		
Channel	Type	Value
03	d2	Line 1 accumulated in counter: 05 00 00 00 => 00 00 00 05=5
04	d2	Line 1 accumulated out counter: 03 00 00 00 => 00 00 00 03=3
11	d2	Line 1 accumulated in counter about chil- dren: 45 03 00 00=>00 00 03 45=837
12	d2	Line 1 accumulated out counter about children: cb010000=>000001cb=459
06	d2	Line 2 accumulated in counter: 49 05 00 00=>00 00 05 49=1353
07	d2	Line 2 accumulated out counter: 46030000=>00000346=838
14	d2	Line 2 accumulated in counter about children: 46030000=>00000346=838
15	d2	Line 2 accumulated out counter about children: c9010000=>000001c9=457
09	d2	Line 3 accumulated in counter: 00000000=>0
0a	d2	Line 3 accumulated out counter: 00000000=>0
17	d2	Line 3 accumulated in counter about children: 00000000=>0
18	d2	Line 3 accumulated out counter about children: 00000000=>0
0c	d2	Line 4 accumulated in counter: 00000000=>0
0d	d2	Line 4 accumulated out counter: 00000000=>0

03d205000000 04d203000000 11d245030000 12d2cb010000 06d249050000 07d246030000 14d246030000 15d2c9010000 09d200000000 0ad200000000 17d200000000 18d200000000 0cd200000000 0dd200000000 1ad200000000 1bd200000000 0fe300000000 1de300000000 10e4012a005a00		
Channel	Type	Value
1a	d2	Line 4 accumulated in counter about children: 00000000=>0
1b	d2	Line 4 accumulated out counter about children: 00000000=>0
0f	e3	Region Monitoring: 00000000=>0
1d	e3	Children Region Monitoring: 00000000=>0
10	e4	Region Monitoring: 00000000=>0
1e	e4	Children Region Monitoring: 01=region 1 avg. dwell time: 2a00=>002a=42s max. dwell time: 5a00=>005a =90s

2. Period Report. (Enable Children Distinction)

13cc05000000 08cc03000000 16cc02000000 0bcc05000000 19cc03000000 0ecc04000000 1ccc05000000		
Channel	Type	Value
13	cc	05 00 00 00 => 00 00 00 05=5
08	cc	03 00 00 00 => 00 00 00 03=3
16	cc	02 00 00 00 => 00 00 00 05=2
0b	cc	05 00 00 00 => 00 00 00 05=5
19	cc	03 00 00 00 => 00 00 00 05=3
0e	cc	04 00 00 00 => 00 00 00 05=4
1c	cc	05 00 00 00 => 00 00 00 05=5

3. Period Report. (Enable Group Counting)

03d201000000 04d202000000 11d245030000 12d2cb010000 06d249050000 07d246030000 14d246030000 15d2c9010000 09d200000000 0ad200000000 17d200000000 18d200000000 0cd200000000 0dd200000000 1ad200000000 1bd200000000 0fe300000000 1de300000000 10e4012a005a00		
Channel	Type	Value
03	d2	Line 1 accumulated in <b>group</b> counter: 01 00 00 00 => 00 00 00 01=1
04	d2	Line 1 accumulated out <b>group</b> counter: 02 00 00 00 => 00 00 00 02=2
11	d2	Line 1 accumulated in counter about chil- dren: 45 03 00 00=>00 00 03 45=837
12	d2	Line 1 accumulated out counter about children: cb010000=>000001cb=459
06	d2	Line 2 accumulated in counter: 49 05 00 00=>00 00 05 49=1353
07	d2	Line 2 accumulated out counter: 46030000=>00000346=838
14	d2	Line 2 accumulated in counter about children: 46030000=>00000346=838
15	d2	Line 2 accumulated out counter about children: c9010000=>000001c9=457
09	d2	Line 3 accumulated in counter: 00000000=>0
0a	d2	Line 3 accumulated out counter: 00000000=>0
17	d2	Line 3 accumulated in counter about children: 00000000=>0
18	d2	Line 3 accumulated out counter about children: 00000000=>0
0c	d2	Line 4 accumulated in counter: 00000000=>0
0d	d2	Line 4 accumulated out counter: 00000000=>0

03d201000000 04d202000000 11d245030000 12d2cb010000 06d249050000 07d246030000 14d246030000 15d2c9010000 09d200000000 0ad200000000 17d200000000 18d200000000 0cd200000000 0dd200000000 1ad200000000 1bd200000000 0fe300000000 1de300000000 10e4012a005a00		
Channel	Type	Value
1a	d2	Line 4 accumulated in counter about children: 00000000=>0
1b	d2	Line 4 accumulated out counter about children: 00000000=>0
0f	e3	Region Monitoring: 00000000=>0
1d	e3	Children Region Monitoring: 00000000=>0
10	e4	Region Monitoring: 00000000=>0
1e	e4	Children Region Monitoring:  01=region 1  avg. dwell time: 2a00=>002a=42s  max. dwell time: 5a00=>005a =90s

### Trigger Report

Report immediately when something changes.

Item	Channel	Type	Byte	Description
Accumulat- ed counter	03	d2	4	Line 1 accumulated <b>in</b> counter
	04	d2	4	Line 1 accumulated <b>out</b> counter
	06	d2	4	Line 2 accumulated <b>in</b> counter
	07	d2	4	Line 2 accumulated <b>out</b> counter
	09	d2	4	Line 3 accumulated <b>in</b> counter
	0a	d2	4	Line 3 accumulated <b>out</b> counter
	0c	d2	4	Line 4 accumulated <b>in</b> counter
	0d	d2	4	Line 4 accumulated <b>out</b> counter

Item	Channel	Type	Byte	Description
Children accumulated counter	11	d2	4	Line 1 accumulated <b>in</b> counter about children
	12	d2	4	Line 1 accumulated <b>out</b> counter about children
	14	d2	4	Line 2 accumulated <b>in</b> counter about children
	15	d2	4	Line 2 accumulated <b>out</b> counter about children
	17	d2	4	Line 3 accumulated <b>in</b> counter about children
	18	d2	4	Line 3 accumulated <b>out</b> counter about children
	1a	d2	4	Line 4 accumulated <b>in</b> counter about children
	1b	d2	4	Line 4 accumulated <b>out</b> counter about children
Region Monitoring	0f	e3	4	Byte 1: number of people in region 1 Byte 2: number of people in region 2 Byte 3: number of people in region 3 Byte 4: number of people in region 4
Children Region Monitoring	1d	e3	4	Byte 1: number of children in region 1 Byte 2: number of children in region 2 Byte 3: number of children in region 3 Byte 4: number of children in region 4
Region Dwell Time	10	e4	5	Byte 1: region ID Byte 2-3: avg. dwell time Byte 4-5: max. dwell time
Children Region Dwell Time	1e	e4	5	Byte 1: region ID Byte 2-3: avg. dwell time Byte 4-5: max. dwell time

**Example:**

1. Report immediately when two adults have entered line 1.

03d2 02000000		
Channel	Type	Value
03	d2	Line 1 accumulated in counter: 02 00 00 00 => 00 00 00 02=2

2. Report immediately when 3 children are detected in region 2.

1de3 00020000		
Channel	Type	Value
1d	e3	The number of children in region 1: 00=>0  The number of children in region 2: 02=>2  The number of children in region 3: 00=>0  The number of children in region 4: 00=>0

### Alarm Report

The device supports to report below types of alarm report packets.

Item	Channel	Type	Byte	Description
Alarm	50	fc	3	Byte 1: 01: Occlusion Detection Alarm Byte 2: ID, 00: This Device, 01~0f: Node device Byte 3: 01: Alarm; 00: Release

**Example:**

Occlusion Detection Alarm.

50fc 010001		
Channel	Type	Value
50	fc	01 => Occlusion Detection Alarm

50fc 010001		
Channel	Type	Value
		00 => This Device
		01 => Alarm

### Historical Data

The device will report retransmission data or stored data as below example.

Channel	Type	Byte	Description
20	ce	8/9	Byte 1-4: Unix Timestamp, Unit:s Byte 5: Data Type. 03-Line 1 accumulated in counter 04-Line 1 accumulated out counter 06-Line 2 accumulated in counter 07-Line 2 accumulated out counter 09-Line 3 accumulated in counter 0a-Line 3 accumulated out counter 0c-Line 4 accumulated in counter 0d-Line 4 accumulated out counter 05-Line 1 Periodic counter 08-Line 2 Periodic counter 0b-Line 3 Periodic counter 0e-Line 4 Periodic counter 0f-Region people number 10-Region avg. dwell time

Channel	Type	Byte	Description
			20-Region max. dwell time  11-Line 1 Children accumulated in counter 12-Line 1 Children accumulated out counter 14-Line 2 Children accumulated in counter 15-Line 2 Children accumulated out counter 17-Line 3 Children accumulated in counter 18-Line 3 Children accumulated out counter 1a-Line 4 Children accumulated in counter 1b-Line 4 Children accumulated out counter 13-Line 1 Children Periodic counter 16-Line 2 Children Periodic counter 19-Line 3 Children Periodic counter 1c-Line 4 Children Periodic counter 1d-Children region people number 1e-Children region ID avg. dwell time 3c-Children region ID max. dwell time  Byte 6-N: history data.

## Downlink Command

The device supports to configure the device via downlink commands. Application port is 85 by default.

### General Setting

Item	Channel	Type	Byte	Description
Reboot	ff	10	1	ff

Item	Channel	Type	Byte	Description
System time	ff	11	4	Unix Timestamp, Unit:s
Wi-Fi	ff	42	1	00: disable, 01: enable
Clear the accumulated counting	ff	51	1	ff
Gateway time synchronization	f9	84	3	Byte 1: 01-Enable; 00-Disable Byte 2-3: Time Synchronization Interval, Unit: min
Log Mode - File	f9	89	2	Byte 1: 04 Byte 2: Log file level: 01-Fatal, 02-Error, 03-Warn, 04-Debug, 05-Trace

**Example:**

1. Reboot the device.

ff10ff
--------

2. Disable Wi-Fi.

ff42 00		
Channel	Type	Value
ff	42	00:Disable

3. Modify the system time as 2025/05/27 20:44:00.

ff11 90b33568		
Channel	Type	Value
ff	11	90 b3 35 68=>6835B390= 1748349840 s=>2025/05/27 20:44:00

## Report Setting

Item	Channel	Type	Byte	Description
People Counting Periodic Report	ff	43	1	00: disable, 01: enable
People Count- ing Trigger Report	ff	44	1	00: disable, 01: enable
Periodic Report Interval	ff	47	2	Unit: s
Periodic Report Scheme	f9	8a	1	01-From Now On, 00-On the Dot

### Example:

1. Set Periodic Report Interval as 20 minutes.

ff47 b004		
Channel	Type	Value
ff	47	b004=>04b0=1200s=20minutes

## Data Retransmission

Item	Channel	Type	Byte	Description
Data Retransmission	ff	69	1	00: Disable, 01: Enable
Data Retrans- mission Interval	ff	6a	3	<b>Byte 1:</b> 00 <b>Byte 2-3:</b> UINT16, Unit: s, Range: 30~1200, Default: 600

### Example:

1. Set the data retransmission interval as 1200s.

ff6ab004		
Channel	Type	Value
ff	6a	b004=>04b0=1200s

## LoRaWAN<sup>®</sup> Setting

Modifying the following parameters triggers the device to re-enter the network.

Item	Channel	Type	Byte	Description
Confirm Mode	ff	04	1	00: disable, 01: enable
LoRaWAN <sup>®</sup> Channel Mask	ff	05	3	Byte 1: Channel index range 01: 0-15 02: 16-31 03: 32-47 04: 48-63 05: 64-79 06: 80-95 Byte 2-3: indicate disable or enable via every bit, 0=disable, 1=enable
ADR	ff	40	1	00: disable, 01: enable
Application Port	ff	41	1	[1-223], Default is 85
LoRa Re-join Mode	f9	85	2	Byte 1: 01-Enable; 00-Disable Byte 2: The Number of Detection, Range: 4~32
Spreading Factor	f9	86	1	00-SF12, 01-SF11, 02-SF10, 03-SF9, 04-SF8, 05-SF7
TX Power	f9	87	1	Range: 0~14

### Example:

Set AU915 or US915 channel mask as 8-15.

ff0501ff00 ff05020000 ff05030000 ff05040000 ff05050000		
Channel	Type	Value
ff	05	01: Channel index 0-15, ff00 => 8-15 is enabled

ff0501ff00 ff05020000 ff05030000 ff05040000 ff05050000		
Channel	Type	Value
		02-05: Channel index 16-79, 0000 => all disabled

## Historical Data Enquiry

The device supports data retrievability feature to send downlink command to enquire the historical data stored in the device. Before that, ensure the device time is correct and data storage feature was enabled to store data.

### Command format

Item	Channel	Type	Byte	Description
Enquire Data in Time Point	fd	6b	4	Unix timestamp, Unit: s
Enquire Data in Time Range	fd	6c	8	Byte 1-4: Start timestamp, Unit: s Byte 5-8: End timestamp, Unit: s
Stop Query Data Report	fd	6d	1	ff
Data Retrieval Interval	ff	6a	3	Byte 1: 00 Byte 2-3: Interval time, unit: s, range: 30~1200s (60s by default)

### Reply format

Item	Channel	Type	Byte	Description
Enquiry Result	fc	6b/6c	1	00: Enquiry success. The device will report the historical data according to data retrievability interval. 01: Time point or time range invalid 02: No data in this time or time range



**Note:**

1. Use [Unix Timestamp Converter](#) to calculate the time.
2. The device only uploads no more than 300 data records per range enquiry.
3. When enquiring the data in time point, it will upload the data which is closest to the search point within the reporting interval range. For example, if the device's reporting interval is 10 minutes and users send command to search for 17:00's data, if the device find there is data stored in 17:00, it will upload this data; if not, it will search for data between 16:50 to 17:10 and upload the data which is closest to 17:00.

**Example:**

Enquire the historical data in a time range.

fd6c 64735b63 7c885b63		
Channel	Type	Value
fd	6c	Start time: 64 73 5b 63 => 63 5b 73 64 = 1666937700s End time: 7c 88 5b 63 => 63 5b 88 7c = 1666943100s

Reply:

fc6c00		
Channel	Type	Value
fc	6c	00: Enquiry success

20ce 4a7c5b63 0411000000			
Channel	Type	Time Stamp	Value
20	ce	4a 7c 5b 63=> 63 5b 7c 4a=1666939978 s = 2022-10-28 14:52:58	04 => Accumulated out counter Line1 Out: 11 00 00 00=> 00 00 00 11 = 17

## Chapter 9. Services

Milesight provides customers with timely and comprehensive technical support services. End-users can contact your local dealer to obtain technical support. Distributors and resellers can contact directly with Milesight for technical support.

Technical Support Mailbox: [iot.support@milesight.com](mailto:iot.support@milesight.com)

Online Support Portal: <https://support.milesight-iot.com>

Resource Download Center: <https://www.milesight.com/iot/resources/download-center/>

### **MILESIGHT CHINA**

TEL: +86-592-5085280

FAX: +86-592-5023065

Add: Building C09, Software Park Phase III, Xiamen 361024, Fujian, China