



VS360

IR Breakbeam People Counter

User Guide

Contents

| | |
|---|-----------|
| Chapter 1. Preface | 4 |
| Copyright Statement..... | 4 |
| Safety Instruction..... | 4 |
| Revision History..... | 4 |
| Chapter 2. Product Introduction | 6 |
| Overview..... | 6 |
| Key Features..... | 6 |
| Chapter 3. Hardware Introduction | 7 |
| Packing List..... | 7 |
| Hardware Overview..... | 7 |
| Button Description..... | 8 |
| Dimensions (mm)..... | 9 |
| Chapter 4. Power Supply | 10 |
| Chapter 5. Quick Start | 11 |
| Access the Sensor via NFC..... | 11 |
| Configure the Network Setting..... | 12 |
| Chapter 6. Operation Guide | 13 |
| LoRaWAN [®] Settings..... | 13 |
| General Settings..... | 16 |
| Time Synchronization..... | 19 |
| Advanced Settings..... | 20 |
| Threshold Settings..... | 20 |
| Milesight D2D Settings..... | 21 |
| Maintenance..... | 23 |
| Upgrade..... | 23 |
| Backup and Restore..... | 24 |
| Reset to Factory Default..... | 26 |

| | |
|--|-----------|
| Chapter 7. Installation..... | 28 |
| Preparation before Installation..... | 28 |
| Installation Position..... | 28 |
| Installation Requirement..... | 28 |
| Installation Step..... | 29 |
| Uninstallation..... | 31 |
| Factors Affecting Accuracy..... | 31 |
| Chapter 8. Uplink and Downlink..... | 33 |
| Overview..... | 33 |
| Uplink Data..... | 33 |
| Basic Information..... | 33 |
| Periodic Report..... | 34 |
| Alarm Report..... | 35 |
| Historical Data..... | 36 |
| Downlink Command..... | 37 |
| General Setting | 37 |
| Alarm Setting..... | 41 |
| Milesight D2D Setting | 42 |
| Historical Data Enquiry..... | 43 |
| Chapter 9. Services..... | 46 |

Chapter 1. Preface

Copyright Statement

This guide may not be reproduced in any form or by any means to create any derivative such as translation, transformation, or adaptation without the prior written permission of Xiamen Milesight IoT Co., Ltd (Hereinafter referred to as Milesight).

Milesight reserves the right to change this guide and the specifications without prior notice. The latest specifications and user documentation for all Milesight products are available on our official website <http://www.milesight.com>

Safety Instruction

These instructions are intended to ensure that user can use the product correctly to avoid danger or property loss. Milesight will not shoulder responsibility for any loss or damage resulting from not following the instructions of this operating guide.



CAUTION:

Injury or equipment damage may be caused if any of these cautions are neglected.

- The device is not intended to be used as a reference sensor, and Milesight will not should responsibility for any damage which may result from inaccurate readings.
- The device must not be disassembled or remodeled in any way.
- Do not place the device close to objects with naked flames.
- Do not place the device where the temperature is below/above the operating range.
- Make sure electronic components do not drop out of the enclosure while opening.
- When installing the battery, please install it accurately, and do not install the reverse or wrong model.
- The device must never be subjected to shocks or impacts.
- In order to protect the security of the device, please change device password when first configuration. The default password is 123456.

Revision History

| Release Date | Version | Revision Content |
|-----------------|---------|------------------|
| August 16, 2024 | V1.0 | Initial version |

| Release Date | Version | Revision Content |
|------------------|---------|--|
| August 15, 2025 | V1.1 | Support to report data on the dot. |
| October 15, 2025 | V1.2 | Battery pre-installed in the device and removed from packing list. |

Chapter 2. Product Introduction

Overview

The VS360 is a people counting sensor that is based on IR Breakbeam technology. Equipped with two devices, the principle is that the target blocks the infrared beam by detecting the area to achieve the purpose of counting, so it is not affected by the ambient temperature and the color of the target clothes, and it has strong adaptability. Adjusting the current of the node device reduces the power consumption and extends the battery life. As a Milesight D2D controller, the VS360 seamlessly communicates with other Milesight D2D agent devices, establishing more possible connections and paving the way for smoother operations.

With easy configuration and wireless detection, the VS360 facilitates simple deployment and connectivity. Compliant with the Milesight LoRaWAN[®] gateway and Milesight Development Platform, users can know the number of passage people and trigger other sensors or appliances easily.

Key Features

- Provide good accuracy rate for bi-directional people counting without sunlight interference
- Based on IR Breakbeam technology which is not affected by ambient temperature with more adaptability
- Ultra-low power consumption with up to 3-year battery life without replacement
- Wireless connectivity and convenient size improve the accessibility and simplicity of deployment
- Visual data about people counting via screen
- Smart scheduled hibernate mode to save battery power
- Support Milesight D2D protocol to enable ultra-low latency and directly control without gateways
- Equipped with NFC for one touch configuration and support card emulation mode
- Function well with standard LoRaWAN[®] gateways and network servers
- Compatible with the Milesight Development Platform

Chapter 3. Hardware Introduction

Packing List

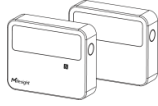

1 × VS360 Sensor



2 × Back Covers



4 × Ceiling Mounting Kits

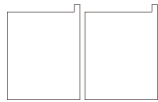

2 × 3M Double-sided Tapes



1 × Warranty Card



1 × Quick Guide



Note:

If any of the above items are missing or damaged, please contact your sales representative.

Hardware Overview

Master Device:

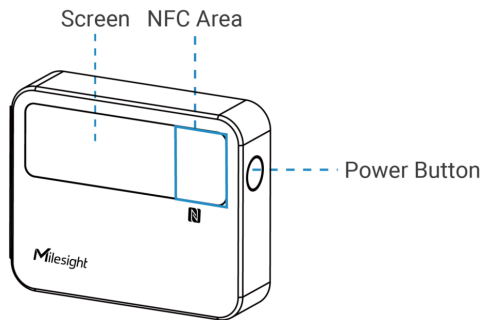

Battery Compartment Reset Button

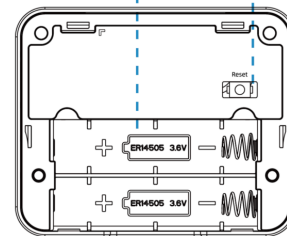

Node Device:

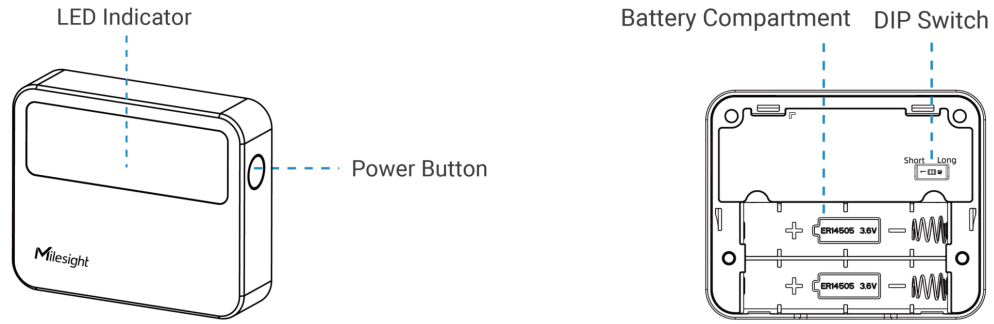

Button Description

Master Device

| Function | Action | Screen |
|--------------------------------|---|----------------------------------|
| Power On/Off | Press and hold the power button for 5s | Display "Hello"/"GoodBye" |
| Light Up Screen | Press power button once | Light on |
| Reset Accumulated People Value | After the screen lights up, press and hold on the power button for 2s | Accumulated counting value reset |
| Reset to Factory Default | Press and hold on the reset button for 10s | Display reset frames |

Node Device

| Function | Action | LED Indicator |
|---------------------|---|--|
| Power On/Off | Press and hold on the power button for 5s | Power On: Off → On Power Off: On → Off |
| Check On/Off Status | Press power button once | Light On: device is on Light Off: device is off |

Dimensions (mm)

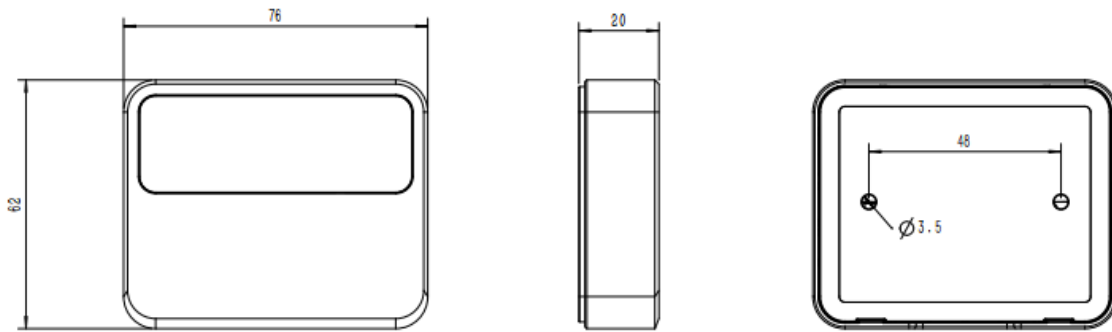

Chapter 4. Power Supply

1. Use screwdriver to remove the back cover of both the master and node devices.

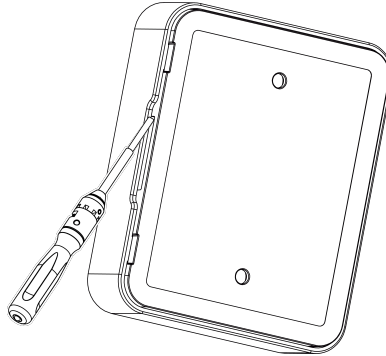

2. Remove the battery insulation sheet from each device.

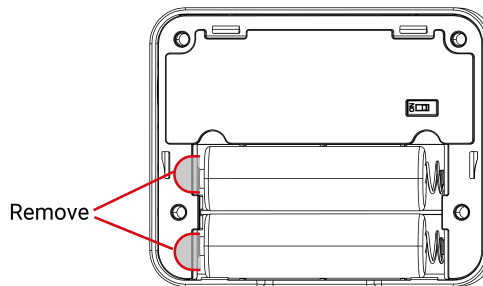

3. Press and hold the power button for 3 seconds to turn on the devices.



Note:

- The device can only be powered by ER14505 Li-SOCl₂ batteries and does not support the use of alkaline batteries.
- If the device is not used for a long period of time, please remove the batteries, otherwise it may cause battery leakage and damage to the internal components.
- When replacing batteries, ensure all batteries are newest; otherwise, it may shorten battery life or cause inaccurate power calculations.

Chapter 5. Quick Start

This chapter describe the steps to quickly configure this device to set up the connection with LoRaWAN[®] gateway and network server. If you requires more advanced settings, please refer to operation guide chapter.

Access the Sensor via NFC

1. Download and install "Milesight ToolBox" App from Google Play or Apple Store on an NFC-supported smartphone.
2. Enable NFC function on the smartphone.
3. Launch Milesight ToolBox, and select the default mode as NFC.
4. Attach the smart phone with NFC area to the device and click  to read device information. Basic information, data, and settings of the device will be shown on the Milesight ToolBox App if it's recognized successfully.
5. Adjust the settings on the App, then attach the smartphone with NFC area to the device and click **Write** to write the settings. After writing, reread the device to check if the configuration is written well.



Note:

- Ensure the location of smartphone NFC area and it's recommended to take off phone case.
- If the smart phone fails to read/write configurations via NFC, keep the phone away and back to try again.
- The default device password is 123456. Please change a new password for security.

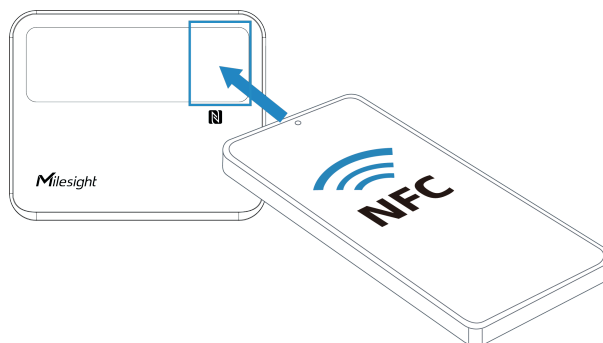

Configure the Network Setting

1. Go to **Network** settings page, select the join type as OTAA or ABP as required.



Note:

OTAA mode is required if you connect device to Milesight IoT Cloud or Milesight Development Platform.

2. Select supported frequency the same as LoRaWAN[®] gateway.



Note:

Set the channel index as 8-15 for US915 or AU915 if using default settings of Milesight gateways.

Device
Network

LoRaWAN

* Support Frequency

US915 ▼

Enable Channel Index ⓘ

8-15

| Index | Frequency/MHz ⓘ |
|---------|---|
| 0 - 15 | 902.3 - 905.3 |
| 16 - 31 | 905.5 - 908.5 |
| 32 - 47 | 908.7 - 911.7 |
| 48 - 63 | 911.9 - 914.9 |
| 64 - 71 | 903 - 914.2 |

3. Keep other settings by default and click **Write** to save the settings.

Chapter 6. Operation Guide

LoRaWAN[®] Settings

Configure AppEUI, Join Type, Application Key, and other information. You can also keep all the default settings.

Device EUI
24E124824E308175



* APP EUI
24e124c0002a0001

* Application Port
85

LoRaWAN Version
V1.0.3

Work Mode
Class A

| Parameters | Description |
|------------------------------|---|
| Device EUI | Unique ID of the device which can be found on the device.  Note: please contact sales for device EUI list if you have many units. |
| App EUI | The default App EUI (join EUI) is 24E124C0002A0001. |
| Application Port | The port used for sending and receiving data, the default port is 85. |
| LoRaWAN [®] Version | V1.0.2 and V1.0.3 are available. |
| Work Mode | It's fixed as Class A. |
| Confirmed Mode | If the device does not receive ACK packet from network server, it will resend data once. |
| Join Type | OTAA or ABP mode is available. |

| Parameters | Description |
|-------------------------|---|
| | <p> Note: It's necessary to select OTAA mode if connecting device to Milesight Development Platform.</p> |
| Application Key | <p>Appkey for OTAA mode, default value: "Device EUI" + "Device EUI" (since Q4 of 2025). Example: 24e124123456789024e1241234567890</p> <p> Note:</p> <ul style="list-style-type: none"> • The default value of earlier devices is 5572404C696E6B4C6F52613230313823. • Please contact sales before purchase if you require random App Keys. |
| Network Session Key | Nwkskey for ABP mode, the default is 5572404C696E6B4C6F52613230313823. |
| Application Session Key | Appskey for ABP mode, the default is 5572404C696E6B4C6F52613230313823. |
| Device Address | DevAddr for ABP mode, default is the 5 th to 12 th digits of SN. |
| Rejoin Mode | <p>Reporting interval ≤ 35 mins: the device will send a specific number of LinkCheck-Req MAC packets to the network server every reporting interval or every double reporting interval to validate connectivity; If there is no response, the device will re-join the network.</p> <p>Reporting interval > 35 mins: the device will send a specific number of LinkCheck-Req MAC packets to the network server every reporting interval to validate connectivity; If there is no response, the device will re-join the network.</p> |

| Parameters | Description |
|---------------------|---|
| |  Note: <ol style="list-style-type: none"> 1. Only OTAA mode supports rejoin mode. 2. The actual sending number is Set the number of packets sent +1. |
| Channel Mode | Select Standard-Channel mode or Single-Channel mode. When Single-Channel mode is enabled, only one channel can be selected to send uplinks. |
| Supported Frequency | <p>Enable or disable the frequency to send uplinks. If frequency is one of CN470/AU915/US915, enter the index of the channel to enable in the input box, making them separated by commas.</p> <p>Examples:</p> <p>1, 40: Enabling Channel 1 and Channel 40</p> <p>1-40: Enabling Channel 1 to Channel 40</p> <p>1-40, 60: Enabling Channel 1 to Channel 40 and Channel 60</p> <p>All: Enabling all channels</p> <p>Null: Indicate that all channels are disabled</p> |
| ADR Mode | Enable or disable network server to adjust Spreading Factor, Bandwidth an Tx Power to optimize data rates, airtime and energy consumption in the network. |
| Spreading Factor | If ADR mode is disabled, the device will send uplink data following this SF parameter. The higher the spreading factor, the longer the transmission distance, the slower the transmission speed and the more the consumption. |
| Tx Power | Tx power (transmit power) refers to the strength of the outgoing signal transmitted by the device. This is defined by LoRa alliance. |
| RX2 Data Rate | RX2 data rate to receive downlinks or send D2D commands. |
| RX2 Frequency | RX2 frequency to receive downlinks or send D2D commands. Unit: Hz |

General Settings

Reporting Mode

Reporting Interval

Reset Accumulated Value

Reset Time Every Sun. >

Data Storage ⓘ

Data Retransmission ⓘ



Report Accumulated Value



Hibernate Mode

Screen Power Switch

Counting Mode ⓘ

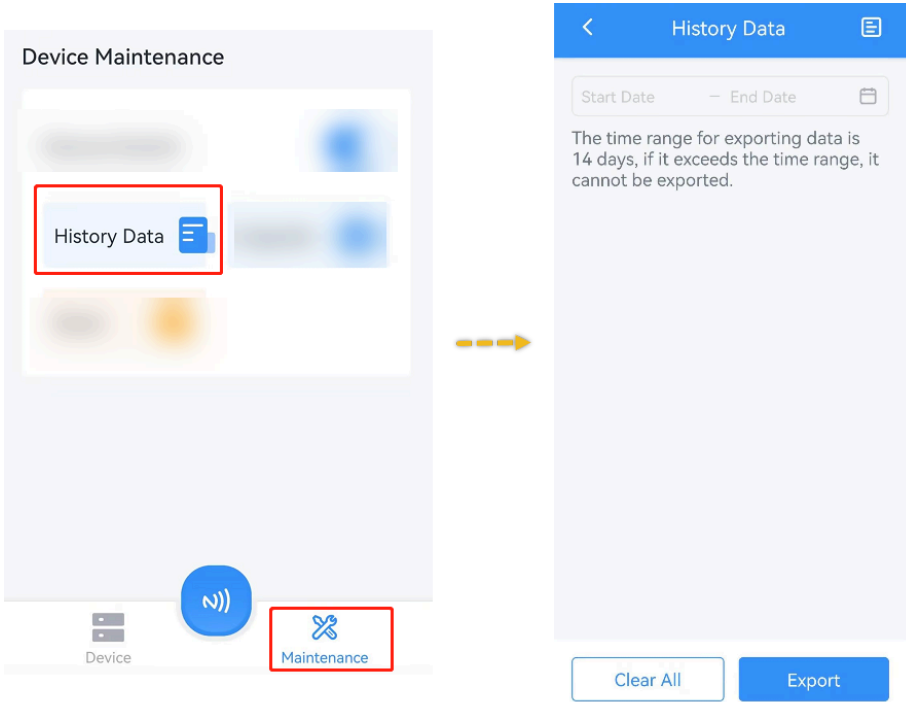
| Parameters | Description |
|-------------------------|--|
| Reporting Mode | <p>Select the periodic reporting mode: "On the Dot" or "From Now On".</p> <p>On the Dot: Report at regular time marks. For example, if the current time is 0:07 and the interval is set to 10 minutes, reports will be sent at 0:10, 0:20, 0:30, etc.</p> <p>From Now On: Start reporting immediately and continue at regular intervals from that point forward.</p> |
| Reporting Interval | The time interval for reporting people counting data and battery level to the network server. Default: 10 minutes. |
| Reset Accumulated Value | Enable or disable automatic reset of accumulated in/out counting values. Before resetting the accumulated value, the device reports the current accumulated value once, and then clears it. |

| Parameters | Description |
|--------------|--|
| | <p> Note: the device will reset automatically when accumulate counting values reaches 65535 even this option is disabled.</p> |
| Reset Time | <p>The time to reset accumulated in/out counting values.</p> <p> Note: The cumulative value will be reported once before reset.</p> |
| Data Storage | <p>Disable or enable to store periodic report data locally. The stored data can be exported as CSV format file and saved to smartphone via ToolBox.</p>  |

| Parameters | Description |
|--------------------------|---|
| | <p> Note:</p> <ol style="list-style-type: none"> 1. It is necessary to sync the time to ensure the data is stored in correct time. 2. The device will still store the data even the network status is de-activated. 3. ToolBox App can only export the last 14 days' data at most. |
| Data Retransmission | <p>Disable or enable data retransmission. When the device detects the network status is de-activated via Rejoin Mode, the device will record a data lost time point and re-transmit the lost data after device re-connects to the network.</p> <p> Note:</p> <ol style="list-style-type: none"> 1. This setting only takes effect when Data Storage is enabled. 2. If the device is rebooted or re-power when data retransmission is not completed, the device will re-send all retransmission data again after device is reconnected to the network. 3. If the network is disconnected again during data retransmission, it will only send the latest disconnected data. 4. The default report data retransmission interval is 600s, this can be changed via downlink command. 5. The reported format of retransmission data will include time-stamps and is different from periodic report data. 6. This setting will increase the uplink frequencies and shorten the battery life. |
| Report Accumulated Value | Disable or enable to report accumulated counting values in periodic packets. |
| Hibernate Mode | Disable or enable Hibernate mode and configure the Hibernation Period. It will stop counting and reporting when hibernating. |
| Hibernate Period | Set hibernation period. |

| Parameters | Description |
|---------------------|--|
| Screen Power Switch | Enable or disable screen display. The display content includes battery level, people counting and align status. |
| Counting Mode | High Traffic Period Mode: Suitable for scenarios with high foot traffic. Low Traffic Period Mode: Suitable for scenarios with low foot traffic. |
| Change Password | Change the password for ToolBox App to write this device. |

Time Synchronization

This section describes how to sync the time of the device.

Sync via ToolBox App

After reading the device via Milesight ToolBox App, sync the device time with time zone from the smart phone.

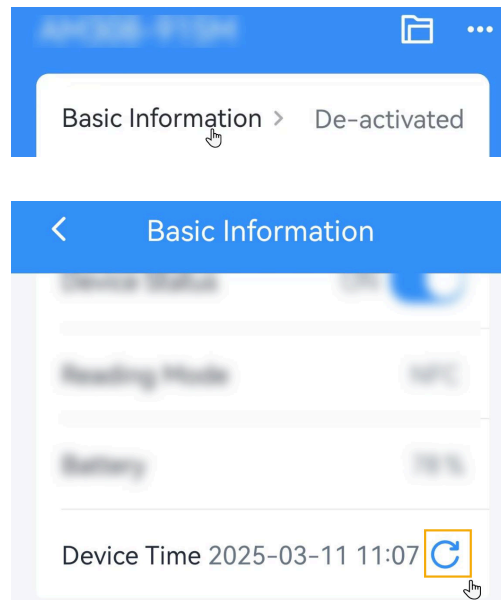

Sync via Network Server

This requires to ensure the LoRaWAN[®] network server supports device time synchronization feature. Example: Milesight gateway embedded NS.

1. Set the LoRaWAN[®] version of the device to V1.0.3.
2. Connect the device to the network server. After joining the network, the device will send a DeviceTimeReq MAC command to enquire the time from network server.

**Note:**

- This only supports to get the time but not time zone. The time zone can be configured by ToolBox App or downlink command.
- The device will send the DeviceTimeReq command every 5 days since the last sync.

Advanced Settings

Threshold Settings

If the threshold is triggered, the device will report the threshold alarm packet instantly.

Periodic People Count

In >

Out >

Cumulative People Count

Accumulated In >

Accumulated Out >

| Parameter | Description |
|-----------------------|--|
| Periodic People Count | During each reporting interval, when the number of people reaches the set threshold, the device will send a alarm packet once. At the end of the interval, the count is reset to zero, and the next reporting interval begins. |

| Parameter | Description |
|-------------------------|---|
| Cumulative People Count | When the device is powered on for the first time or after the accumulated count is reset, it sends an alarm data packet once the cumulative people count reaches the set threshold. |

Milesight D2D Settings

Milesight D2D protocol is developed by Milesight and used for setting up transmission among Milesight devices without gateway. When the Milesight D2D settings is enabled, the device can work as a D2D controller to send control commands to trigger Milesight D2D agent devices.

1. Configure the RX2 datarate and RX2 frequency.



Note:

It is suggested to change the default values if there are many LoRaWAN[®] devices around.

Device Network

LoRaWAN D2D

Spreading Factor ⓘ
 SF12-DR0

TXPower
 TXPower0-16 dBm

RX2 Data Rate ⓘ
 DR0 (SF12, 125 kHz)

RX2 Frequency ⓘ
 869525000

2. Enable and configure the threshold alarm settings.

3. Enable Milesight D2D feature and define a unique D2D key that is the same as Milesight D2D agent devices. (Default D2D key: 5572404C696E6B4C6F52613230313823)

4. Enable one of statuses and configure 2-byte hexadecimal Milesight D2D command.



Note:

- If you enable **LoRa Uplink**, a LoRaWAN[®] uplink packet that contains corresponding alarm status will be sent to gateway after the Milesight D2D command packet. Otherwise, the alarm packet will not send to LoRaWAN[®] gateway.
- If you enable the **Control Time** setting, Milesight D2D agent devices will take corresponding actions within this duration after receiving commands from Milesight D2D controller. This feature is currently under development for Milesight D2D agent devices.

Example:

When someone is left, the device will send D2D command 0004 to Milesight D2D agent devices, which perform the corresponding action for 5 minutes.

| | |
|-------------------------------------|-------------------------------------|
| Someone Entered | <input type="checkbox"/> |
| Someone Left | <input checked="" type="checkbox"/> |
| Control command | <input type="text" value="0004"/> |
| LoRa Uplink ⓘ | <input type="checkbox"/> |
| Control Time(min) ⓘ | <input checked="" type="checkbox"/> |
| | <input type="text" value="5"/> |
| <hr/> | |
| People Counting Threshold Triggered | <input type="checkbox"/> |

Maintenance

Upgrade

This chapter describes the steps to upgrade the device via ToolBox App.

1. Download firmware from Milesight official website to your smartphone.
2. Read the target device via ToolBox App, click **Upgrade** to upload the firmware file.
3. Click **Upgrade** to upgrade the device.



Note:

- Operation on ToolBox is not supported during an upgrade.
- Only Android version ToolBox supports the upgrade feature.

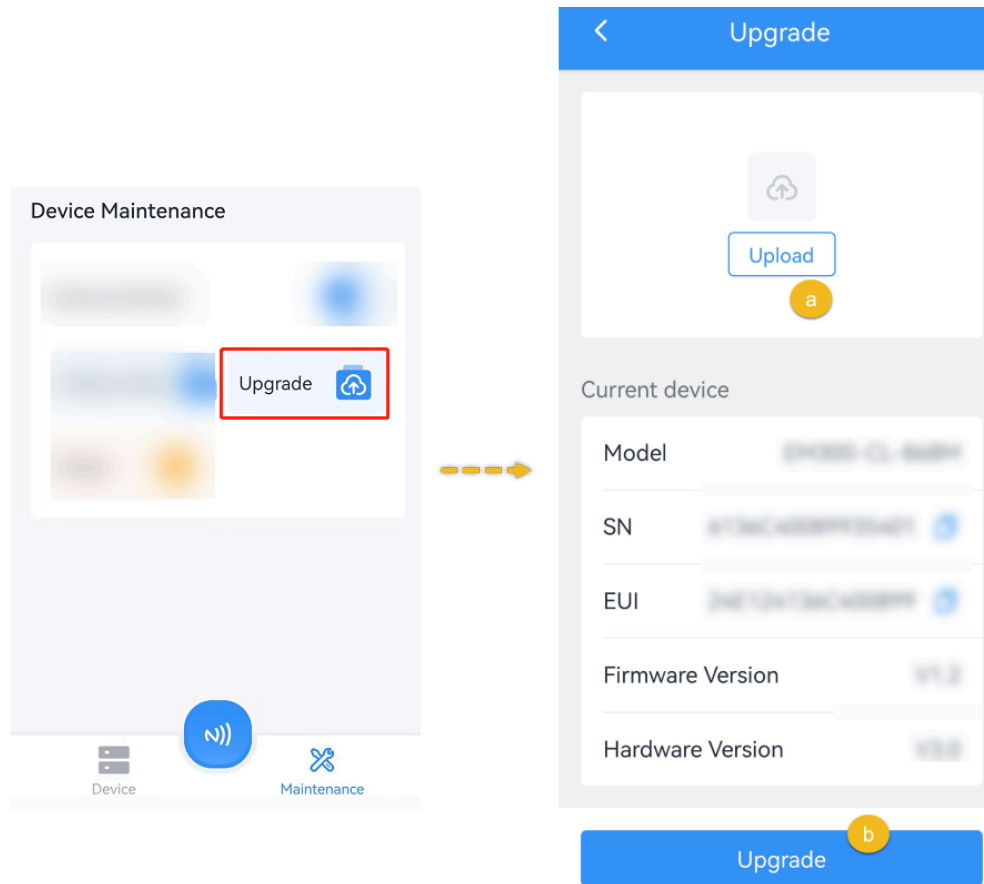

Backup and Restore

This device supports configuration backup for easy and quick device configuration in bulks. Backup and restore is allowed only for devices with the same model and frequency band.

Backup and Restore

1. Launch ToolBox App, attach the NFC area of smartphone to the device to read the configuration.
2. Edit the configuration as required, click **Set Template** to save current configuration as a template to the ToolBox App.

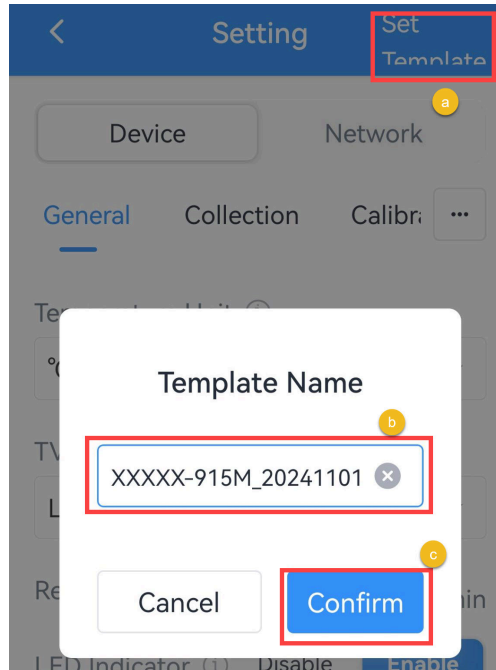

3. Go to **Device >Template** page.



4. Select and click the target template, click **Write** to import the configuration to target devices.

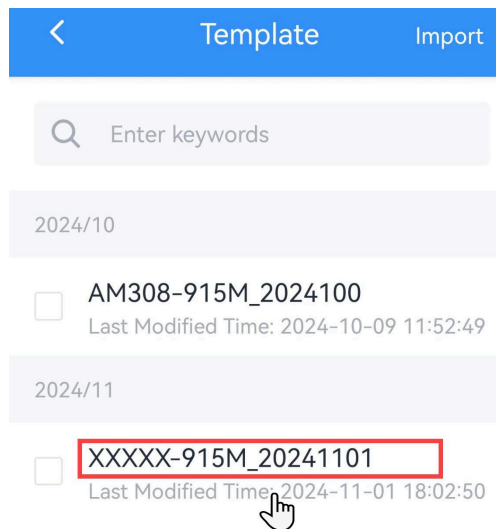

Export and Delete Template

1. Check the box of the target template.
2. Click **Export** to export this template as JSON format file and save it to the smartphone, click **Delete** to delete this template from your Toolbox App.

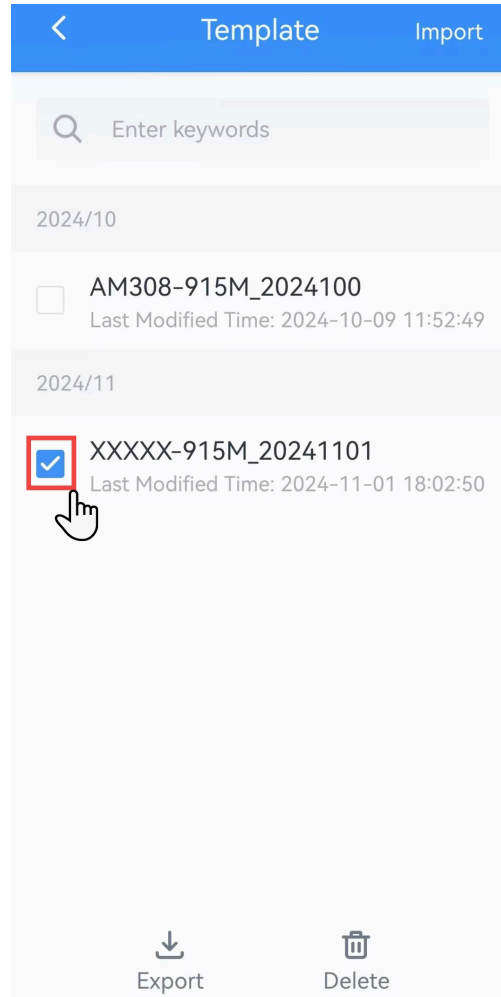

Reset to Factory Default

Via Hardware: Hold on the reset button for more than 10s until the LED indicator quickly blinks.

Via Toolbox App: Click **Reset** and attach the smartphone to device to reset the device.

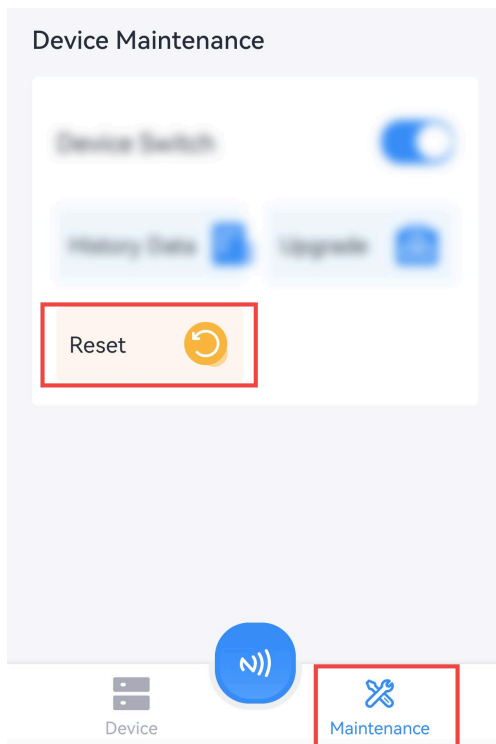

Chapter 7. Installation

Preparation before Installation

Installation Position

1. Avoid exposing the device to direct sunlight.
2. Avoid placing the device near reflective surfaces such as glass, which may affect detection accuracy.
3. Avoid exposing the master device to areas where an IR device is around (IR remote controller, etc.).
4. The best installation height is 0.7~1.2m from the ground.
5. The recommended detection range is 1.2~3m.
6. Ensure that there are no obstructions between the master and node devices, and that they are **aligned parallel** to each other.

Installation Requirement

There are two ways to fix the devices: 3M Tape or Mounting Kits. Please check the precautions before selecting the appropriate installation method.

Fixed by 3M Tape

**Note:**

To ensure the devices are securely installed and prevent them from falling due to adhesive peeling, please strictly adhere to the following requirements:

1. Install the device on a dry, smooth, sturdy, grease-free wall.
2. Do not install the device on rough, damp, crumbling, greasy, or wallpapered walls.
3. Before installation, wipe the wall with a clean cloth to ensure it is free of dust and grease.
4. After adhering the device to the wall, press firmly to ensure it is fully adhered. Allow 24 hours for the best adhesion results.
5. If the wall conditions do not meet the above requirements, choose an alternative installation method, such as screw fixation.

Fixed by Mounting Kits

**Note:**

1. Wall materials must have sufficient strength and stability to ensure that screws are securely fastened and the overall structure is sturdy.
2. Screws should be fastened in locations that avoid electrical wiring, water pipes, and other elements within the wall to prevent damage to the wall structure or safety hazards.

Installation Step

Step 1: Remove the back cover of the node device, determine the installation position of the node device at a height of 0.7~1.2 meters above the ground, then use 3M tape or the mounting kits to attach it to a wall or other surface.

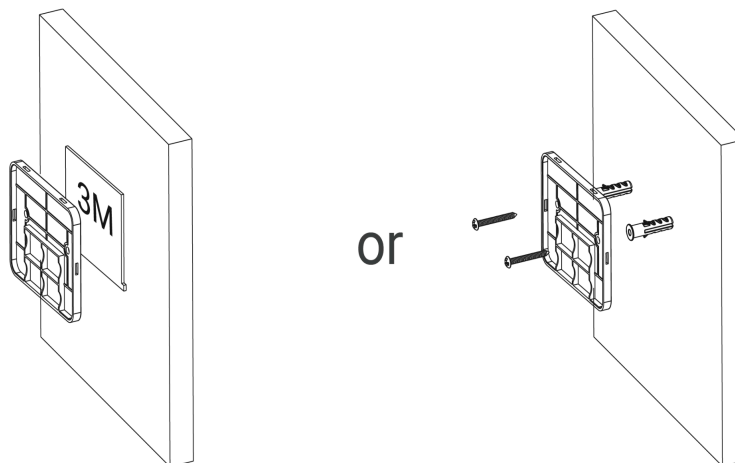

Step 2: Adjust node device's DIP. The recommended detection range between node device and master device is 1.2~3m. If the range is 2 meters or less, set the DIP switch on the node device to the "Short" position; if the range exceeds 2 meters, set it to the "Long" position.

Step 3: Press the node device onto the back cover.

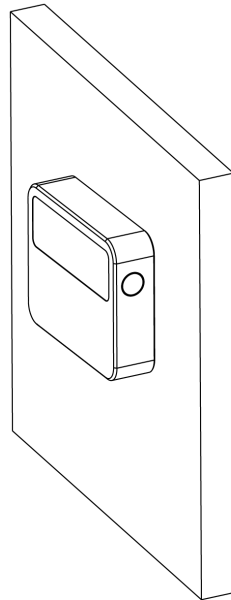

Step 4: Remove the master device, press and hold the side button to turn it on, ensure that the screen display is not blocked and verify the alignment results.

Step 5: Position the master device at a distance of 0.7~1.2 meters from the ground. Adjust its position according to the prompt on the screen by pressing the power button until a "✓" is displayed.

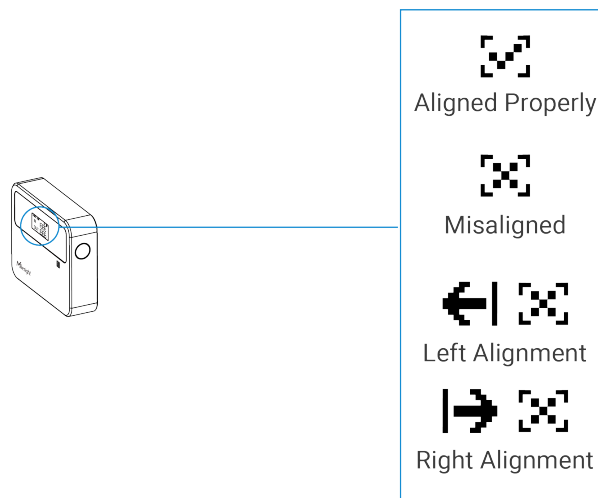

Step 6: Use a marker or similar tool to outline the position of the master device for mounting. Then, secure the back cover of the master device at this position using 3M tape or mounting kits.

Step 7: Press the master device onto the back cover.

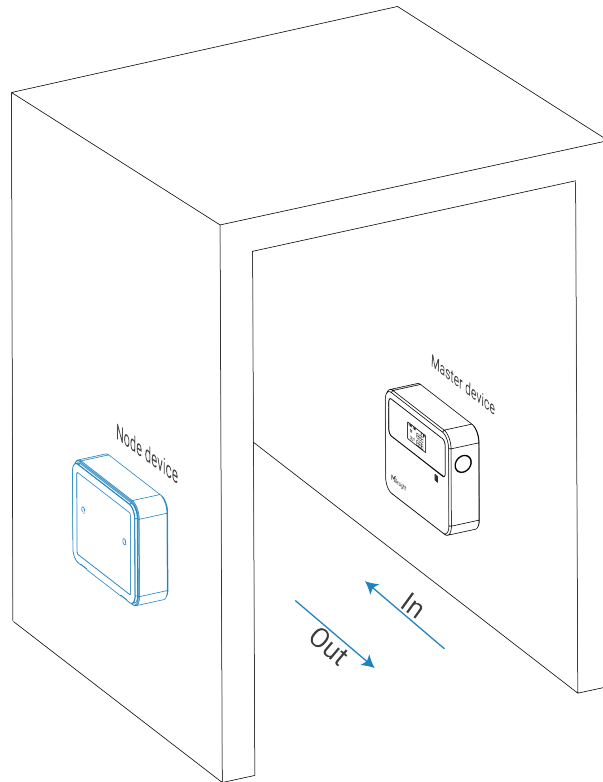

Uninstallation

Place your thumb on top of the device, grip the bottom of the device with your other fingers, and pull it out diagonally to remove the device.

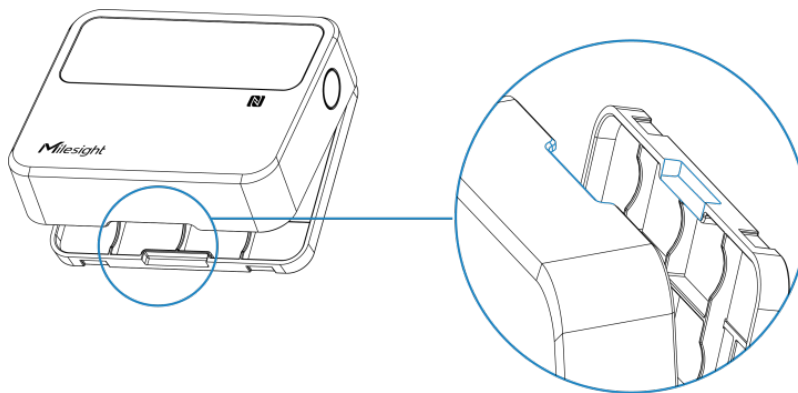

Factors Affecting Accuracy

- Two people passing through side by side will be counted as one person.
- Holding something with your hand raised or pushing a shopping cart may result in overcounting.
- Walking at speeds greater than 1.5 m/s may result in missed counts.

- When a single person closely follows another (with a distance of less than 20 cm), there is a chance of missing the count.
- Passing close to the node device or passing at an angle may result in reverse counting.

Chapter 8. Uplink and Downlink

Overview

All messages are based on following format (HEX), the Data field should follow little-endian:

| Channel1 | Type1 | Data1 | Channel2 | Type2 | Data2 | Channel3 | ... |
|----------|--------|---------|----------|--------|---------|----------|-----|
| 1 Byte | 1 Byte | N Bytes | 1 Byte | 1 Byte | N Bytes | 1 Byte | ... |

For decoder examples please find files on <https://github.com/Milesight-IoT/SensorDecoders>.

Uplink Data

Basic Information

The device will report a basic information packet whenever joining the network.

| Item | Channel | Type | Byte | Description |
|------------------|---------|------|------|---|
| Power On | ff | 0b | 1 | Device is on |
| Protocol Version | ff | 01 | 1 | Example: 01=V1 |
| Serial Number | ff | 16 | 8 | 16 digits |
| Hardware Version | ff | 09 | 2 | Example: 03 10 = V3.1 |
| Firmware Version | ff | 0a | 2 | 01 14 => V1.14 |
| Device Type | ff | 0f | 1 | 00: Class A, 01: Class B, 02: Class C, 03: Class C to B |

Example:

| ff0bff ff0101 ff166824e30817560003 ff090100 ff0a0101 ff0f00 | | |
|---|------|--------------------------|
| Channel | Type | Value |
| ff | 0b | Power On: ff(Reserved) |
| ff | 01 | Protocol Version: 01(V1) |
| ff | 16 | SN: 6824e30817560003 |

| ff0bff ff0101 ff166824e30817560003 ff090100 ff0a0101 ff0f00 | | |
|---|------|-------------------------------|
| Channel | Type | Value |
| ff | 09 | Hardware Version: 0100 (V1.0) |
| ff | 0a | Firmware Version: 0101(V1.1) |
| ff | 0f | Device Type: 00(Class A) |

Periodic Report

The device supports to report below types of periodic report packets.

| Item | Channel | Type | Byte | Description |
|---------------------------|---------|------|------|---|
| Battery Level | 01 | 75 | 1 | UINT8, Unit: %, master battery level |
| | 02 | | | UINT8, Unit: %, node battery level, update only once everyday |
| Accumulated Counter | 04 | cc | 4 | Byte 1-2: Accumulated In Byte 3-4: Accumulated Out |
| Periodic Counter | 05 | cc | 4 | Byte 1-2: Periodic In Byte 3-4: Periodic Out |
| Timestamp (On the dot) | 0a | ef | 4 | Unix Timestamp, Unit: s |

Examples:

1. Periodic packet: report as reporting interval (10 minutes by default), report mode is from now on.

| 017562 027562 05cc09000500 04cc09000200 | | |
|---|------|-------------------------------|
| Channel | Type | Value |
| 01 | 75 | Master battery level: 62=>98% |
| 02 | 75 | Node battery level: 62=>98% |
| 05 | cc | Periodic In: 09 00=> 00 09=9 |

| 017562 027562 05cc09000500 04cc09000200 | | |
|---|------|---|
| Channel | Type | Value |
| | | Periodic Out: 05 00=> 00 05=5 |
| 04 | cc | Accumulated In: 09 00=> 00 09=9 Accumulated Out: 02 00=> 00 02=2 |

2. Periodic packet: report mode is on the dot.

| 0aef 90d69968 05cc0c000500 017564 027562 | | |
|--|------|--|
| Channel | Type | Value |
| 0a | ef | Timestamp: 90d69968=>6899d690=>1754912400s |
| 05 | cc | Periodic In: 0c 00=> 00 0c=12 Periodic Out: 05 00=> 00 05=5 |
| 01 | 75 | Master battery level: 64=>100% |
| 02 | 75 | Node battery level: 62=>98% |

Alarm Report

The device supports to report below types of alarm report packets.

| Item | Channel | Type | Byte | Description |
|---------------------------|---------|------|------|---|
| Accumulated Counter Alarm | 84 | cc | 5 | Byte 1-2: Accumulated In Byte 3-4: Accumulated Out Byte 5: 01 |
| Periodic Counter Alarm | 85 | cc | 5 | Byte 1-2: Periodic In Byte 3-4: Periodic Out Byte 5: 01 |
| Abnormal Alarm | 03 | f4 | 2 | Byte 1: |

| Item | Channel | Type | Byte | Description |
|------|---------|------|------|---------------------------------|
| | | | | 00-Counting anomaly |
| | | | | 01-Node Device Without Response |
| | | | | 02-Devices Misaligned |
| | | | | Byte 2: |
| | | | | 00-Alarm dismiss |
| | | | | 01-Alarm |

Example:

1. People alarm packet: report when the periodic counting value reaches the threshold.

| 85cc 06000000 01 | | |
|------------------|------|--|
| Channel | Type | Value |
| 85 | cc | Periodic in: 0600=>0006=6 Periodic out: 0000=0 01= Threshold Alarm |

2. Abnormal Alarm: report when device is obstructed by an obstacle.

| 03f4 00 01 | | |
|------------|------|-------------------------------------|
| Channel | Type | Value |
| 03 | f4 | 00 = Counting anomaly. 01= Alarm |

Historical Data

The device will report retransmission data or stored data as below example.

| Channel | Type | Byte | Description |
|---------|------|------|-----------------------------------|
| 20 | ce | 9/13 | Byte 1-4: Unix Timestamp, Unit: s |

| Channel | Type | Byte | Description |
|---------|------|------|---|
| | | | Byte 5: 00-Periodic Counter 01-Periodic Counter + Accumulated Counter Byte 6-7: Periodic In Counter Byte 8-9: Periodic Out Counter Byte 10-11: Accumulated In Counter Byte 12-13: Accumulated Out Counter |

Example:

| 20ce 4a7c5b63 01 0700 0300 4a00 3800 | | | |
|--------------------------------------|------|--|--|
| Channel | Type | Time Stamp | Value |
| 20 | ce | 4a7c5b63 => 63 5b 7c 4a = 1666939978s | 01=Periodic Counter + Accumulated Counter Period In: 0700=>0007=7 Period Out: 0300=>0003=3 Accumulated In: 4a00=>004a=74 Accumulated Out: 3800=>0038=56 |

Downlink Command

The device supports downlink commands to configure the device. Application port is 85 by default.

General Setting

| Item | Channel | Type | Byte | Description |
|----------------------------|---------|------|------|---|
| Reboot | ff | 10 | 1 | ff |
| Current device information | ff | 28 | 1 | ff, including number of people, master device and node device electrical power consumption. |

| Item | Channel | Type | Byte | Description |
|------------------------------|---------|------|------|--|
| Reporting Mode | f9 | 10 | 1 | 00: From Now On, 01: On the Dot |
| Report Interval | ff | 8e | 3 | Byte 1: 00 Byte 2-3: UINT16, Unit: minute |
| Reset Accumulated Value | ff | a6 | 1 | 01: enable, 00: disable |
| Reset Accumulated Time | ff | ed | 3 | Byte 1: Reset date 00: Everyday; 01: Every Sunday; 02: Every Monday; 03: Every Tuesday ; 04: Every Wednesday; 05: Every Thursday; 06: Every Friday; 07: Every Saturday Byte 2: Reset hour Byte 3: Reset minute |
| Accumulated Counter Clearing | ff | a8 | 1 | 01: clear accumulate In counter 02: clear accumulate Out counter |
| Data Storage | ff | 68 | 1 | 00: Disable, 01: Enable |
| Data Retransmission | ff | 69 | 1 | 00: Disable, 01: Enable |
| Data Retransmission Interval | ff | 6a | 3 | Byte 1: 00 Byte 2-3: UINT16, Unit: s, Range: 30~1200, Default: 600 |

| Item | Channel | Type | Byte | Description |
|--------------------------|---------|------|------|--|
| Report Accumulated Value | ff | a9 | 1 | 01-enable, 00-disable |
| Hibernate Period | ff | 75 | 6 | Byte 1: 01-enable, 00-disable Byte 2-3: Start Time, unit: min Byte 4-5: End Time, unit: min Byte 6: Set Hibernate Period, Bit0=1 Bit7~Bit1: Sunday~Monday <div style="border: 1px solid #ccc; background-color: #e6f2ff; padding: 5px; margin-top: 10px;">  Note: if start time equals end time, it means all day. </div> |
| Screen Power Switch | ff | fd | 1 | 01: enable, 00: disable |
| Counting Mode | ff | fc | 1 | 02: Suitable for scenarios with high foot traffic, 03: Suitable for scenarios with low foot traffic. |

Examples:

1. Reboot the device.

| ff10ff | | |
|---------|------|-------|
| Channel | Type | Value |
| ff | 10 | ff |

2. Set Reset Accumulated Counter Time as Every Sunday 12: 20.

| ffed 01 0c 14 | | |
|---------------|------|---|
| Channel | Type | Value |
| ff | ed | 01=>Every Sunday Reset hour: 0c => 12 Reset minute: 14=> 20 |

3. Set report interval as 20 minutes.

| ff8e001400 | | |
|------------|------|----------------------|
| Channel | Type | Value |
| ff | 8e | 1400=>0014=20minutes |

4. Set Counting Mode as High foot traffic.

| fffc 02 | | |
|---------|------|------------------------|
| Channel | Type | Value |
| ff | fc | 02=> High foot traffic |

5. Set a hibernate period from 10:00 PM to 7:00 AM, Monday to Friday.

| ff75 01 2805 a401 3f | | |
|----------------------|------|---|
| Channel | Type | Value |
| ff | 75 | 01=> Enable Start Time: 2805=0528=1320 min=>10:00 PM End Time: a401=01a4=420 min=>7:00 AM Period: 3f=00111111=> Monday to Friday |

Alarm Setting

| Item | Channel | Type | Byte | Description |
|----------------------|---------|------|------|--|
| Thresh- old Alarm | ff | 06 | 9 | Byte 1: Bit0~Bit2: 000-disable 001-below (minimum threshold) 010-over (maximum threshold) 011-within 100-below or over Bit3~Bit5: 001-Periodic Counter threshold 010-Accumulated Counter threshold Bit6~Bit7: 11 Byte 2-3: Min. value Byte 4-5: Max. value Byte 6-9: 00000000 |

Example:

Set people counting threshold alarm.

| ff06 d4 9600 2c01 00000000 | | |
|----------------------------|------|--|
| Channel | Type | Value |
| ff | 06 | d4=>11 010 100: 100=below or over, 010=Accumulated Counter threshold Min. value: 96 00=>00 96=15 |

| ff06 d4 9600 2c01 00000000 | | |
|----------------------------|------|-----------------------------|
| Channel | Type | Value |
| | | Max. value: 2c 01=>01 2c=30 |

Milesight D2D Setting

| Item | Channel | Type | Byte | Description |
|--------------|---------|------|------|--|
| D2D Feature | ff | 84 | 1 | 00: Disable, 01: Enable |
| D2D Key | ff | 35 | 8 | The first 16 digits of D2D key, and the last 16 digits are fixed as 0. |
| D2D Settings | ff | 96 | 8 | <p>Byte 1:</p> <p>01-Someone Entered</p> <p>02-Someone Left</p> <p>03-People Counting Threshold Triggered</p> <p>Byte 2: 01-enable, 00-disable</p> <p>Byte 3:</p> <p>01-enable LoRa Uplink,</p> <p>00-disable LoRa Uplink</p> <p>Byte 4-5: D2D control command</p> <p>Byte 6-7: control time, unit: min</p> <p>Byte 8:</p> <p>00-disable control time,</p> <p>01-enable control time</p> |

Example:

1. Set D2D Key as 12345678123456780000000000000000.

| ff35 1234567812345678 | | |
|-----------------------|------|------------------|
| Channel | Type | Value |
| ff | 35 | 1234567812345678 |

2. Set D2D settings.

| ff96 03 01 01 04e0 0500 01 | | |
|----------------------------|------|---|
| Channel | Type | Value |
| ff | 96 | <p>03=> People counting threshold triggered;</p> <p>01=>Enable;</p> <p>01=>Enable LoRa Uplink;</p> <p>04 e0=>e0 04, Control Command is e0 04;</p> <p>05 00=>00 05, Control time is 5 mins;</p> <p>01=>Enable Control Time</p> |

Historical Data Enquiry

The device supports data retrievability feature to send downlink command to enquire the historical data stored in the device. Before that, ensure the device time is correct and data storage feature was enabled to store data.

Command Format:

| Item | Channel | Type | Byte | Description |
|----------------------------|---------|------|------|--|
| Enquire Data in Time Point | fd | 6b | 4 | Unix timestamp, Unit: s |
| Enquire Data in Time Range | fd | 6c | 8 | Byte 1-4: Start timestamp, Unit: s Byte 5-8: End timestamp, Unit: s |
| Stop Query Data Report | fd | 6d | 1 | ff |

| Item | Channel | Type | Byte | Description |
|-------------------------|---------|------|------|--|
| Data Retrieval Interval | ff | 6a | 3 | Byte 1: 01 Byte 2-3: UINT16, Unit: s, Range: 30~1200, Default: 60 |

Reply Format:

| Item | Channel | Type | Byte | Description |
|----------------|---------|-------|------|--|
| Enquiry Result | fc | 6b/6c | 1 | 00: Enquiry success. The device will report the historical data according to data retrievability interval. 01: Time point or time range invalid 02: No data in this time or time range |

**Note:**

1. Use [Unix Timestamp Converter](#) to calculate the time.
2. The device only uploads no more than 300 data records per range enquiry.
3. When enquiring the data in time point, it will upload the data which is closest to the search point within the reporting interval range. For example, if the device's reporting interval is 10 minutes and users send command to search for 17:00's data, if the device find there is data stored in 17:00, it will upload this data; if not, it will search for data between 16:50 to 17:10 and upload the data which is closest to 17:00.

Example:

Enquire the historical data in a time range.

| fd6c 64735b63 7c885b63 | | |
|------------------------|------|--|
| Channel | Type | Value |
| fd | 6c | Start time: 64 73 5b 63 => 63 5b 73 64 = 1666937700s End time: 7c 88 5b 63 => 63 5b 88 7c = 1666943100s |

Reply:

| fc6c00 | | |
|---------|------|---------------------|
| Channel | Type | Value |
| fc | 6c | 00: Enquiry success |

| 20ce 4a7c5b63 01 0700 0300 4a00 3800 | | | |
|--------------------------------------|------|--|---|
| Channel | Type | Time Stamp | Value |
| 20 | ce | 4a7c5b63 => 63 5b 7c 4a = 1666939978s | 01=Periodic Counter + Accumulated Counter Period In: 0700=>0007=7 Period Out: 0300=>0003=3 Accumulated In: 4a00=>004a=74 Accumulated Out: 3800=>0038=56 |

Chapter 9. Services

Milesight provides customers with timely and comprehensive technical support services. End-users can contact your local dealer to obtain technical support. Distributors and resellers can contact directly with Milesight for technical support.

Technical Support Mailbox: iot.support@milesight.com

Online Support Portal: <https://support.milesight-iot.com>

Resource Download Center: <https://www.milesight.com/iot/resources/download-center/>

MILESIGHT CHINA

TEL: +86-592-5085280

FAX: +86-592-5023065

Add: Building C09, Software Park Phase III, Xiamen 361024, Fujian, China