



Smart Radiator Thermostat

WT102

User Guide

Contents

Chapter 1. Preface.....	4
Chapter 2. Product Introduction.....	5
Overview.....	5
Packing List.....	5
Hardware Introduction.....	6
Chapter 3. Installation.....	10
Chapter 4. Power Supply.....	12
Chapter 5. ToolBox App Configuration.....	14
Access the Device Using NFC.....	14
Synchronize Device Time.....	15
Configure LoRaWAN® Parameters.....	17
Configure the Device Parameters.....	24
Change the Device Password.....	24
Configure General Parameters.....	26
Configure Temperature Control Parameters.....	29
Configure Data Storage & Retransmission.....	36
Configure Calibration Parameters.....	39
Configure Temperature Threshold Parameters.....	42
Configure Schedule Parameters.....	44
Maintain the Device.....	46
Upgrade the Device.....	46
Configure a Template for Configuration Backup.....	47
Reset the Device.....	50
Chapter 6. Uplink Packets and Downlink Commands.....	52
Uplink Packets.....	52
Basic Information Packet.....	52
Periodic Data Packet.....	53

Alarm Report.....	56
Motor Stroke Calibration Packet.....	57
Downlink Commands.....	58
Commands for General Setting.....	59
Commands for Temperature Control Settings.....	62
Commands for Calibration Settings.....	64
Command for Threshold Setting.....	65
Commands for Schedule Settings.....	66
Commands for Historical Data Query.....	67
Chapter 7. Services.....	70

Chapter 1. Preface

Copyright Statement

This guide may not be reproduced in any form or by any means to create any derivative such as translation, transformation, or adaptation without the prior written permission of Xiamen Milesight IoT Co., Ltd (Hereinafter referred to as Milesight).

Milesight reserves the right to change this guide and the specifications without prior notice. The latest specifications and user documentation for all Milesight products are available on our official website <http://www.milesight.com>

Safety Instruction

These instructions are intended to ensure that users can use the product correctly to avoid danger or property loss. Milesight will not take responsibility for any loss or damage resulting from failure to follow the instructions in this operating guide.



CAUTION:

Injury or equipment damage may be caused if any of these cautions are neglected.

- The device is intended only for indoor use.
- The device is not intended to be used as a reference sensor, and Milesight will not take responsibility for any damage which may result from inaccurate readings.
- The device must not be disassembled or remodeled in any way.
- Do not place the device close to objects with naked flames.
- Do not place the device where the temperature is below/above the operating range.
- The device must never be subjected to shocks or impacts.
- To protect the security of the device, please change the device password when first configuring.
- To prevent heat accumulation, do not block air circulation around the device.

Revision History

Release Date	Version	Revision Content
Jan. 30, 2026	V1.0	Initial version

Chapter 2. Product Introduction

This chapter describes basic product information.

Overview

WT102 is a LoRaWAN[®] radiator thermostat designed to help manage the heating control system. It uses thermal energy harvesting to power itself, eliminating the need for battery replacement or a wired power connection, thus reducing maintenance costs. With one preset date period and up to 16 customized heating plans, it enables the smart management of the heating system. WT102 is a smart and highly environmentally-sensitive product. Abnormal temperature difference and extremely low temperatures can quickly trigger it, prompting fast corrective action by adjusting the valve opening.

Compliant with Milesight LoRaWAN[®] gateway and Milesight Development Platform solution, WT102 is able to work with the WT401 wireless thermostat to achieve remote linkage control.

The device has the following features:

- Built-in temperature sensor with support for external NTC sensor or WT401 wireless thermostat connection enables environmental detection and accurate control
- Intuitive, direction-adjustable LED display suitable for various installation environments
- Maintenance-free, self-powered by temperature difference with no battery replacement required
- Equipped with NFC for one touch configuration
- Up to 16 heating plans within one preset Date Period
- Supports open-window detection and freeze protection
- Supports the child lock function and anti-theft installation for safety reasons
- Stores historical records locally and support retransmission to prevent data loss
- Function well with standard LoRaWAN[®] gateways and network servers
- Compatible with BACnet system via Milesight LoRaWAN[®] gateways
- Compatible with Milesight Development Platform
- Supports multicast for control in bulk
- Support Firmware Update Over the Air (FUOTA) feature

Packing List

This section describes the packing list. After unboxing, please check that the following items are included in the package. If any of the below items are missing or damaged, please contact your sales representative.

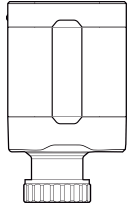

1 × Smart Radiator Thermostat



1 × Theft-detering Kit



1 × Warranty Card



1 × Quick Guide

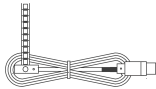

1 × USB-C NTC Sensor (Optional)

Hardware Introduction

Hardware Overview

Top View

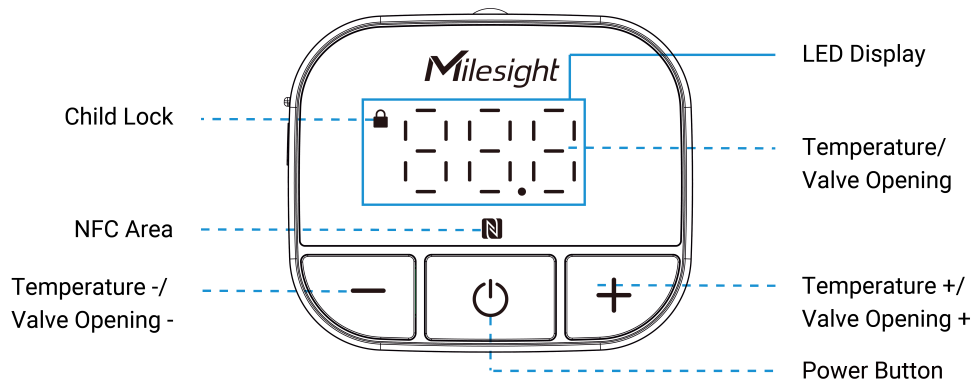

Part	Description
NFC Area	Enables power on/off and wireless configuration via Milesight ToolBox App.
LED Display	The display is normally off and can be activated by pressing any button once. Once activated, it displays the following information:

Part	Description
	<p>Ambient Temperature: Display normally or after pressing the power button once.</p> <p>Target Temperature: In Automatic Temperature Control mode or Integrated Control mode, press +/- button to display.</p> <p>Valve Opening: In Valve Opening Control mode, press +/- button to display.</p> <p>Child Lock: Display when the pressed button is locked.</p>
Power Button	Turn on/off or reset the device. For more details, see Power Button Description .
+/- Button	<p>Adjust the target temperature or target valve opening after the display lights up.</p> <p>In Automatic Temperature Control or Integrated Control mode, each press adjusts the target temperature by 0.5 or 1 (depends on the Target Temperature Resolution).</p> <p>In Valve Opening Control mode, each press adjusts the target valve opening by 5%.</p>

Left View

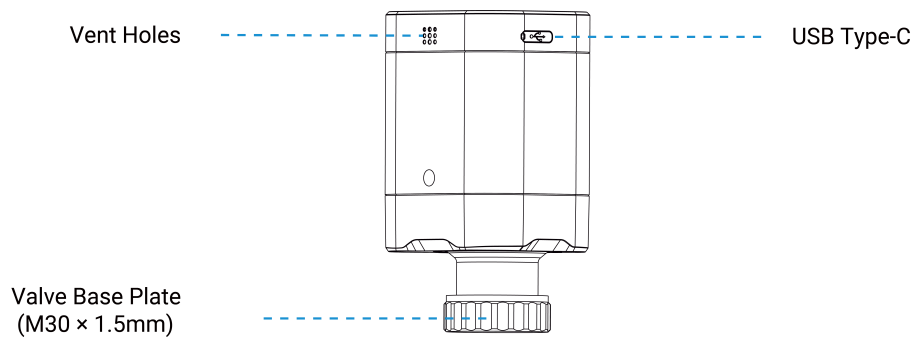

Part	Description
USB Type-C	Used for power supply, charging or USB-C NTC sensor connection. Remove the dust cap before use.
Vent Holes	Allow external air to flow into the holes to ensure the timely and accurate temperature measurement of the internal NTC sensor.

Part	Description
Valve Base Plate	Used to fix onto a valve with a thread size of M30 × 1.5 mm. For other valve types, it requires mounting metal valve adapters on the valve first.

Power Button and Display Descriptions

Function	Operation	LED Display
Power On	In an off state, press the power button for more than 3s.	Slowly Blinks
Power Off	In an on state, press the power button for more than 3s.	
Reset to Factory Default	Press and hold the power button for more than 10s.	Quickly Blinks
Motor Stroke Calibration	See Motor Stroke Calibration .	Success: Flashes in circle → Static on 3s
		Failure: Flashes in circle → Blinks twice

Dimensions

The following figure shows the device dimensions (unit: mm).

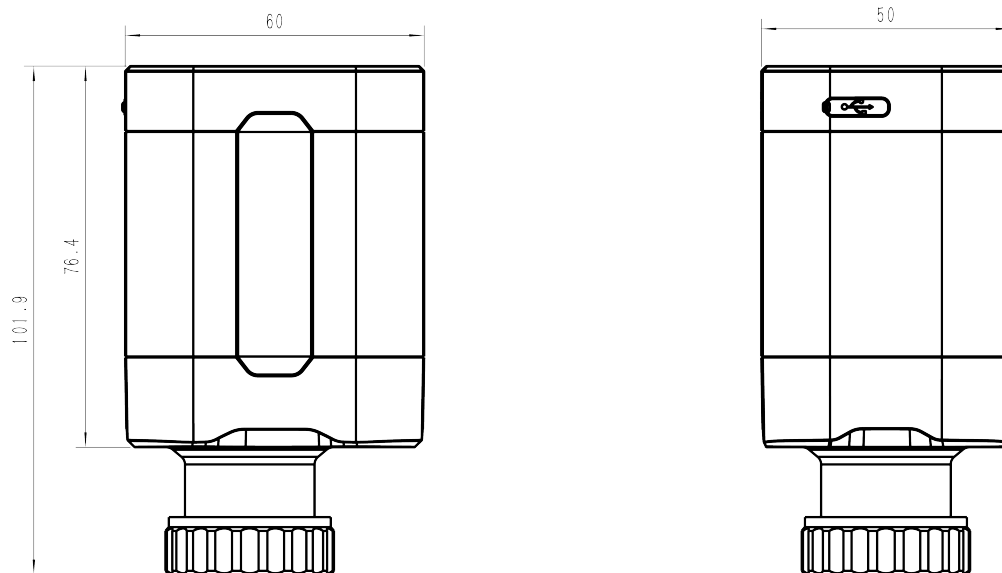

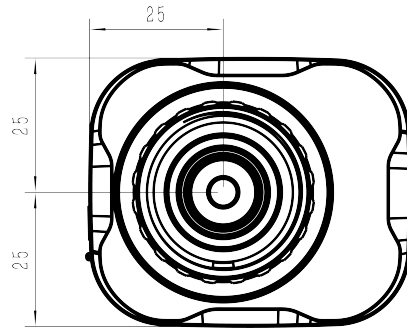

Chapter 3. Installation

This chapter describes how to install the device and accessories.

Install the Device

The device supports installing onto a valve with a thread size of M30 × 1.5 mm. For other valve types, it requires mounting **metal** valve adapters on the valve first.

Steps:

1. Place the base plate on the valve or valve adapter and fasten it tightly.

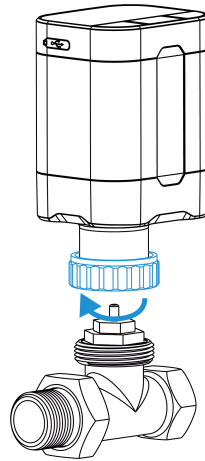

2. (Optional) Fix the theft-detering collar to the base plate with a screw and a nut.

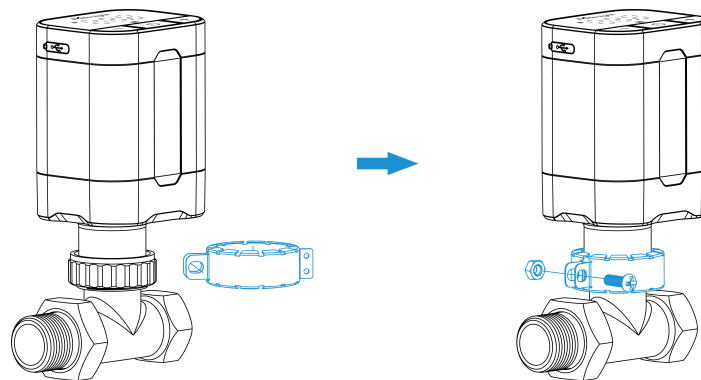

Install USB-C NTC Sensor (Optional)

WT102 has built in an internal temperature sensor to measure the environment temperature. It also supports connecting an external NTC temperature sensor via Type-C USB port to ensure precise control. During installation, ensure the temperature measurement component (marked blue in the following figure) is as far away from the radiator as possible to obtain accurate readings.

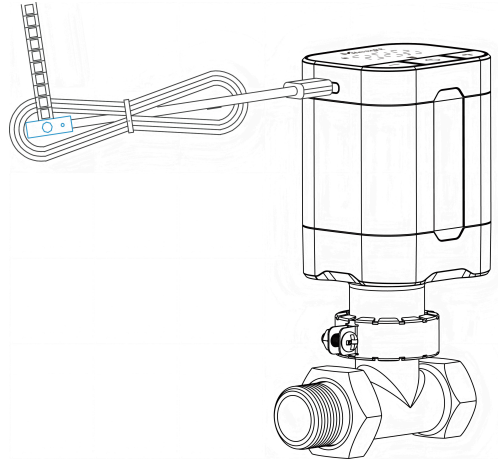

After installation, please change the ambient temperature source to USB-C NTC Sensor via [ToolBox App](#) or [downlink command](#).

Chapter 4. Power Supply

This section describes how to power and charge this device.

Energy Harvesting

The device supports self-powered based on thermal energy harvesting. When there is a temperature difference between the ambient temperature and the temperature inside the radiator, the device is able to convert this temperature difference into electrical voltage to charge and store energy.

The device's energy is measured by energy level. Here is the table to indicate the charge capability:

Ambient Temperature/°C	Temperature in the Radiator/°C	Difference/°C	Charge Level
20	40	20	3%/Per day
20	45	25	7%/Per day
20	60	40	12%/Per day

Emergency Charge

The device can also be powered or quickly charged directly by USB Type-C for short-term startup operations. Here is the table to indicate the charge capability:

Time	Charge Level
30 minutes	20%
6 hours 30 minutes	100%

Energy Level Indication

The device's energy level can be viewed via ToolBox App or uplink reports. It is recommended to check the energy level regularly to know the device's energy status and take measures to charge the device.

Status	Energy Level
Fully charged	100%
Report low energy alarm packet	< 15%
Power off automatically	0%
Power up after charging	17%

Status	Energy Level
Force heating start (if enabled)	< 10%
Force heating stop by adjusting temperature control targets	>20%
Force heating stop automatically	>27%

Chapter 5. ToolBox App Configuration

The Milesight ToolBox app can be used to configure the device. This chapter describes ToolBox related configuration.

Access the Device Using NFC

This section describes how to access the device using NFC.

Prerequisites: The device is powered by internal or external power source.

Steps:

1. Download Milesight ToolBox app from Google Play or Apple Store.
2. Enable the NFC function on the smart phone.
3. Launch ToolBox.

- a. Upon initial launch, the following page will appear. Select **NFC** and click **Enter**.

Select read method

Please select the default method to establish a connection with the device. This can be changed later through system settings.

N)) NFC	<input checked="" type="radio"/>
Bluetooth	<input type="radio"/>

Enter →

- b. Upon subsequent launches, Click **Maintenance** on the home page, and then select **NFC**.

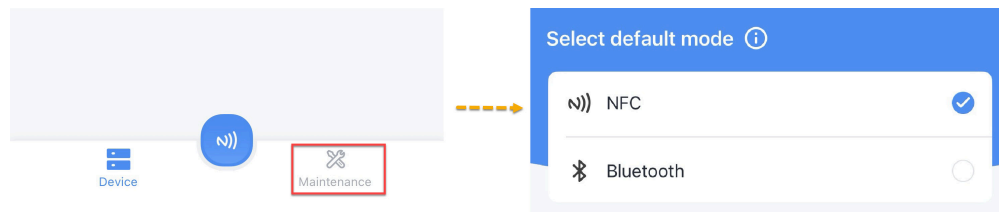



4. (Optional) To locate the NFC detection areas of the phone and the device, click **Can't find the NFC location**.
5. Put the NFC detection area of the phone close to the NFC antenna of the device.

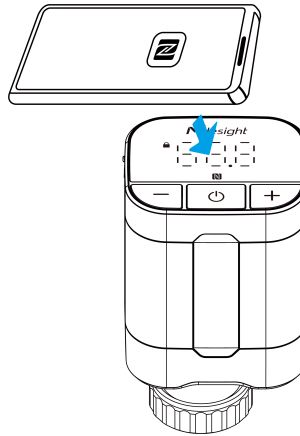

Tip:

- It is recommended to remove the phone case.
- The device cannot be read from or written to during motor stroke calibration.





6. Click . If the device is recognized successfully, the homepage is displayed.



Troubleshooting:

If read fails, move the phone away and reposition it close to the sensor to try again.

For a description of the homepage, refer to the following table.

Item	Description
Basic Information	Show basic device information and sync the device time.
Setting	Set the device and network parameters.
	Import, add, export or delete a template.
	Select language, show NFC positions, check App version, etc..

Synchronize Device Time

This section describes how to sync the device time.

Synchronize the Time Manually Through ToolBox App

The device time can be synced via Milesight ToolBox App.

Steps:

1. On the homepage of ToolBox, click **Basic Information**.
2. Click  to synchronize the time.



3. Put the NFC detection area of the phone close to the NFC antenna of the device. If the time is synchronized successfully, the following page is displayed.



Sync successfully!

Synchronize the Time Automatically Through a LoRaWAN[®] Network Server

Prerequisite: The LoRaWAN[®] network server supports the device time synchronization feature.

Steps:

1. Set the LoRaWAN[®] version of the device to **V1.0.3**. For details, refer to [Configure LoRaWAN[®] Parameters](#).
2. Connect the device to the network server. Once the device successfully joins the network, it sends a MAC command to query the time from the network server.



Note:

- This only supports getting the time, but not the time zone. The time zone can be configured by ToolBox App or downlink command.
- The device will send the DeviceTimeReq command every 5 days since the last sync.

Configure LoRaWAN® Parameters

This section describes how to configure the device transmission parameters for the LoRaWAN® network.

Usually, it consists of the below steps:

1. [Configure Join Type and Supported Frequency \(Necessary\)](#)
2. [Configure Other LoRaWAN® Parameters \(Optional\)](#)
3. [Configure Multicast Group \(Optional\)](#)

Configure Join Type and Frequency

It is necessary to configure the join type and the frequency to establish communication with LoRaWAN® gateways.

Steps:

1. On the homepage of ToolBox, click **Setting** to enter the **Setting** page.
2. Navigate to the **LoRaWAN** page The **LoRaWAN** page is displayed, see the following figure.

The screenshot shows the 'LoRaWAN' configuration page. The fields are as follows:

- Device EUI:** 24E124...
- * APP EUI:** 24e124c0002a0001
- * Application Port:** 85
- LoRaWAN Version:** V1.0.3
- Work Mode:** (Dropdown menu with a help icon)

3. From the **Join Type** selection box, select **OTAA** or **ABP** as needed.

**Note:**

OTAA is required if you connect the device to the [Milesight Development Platform](#).

4. Configure **Join Type** related parameters as needed. You can use default values unless otherwise specified.
- If **OTAA** is selected, configure **Application Key** and **Rejoin Mode** as needed. For details, refer to the following table.

Parameter	Description
Application Key	<p>Appkey for OTAA mode. Default: Device EUI + Device EUI. Example: 24e124123456789024e1241234567890.</p> <div style="border: 1px solid #ccc; background-color: #e6f2ff; padding: 5px; margin-top: 10px;"> <p> Tip: Contact sales before purchase if you need random App keys.</p> </div>
Rejoin Mode	<p>Rejoin mode for OTAA mode.</p> <p>Reporting interval ≤ 35 minutes: The device sends a specific number of LinkCheckReq MAC packets at each reporting interval or every other reporting interval to verify connectivity.</p> <p>Reporting interval > 35 minutes: The device sends a specific number of LinkCheckReq MAC packets at each reporting interval to validate connectivity. If there is no response, the device will re-join the network.</p> <p>When Rejoin Mode is enabled, enter a number in the Set the number of detection signals sent text box. The actual sending number is the configured number +1.</p>

- If **ABP** is selected, configure **Network Session Key**, **Application Session Key** and **Device Address** as needed. For details, refer to the following table.

Parameter	Description
Network Session Key	<p>Nwkskey for ABP mode. Default: 5572404C696E6B4C6F52613230313823.</p>

Parameter	Description
Application Session Key	Appskey for ABP mode. Default: 5572404C696E6B4C6F52613230313823.
Device Address	DevAddr for ABP mode. Default: 5 th to 12 th digits of SN.

5. Select a frequency from the **Support Frequency** selection box as needed. This must be the same as the frequency configured on the gateway's web GUI.
6. Click **Write** in the lower right corner, and put the NFC detection area of the phone close to the NFC antenna of device. If the configuration succeeds, the following page is displayed.



Write successfully!

Configure Other LoRaWAN[®] Parameters

Steps:

1. On the homepage of ToolBox, click **Setting** to enter the **Setting** page.
2. Navigate to the **LoRaWAN** page The **LoRaWAN** page is displayed, see the following figure.

LoRaWAN

Device EUI

24E124

* APP EUI

24e124c0002a0001

* Application Port

85

LoRaWAN Version

V1.0.3

Work Mode ⓘ

3. Configure the following parameter as needed. You can use default values unless otherwise specified. For a description of the parameters, refer to the following table.

Parameter	Description
Device EUI	<p>Unique ID of the device labelled on the device housing.</p> <p>i Tip: For bulk deployments, contact sales to request the device EUI list.</p>
App EUI	The default App EUI (join EUI) is 24E124C0002A0001.
Application Port	Port used for sending and receiving data. Default: 85 .
LoRaWAN [®] Version	Options: V1.0.2 , V1.0.3 .
Work Mode	Class A or Class B is optional. During the non-heating period, it is fixed in Class A mode.
Confirmed Mode	If the device does not receive ACK packet from network server, it will re-send data once.
Join Type	Refer to Configure Join Type and Supported Frequency .

Parameter	Description
Supported Frequency	Refer to Configure Join Type and Supported Frequency .
ADR Mode	Enables the network server to adjust the spreading factor, the bandwidth and the transmission power to optimize data rates, airtime and energy consumption in the network.
Spreading Factor	If ADR mode is disabled, the device sends uplink data using this spreading factor. A higher spreading factor increases transmission range but reduces data rate and increases power consumption. This parameter varies with Supported Frequency .
Tx Power	Defined by the LoRa Alliance. Specifies the strength of the radio signal transmitted by the device.
RX2 Data Rate	RX2 data rate to receive downlinks.
RX2 Frequency	RX2 frequency to receive downlinks. Unit: Hz
Ping Slot Periodicity	The period to open the ping slot to receive messages when work mode is Class B. Default: 32. <div style="background-color: #e0f2f1; padding: 5px; border-radius: 5px;"> <p> Tip: The smaller the value, the greater the power consumption.</p> </div>
Multicast Group	Enable or disable multicast groups. For more details, see Configure Multicast Group .

- Click **Write** in the lower right corner, and put the NFC detection area of the phone close to the NFC antenna of device. If the configuration succeeds, the following page is displayed.



Write successfully!

Configure Multicast Group

The device supports setting up multiple multicast groups to receive multicast commands from the network server, allowing users to control devices in bulk.

Prerequisites: The work mode of the device is **Class B**.

Step 1. Enable Multicast Group on the Device

1. On the homepage of ToolBox, click **Setting** to enter the **Setting** page.
2. On the top bar, select **Network** tab.

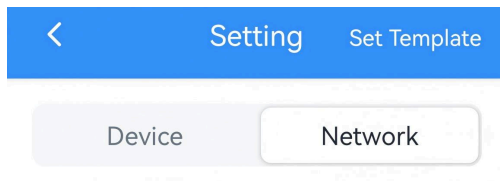

3. In the **LoRaWAN** page, ensure the **Application Port** of each device is the same.
4. Enable a **Multicast Group**, and configure the following parameter as needed. You can use default values unless otherwise specified. For a description of the parameters, refer to the following table.

Parameter	Description
Multicast Address	Unique 8-digit address to distinguish multicast groups.
McNetSKey	32-digit key. Default values: - Multicast Group 1: 5572404C696E6B4C6F52613230313823 - Multicast Group 2: 5572404C696E6B4C6F52613230313824 - Multicast Group 3: 5572404C696E6B4C6F52613230313825 - Multicast Group 4: 5572404C696E6B4C6F52613230313826
McAppSKey	32-digit key. Default values: - Multicast Group 1: 5572404C696E6B4C6F52613230313823 - Multicast Group 2: 5572404C696E6B4C6F52613230313824 - Multicast Group 3: 5572404C696E6B4C6F52613230313825 - Multicast Group 4: 5572404C696E6B4C6F52613230313826
Multicast Ping Slot Periodicity/s	The period to open the ping slot to receive multicast commands.

Parameter	Description
Multicast Data Rate	The data rate to receive multicast commands.
Multicast Frequency	The frequency to receive multicast commands. Unit: Hz

- (Optional) To enable another multicast group, follow the above step to configure the corresponding group.
- Click **Write** in the lower right corner, and put the NFC detection area of the phone close to the NFC antenna of device. If the configuration succeeds, the following page is displayed.



Write successfully!

Step 2. Add a Multicast Group on the Network Server

The following steps use a Milesight gateway as an example. For other network servers, please refer to corresponding guides.

- Ensure the target devices are added to this gateway and have joined to the network.
- On the gateway web GUI, navigate to **Network Server > Multicast Groups** page.

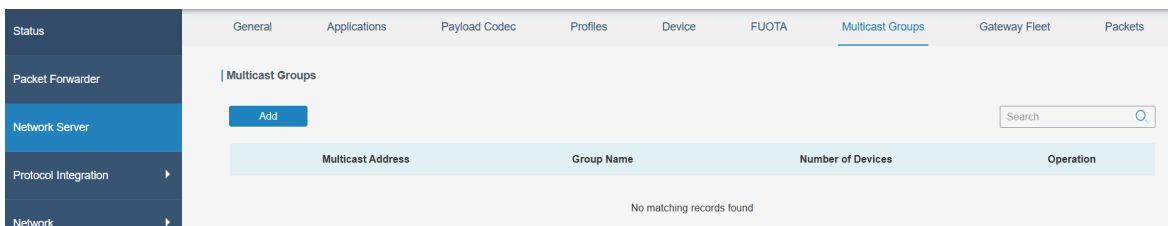

- Click **Add** to add a multicast group.
- Configure the multicast group parameters to match those configured on ToolBox and select the devices that you need to control.

Group Name	Device Control
Multicast Address	11111111
Multicast Network Session Key	5572404C696E6B4C6F526132
Multicast Application Session Key	5572404C696E6B4C6F526132
Class Type	Class B
Datarate	DR3 (SF9, 125kHz)
Frequency	869525000 Hz
Frame-counter	0
Ping Slot Periodicity	Every 4 second
Selected Devices	
device1 x device2 x	

5. Click **Save** to save this multicast group.
6. Click **Packets** tab in the upper right corner.
7. In the **Send Data to Multicast Group** section, select the multicast group from the **Multicast Groups** drop-down list and configure the downlink command parameters.
8. Click **Send**. The network server broadcasts the command to all devices in this multicast group.

The screenshot shows the 'Send Data to Multicast Group' configuration interface. The interface is divided into two main sections: 'Send Data to Device' and 'Send Data to Multicast Group'. The 'Send Data to Multicast Group' section is highlighted with a red box. It contains the following fields and controls:

- Multicast Group:** A dropdown menu with 'Device Control' selected.
- Type:** A dropdown menu with 'hex' selected.
- Payload:** A text input field containing 'ff10ff'.
- Port:** A text input field containing '85'.
- Send:** A blue button to execute the command.

Configure the Device Parameters

This section describes how to configure the device.

Change the Device Password

It is recommended to change the device password upon initial configuration for security purposes. This section describes how to change the device password.

Steps:

1. On the homepage of ToolBox, click **Setting** to enter the **Setting** page.
2. On the top bar, select **Device** tab.

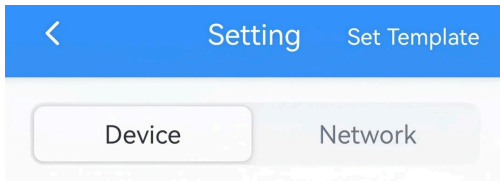

3. In the **General** page, enable **Change Password** and enter the new password.

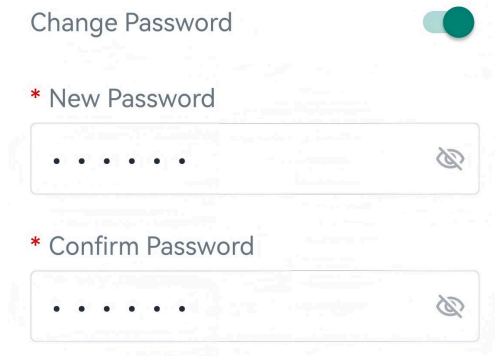

Parameter	Description
New Password	Enter a new password of 6 characters. Only letters, digits, and underscores are allowed.
Confirm Password	Enter the password again.

4. Click **Write** in the lower right corner, and put the NFC detection area of the phone close to the NFC antenna of device. If the password was changed successfully, the following page is displayed.



Write successfully!

Configure General Parameters

This section describes how to configure the general parameters of the device, which includes:

- Temperature Unit
- Ambient Temperature Source
- Ambient Temperature Display
- Heating Date
- Reporting Interval
- Non-heating period valve status
- Child Locks
- Time Zone
- Daylight Saving Time
- Device password

Steps:

1. On the homepage of ToolBox, click **Setting** to enter the **Setting** page.
2. On the top bar, select **Device** tab.

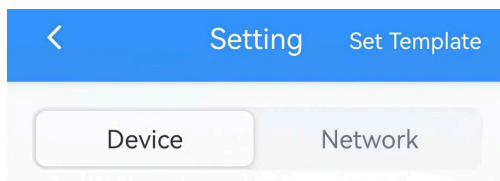

3. In the **General** page, configure the following device parameters as needed.

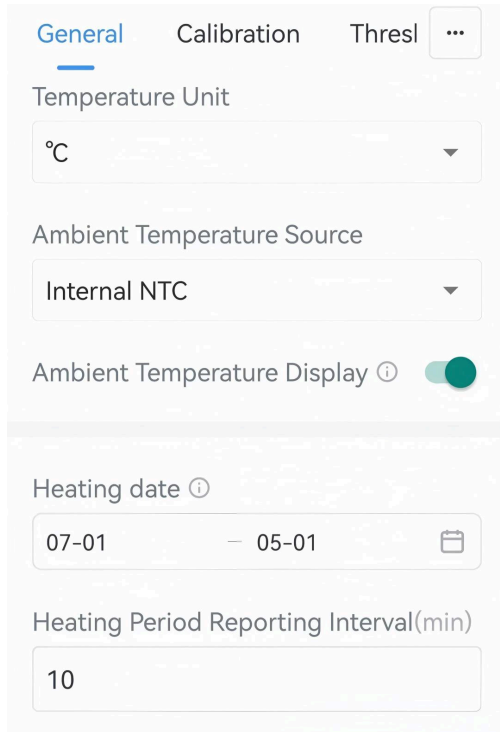

Parameter	Description
Temperature Unit	<p>Select the temperature unit displayed on the ToolBox and the LCD display.</p> <div style="background-color: #e6f2ff; padding: 10px; border-radius: 5px;"> <p> Note:</p> <ul style="list-style-type: none"> ◦ The temperature unit in the uplink reports is fixed as Celsius(°C). ◦ Please modify the threshold settings if the unit is changed. </div>
Ambient Temperature Source	<p>Select the source of the ambient temperature.</p> <p>Internal NTC: Use internal NTC sensor.</p> <p>USB-C NTC: Use external USB-C NTC sensor. This requires installing the USB-C NTC sensor.</p> <p>LoRa Downlink: Receive temperature data from network server.</p>
Ambient Temperature Display	<p>Enable or disable to display ambient temperature after pressing any button. If disabled, the ambient temperature will be replaced by target temperature or valve opening.</p>

Parameter	Description
Heating Date	Set the heating period to control the temperature. The temperature control will stop during the non-heating period.
Heating Period Reporting Interval	The interval to report data to network server during the heating period. Range: 5~1440 min, Default: 10 min.
Non-heating Period Reporting Interval	The interval to report data to network server during the non-heating period. Range: 5~1440 min, Default: 1440 min.
Non-heating Period Valve Status	Select the valve status as Fully open or Fully close during the non-heating period.
Temperature Control	Enable or disable temperature control. For details, refer to Configure Temperature Control Parameters .
Open Window Detection	Enable or disable open window detection. For details, refer to Configure Temperature Control Parameters .
Freeze Protection	Enable or disable freeze protection. For details, refer to Configure Temperature Control Parameters .
Force Heating	Enable or disable force heating. For details, refer to Configure Temperature Control Parameters .
Child Locks	Once enabled, the corresponding button's feature will be disabled. Options: System On/Off and Temperature +/- .
Time Zone	Select the UTC time zone. When you click Sync button of ToolBox App to sync time, the device will also sync the time zone from smart phone automatically.
Daylight Saving Time	Enable or disable Daylight Saving Time (DST). Start Time: The start time of DST time range. End Time: The end time of DST time range. DST Bias: The DST time will be faster according to this bias.
Data Storage	Disables or enables data storage. For details, refer to Configure the Data Storage&Retransmission .
Data Retransmission	Disables or enables data retransmission. For details, refer to Configure the Data Storage&Retransmission .
Device password	Change the password for ToolBox App to write this device.

- Click **Write** in the lower right corner, and put the NFC detection area of the phone close to the NFC antenna of device. If the configuration succeeds, the following page is displayed.



Write successfully!

Related information

[Commands for General Setting](#)

Configure Temperature Control Parameters

This section describes how to configure the temperature control related parameters of the device, which includes:

- Temperature Control
- Open Window Detection
- Freeze Protection
- Force Heating

Configure Temperature Control Parameters

The device supports controlling the temperature during the heating period.

Prerequisites: [Motor Stroke Calibration](#) is successful.

Steps:

- On the homepage of ToolBox, click **Setting** to enter the **Setting** page.
- On the top bar, select **Device** tab.

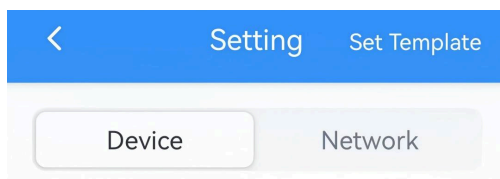

3. In the **General** page, enable **Temperature Control**.

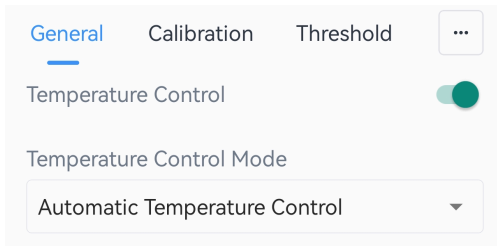

4. Select the **Temperature Control Mode** and configure the related parameters.

- **Automatic Temperature Control:** Automatically adjust to the target temperature via the device's algorithm.

Parameter	Description
Target Temperature Resolution	Select the resolution of the target temperature. Options: 0.5: Increase or decrease target temperature by 0.5 each time. 1: Increase or decrease target temperature by 1 each time.
Target Temperature	Set the target temperature for device control. Range: 5~35 °C/41~95 °F.
Target Temperature Regulation Range	Set the range to adjust target temperature. Range: 5~35 °C/41~95 °F.

- **Valve Opening Control:** Adjust the valve opening status directly to control the temperature.

Parameter	Description
Valve Opening	Set the valve opening percentage. 0% means fully closed and 100% means fully open.

- **Integrated Control:** Automatically adjust to target temperature via the device's algorithm, and support receiving valve opening downlink control commands.

Parameter	Description
Target Temperature Resolution	Select the resolution of the target temperature. Options: 0.5: Increase or decrease target temperature by 0.5 each time. 1: Increase or decrease target temperature by 1 each time.

Parameter	Description
Target Temperature	Set the target temperature for device control. Range: 5~35 °C/41~95 °F.
Target Temperature Regulation Range	Set the range to adjust target temperature. Range: 5~35 °C/41~95 °F.

5. Click **Write** in the lower right corner, and put the NFC detection area of the phone close to the NFC antenna of device. If the configuration succeeds, the following page is displayed.



Write successfully!

Result

During the heating period and not executing any schedule event, the device will control the temperature according to the above settings.

Configure Open Window Detection Parameters

The device supports detecting the window open status to stop invalid temperature control, thus saving energy. The following steps enable automatic detection of the window open status. In addition, the device supports manual control of the window open status via [downlink commands](#).

Prerequisites: Temperature Control is enabled.

Steps:

1. On the homepage of ToolBox, click **Setting** to enter the **Setting** page.
2. On the top bar, select **Device** tab.

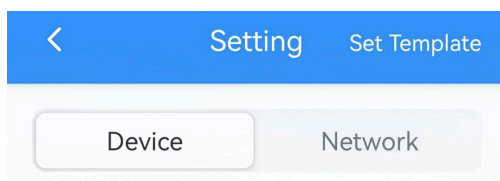

3. In the **General** page, enable **Open Window Detection** and configure the related parameters. The following page is displayed.

The screenshot shows the 'General' configuration page with the following settings:

- Open Window Detection:** Enabled (toggle switch is green).
- Cooling Rate (°C / min):** Set to 3, with a comparison operator of \geq .
- Valve Status:** Set to 'Remains unchanged'.
- Stop temperature control for (min):** Set to 30.

Parameter	Description
Cooling Rate	Set the dropping ambient temperature per minute. When the rate reaches the preset value, it is considered a window-open status. Range: 2~10 °C/35.6~50 °F.
Valve Status	Select the valve status during the window-open status. Options: Remains unchanged, Close Valve.
Stop temperature control for	The interval to stop temperature control after detecting a window-open status. If the window-open status is not released within this interval, the device will re-detect the window-open status. Range: 1~1440 min, Default: 30 min.

- Click **Write** in the lower right corner, and put the NFC detection area of the phone close to the NFC antenna of device. If the configuration succeeds, the following page is displayed.



Write successfully!

Result

When the device detects that the cooling rate reaches the preset value, it sends an open window alarm packet and stops temperature control.

When the device detects that the ambient temperature continues to rise for over 10 minutes during **Stop temperature control interval**, it sends an open window alarm release packet and resumes temperature control.

Configure Freeze Protection Parameters

The device supports opening the valve to avoid freezing when detecting that the ambient temperature is too low.

Prerequisites: **Temperature Control** is enabled.

Steps:

- On the homepage of ToolBox, click **Setting** to enter the **Setting** page.
- On the top bar, select **Device** tab.

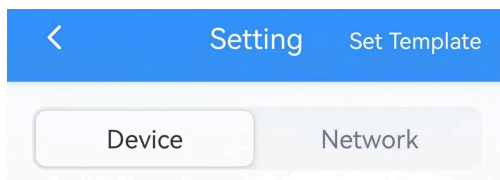

- In the **General** page, enable **Freeze Protection** and configure the **Freeze Protection Temperature**. The following page is displayed.

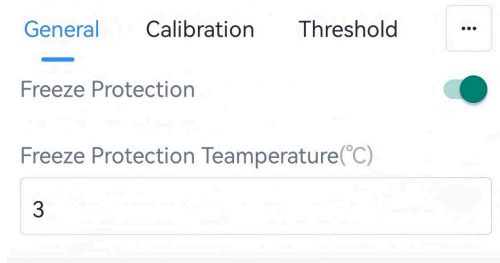

4. Click **Write** in the lower right corner, and put the NFC detection area of the phone close to the NFC antenna of device. If the configuration succeeds, the following page is displayed.



Write successfully!

Result

When the device detects that the ambient temperature is lower than freeze protection temperature, it sends a freeze protection trigger packet and starts temperature control.

When the device detects that the ambient temperature is higher than freeze protection temperature for over 2 hours, it sends a freeze protection release packet and keeps current valve opening status.

Configure Force Heating Parameters

When the device's energy is insufficient, it supports forcing valves to open for heating to create a temperature difference for charging. During force heating, temperature collection, temperature control, and uplink/downlink are all not working.

Prerequisites: **Temperature Control** is enabled.

Steps:

1. On the homepage of ToolBox, click **Setting** to enter the **Setting** page.
2. On the top bar, select **Device** tab.

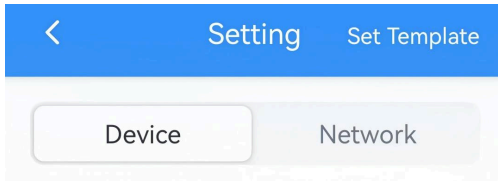

3. In the **General** page, enable **Force Heating**. The following page is displayed.

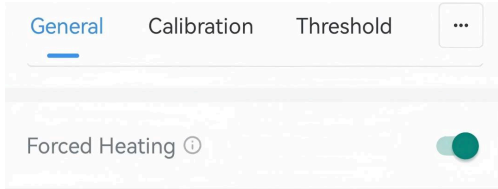

4. Click **Write** in the lower right corner, and put the NFC detection area of the phone close to the NFC antenna of device. If the configuration succeeds, the following page is displayed.



Write successfully!

Result

When the energy level falls below 10%, the device sends a force heating start packet and start force heating by making sure the valve opening not lower than 50%.

When the energy level is over 20%, the device restores temperature collection and uplink/downlink features. During this time, it supports exiting force heating by adjusting target temperature/valve opening/schedule event.

When the energy level is over 27% or is powered by the USB port, the device sends a force heating exit packet and returns to normal working status.

Related information

[Commands for Temperature Control Settings](#)

[Alarm Report](#)

Configure Data Storage & Retransmission

The device supports data storage and data retransmission to ensure data integrity. This section describes how to configure data storage and data retransmission.

Export the Local Data

The device supports storing historical data records locally, which operates normally even when the network is deactivated.

Each device can store up to 1,000 data records.

Prerequisites: [Sync the time](#) to ensure the data is stored in correct time.

Steps:

1. On the homepage of ToolBox, click **Setting** to enter the **Setting** page.
2. On the top bar, select **Device** tab.

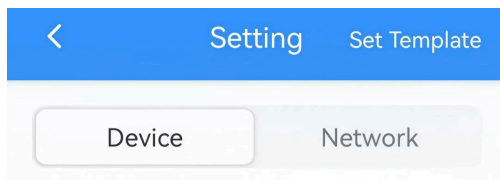

3. In the **General** page, enable **Data Storage**.
4. Return to the homepage and click **Maintenance** in the lower right corner.
5. Click **History Data**, select the data time range and click **Export** to read data.



Tip:

- Since the ToolBox App's data export time range is limited to 14 days, you can export the complete data in segments if the required time range exceeds this limit.
- Click  in the top right to check the history export records.

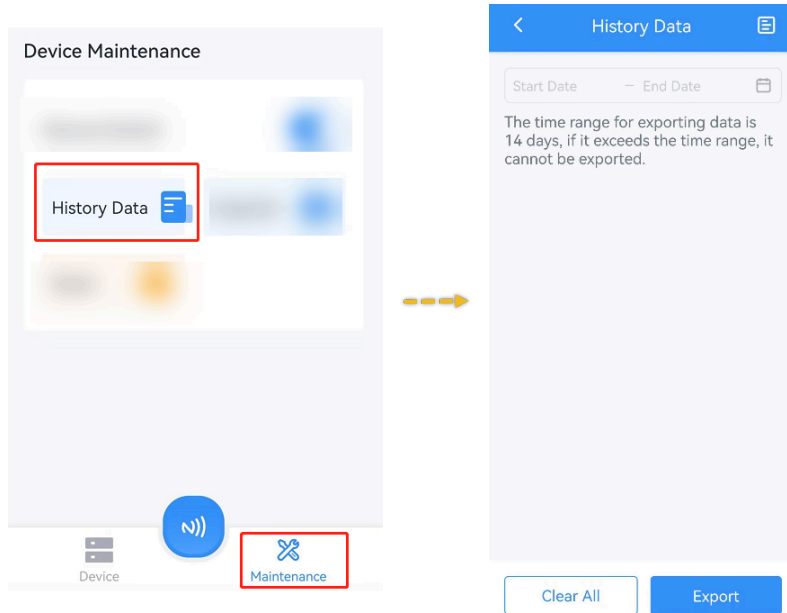

6. Put the NFC detection area of the phone close to the NFC antenna of device. If the read succeeds, the history data will display.
7. Click **Export** to customize a file name, then click **OK** to save the history data as a CSV file to your smartphone.

Enable Data Retransmission

Data retransmission allows the network server to receive data, even after temporary network outages.

Prerequisites: The device join type is **OTAA**.

Steps:

1. On the homepage of ToolBox, click **Setting** to enter the **Setting** page.
2. On the top bar, select **Network** tab.

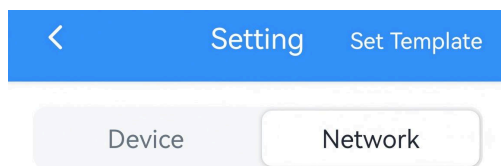

3. In the **LoRaWAN** page, enable **Rejoin Mode** and set the number of packets sent.

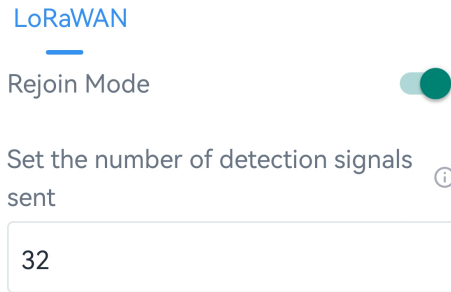

4. On the top bar, select **Device** tab.

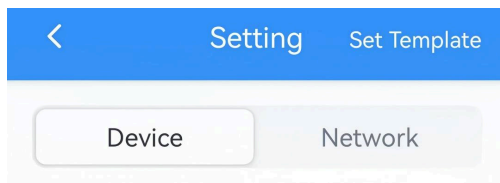

5. In the **General** page, enable **Data Storage** and **Data Retransmission**.

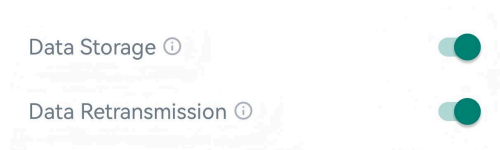

6. Click **Write** in the lower right corner, and put the NFC detection area of the phone close to the NFC antenna of device. If the configuration succeeds, the following page is displayed.



Write successfully!

Result:

When the device detects the network status is deactivated via rejoin mode mechanism, the device will record a data lost time point and re-transmit the lost data according to data retransmission interval after device re-connects to the network. The reported format of retransmission data will include timestamps and is different from periodic report data.

**Note:**

- Data retransmission increases the uplink traffic and consume device energy quickly.
- If the device reboots or re-power during data retransmission, it will resend the entire retransmission dataset after reconnecting to the network.
- If a new network disconnection occurs during an ongoing retransmission, only the data logged during this latest outage will be sent upon reconnection.
- The default report data retransmission interval is 600s, this can be changed via downlink command.

Query Historical Data

The device supports data retrievability feature to query historical data for a specific time range via downlink command. The retransmission data format includes timestamps and differs from the periodic report format. For details, refer to [Commands for Historical Data Query](#).

Related information

[Commands for General Setting](#)

Configure Calibration Parameters

This section describes how to configure the calibration parameters.

Motor Stroke Calibration

Motor stroke calibration must be performed to ensure temperature control. Usually, the device will automatically perform a stroke calibration under the following cases:

- The device is powered on, restarted, or reset;
- Temperature Control is re-enabled;
- From the non-heating period to the heating period;
- For a non-calibrated device, press any button, change target temperature or valve opening, or execute the heating event.

After calibration, the device will return the result by ToolBox App, [LED display](#) and [Motor Stroke Calibration Packet](#).

If calibration still fails, please follow the steps for manual calibration.

Steps:

1. On the homepage of ToolBox, click **Setting** to enter the **Setting** page.
2. On the top bar, select **Device** tab.

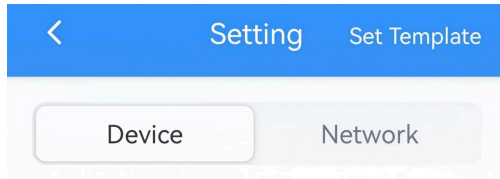

3. In the **Calibration** page, click **Stroke Calibration**.

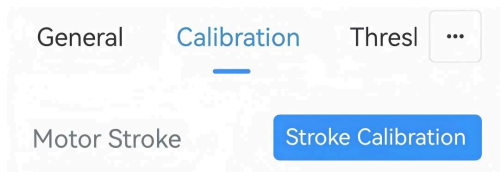

4. Put the NFC detection area of the phone close to the NFC antenna of device. If the configuration succeeds, the device will start calibrating once.

Effective Stroke

The effective stroke feature allows for limiting the maximum valve opening to control the maximum heat dissipation (hot water amount) of the radiator and achieve hydraulic balancing.

Steps:

1. On the homepage of ToolBox, click **Setting** to enter the **Setting** page.
2. On the top bar, select **Device** tab.

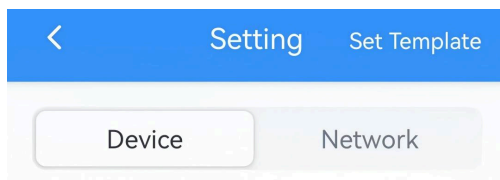

3. In the **Calibration** page, configure the maximum valve opening percentage.

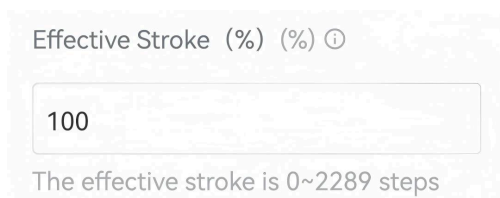

4. Click **Write** in the lower right corner, and put the NFC detection area of the phone close to the NFC antenna of device. If the configuration succeeds, the following page is displayed.



Write successfully!

Temperature Calibration

The device supports adding calibration values to the current temperature values, then display and report the final values.

Prerequisites: Ambient temperature source is **Internal NTC**.

Steps:

1. On the homepage of ToolBox, click **Setting** to enter the **Setting** page.
2. On the top bar, select **Device** tab.

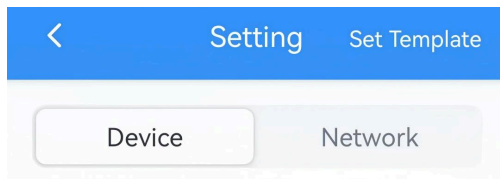

3. In the **Calibration** page, enable **Temperature** and enter a **Calibration Value**. The following page is displayed.

Temperature

Current Value(°C) **23**

Final Value(°C) **22.5**

Calibration Value(°C) -0.5

4. Click **Write** in the lower right corner, and put the NFC detection area of the phone close to the NFC antenna of device. If the configuration succeeds, the following page is displayed.



Write successfully!

Related information

[Motor Stroke Calibration Packet](#)

[Commands for Calibration Settings](#)

Configure Temperature Threshold Parameters

This section describes how to configure temperature threshold parameters.

Steps:

1. On the homepage of ToolBox, click **Setting** to enter the **Setting** page.
2. On the top bar, select **Device** tab.

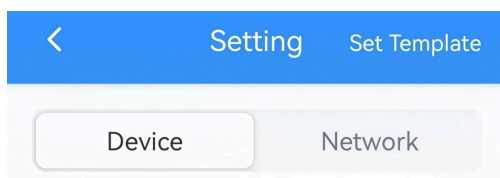

3. In the **Threshold** page, enable **Temperature** and enter at least one threshold value. The following page is displayed.

4. Click **Write** in the lower right corner, and put the NFC detection area of the phone close to the NFC antenna of device. If the configuration succeeds, the following page is displayed.



Write successfully!

Result:

Above Threshold: When the ambient temperature exceeds the Above threshold value, the device immediately sends a threshold alarm packet; when the ambient temperature falls to the Above threshold value minus 1, the device sends an alarm release packet.

Below Threshold: When the ambient temperature falls below the Below threshold value, the device immediately sends a threshold alarm packet; when the ambient temperature exceeds the Below threshold value plus 1, the device sends an alarm release packet.

Related information

[Command for Threshold Setting](#)

[Alarm Report](#)

Configure Schedule Parameters

This section describes how to add and manage schedule events to achieve the automatic temperature control during heating period.

Prerequisites: [Sync the time](#) to ensure the schedule is executed in correct time.

Steps:

1. On the homepage of ToolBox, click **Setting** to enter the **Setting** page.
2. On the top bar, select **Device** tab.

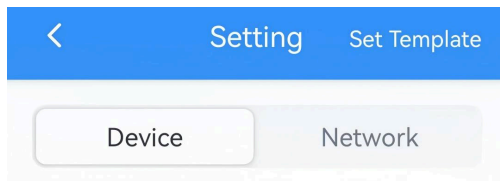

3. In the **Schedule** page, click **Add New Schedule** to add a schedule event. Each device supports up to 16 events.

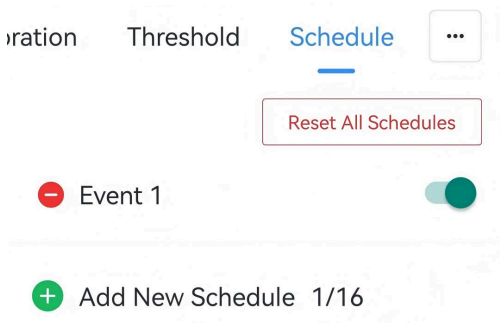

4. Configure the related parameters of this schedule event.

<
Event1

Schedule Time

00:00
🕒

Schedule Repeat Day

Mon., Tues.
▼

Temperature Control Mode

Automatic Temperature Co...
▼

Target Temperature(°C)

20

Reporting Interval(min)

10

Parameter	Description
Schedule Time	The time to execute this schedule event during heating period.
Schedule Repeat Day	Select the weekdays to execute this schedule event every week. If left blank, the schedule event will only execute once.
Temperature Control Mode	Select the temperature control mode.
Target Temperature	When temperature control mode is Automatic Temperature Control or Integrated Control, set the target temperature. Range: 5~35 °C/41~95 °F.
Valve Opening	When temperature control mode is Valve Opening Control, set the target valve opening percentage. Range: 0-100%.
Reporting Interval	The interval to report data to network server when executing the schedule event. Range: 5~1440 min.

5. Click **Confirm** to save this schedule event.
6. Enable or disable to execute the schedule event.

7. (Optional) Click  to delete a schedule event, or click **Reset All Schedules** to restore factory settings as required.
8. Click **Write** in the lower right corner, and put the NFC detection area of the phone close to the NFC antenna of device. If the configuration succeeds, the following page is displayed.



Write successfully!

Related information

[Commands for Schedule Settings](#)

Maintain the Device

This section describes how to maintain the device.

Upgrade the Device

The device supports local upgrade via ToolBox App or FUOTA via remote LoRaWAN® network servers. For the details of FUOTA, please refer to corresponding server guides. This section describes how to upgrade the device locally.

Prerequisites: Download firmware from [Milesight official website](#) and save it to the smart phone. It is recommended to consult technical support before upgrading to ensure a safe and successful upgrade.

Steps:

1. On the homepage of ToolBox, click **Maintenance** in the lower right corner.
2. Click **Upgrade** to go to **Upgrade** page.
3. Click **Upload** to select the firmware from the local path of the smartphone.
4. Click **Upgrade** to upgrade the device.

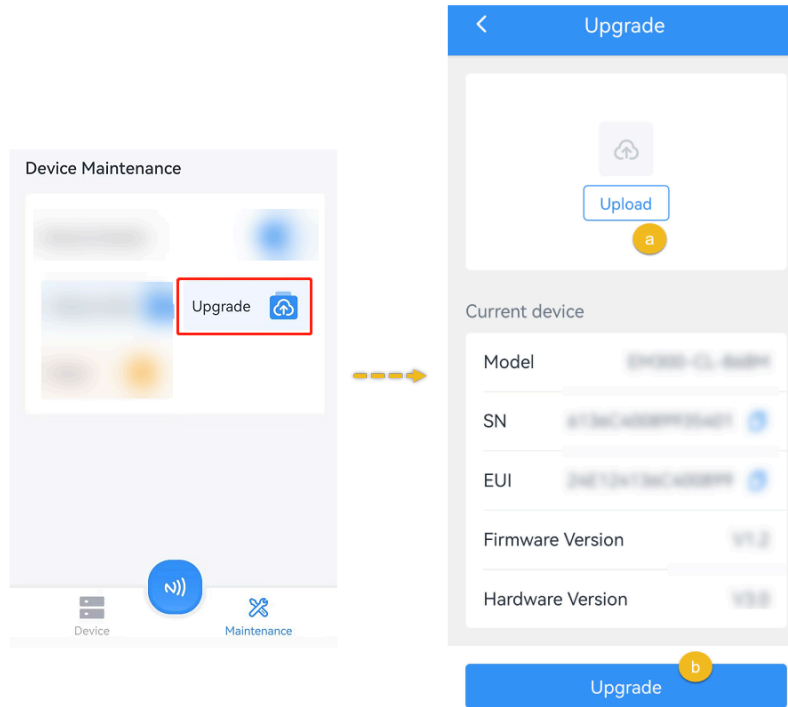

- Put the NFC detection area of the phone close to the NFC antenna of device for a few minutes.



CAUTION:

Any operation on ToolBox is not allowed during upgrading, otherwise the upgrading will be interrupted, or even the device will break down.

Configure a Template for Configuration Backup

This device supports configuration backup, which enables quick and easy batch configuration. This section describes how to backup the device configuration and write to other devices.

Prerequisites: The backup device and the device importing the backup are exactly the same model.

Step 1. Set a Template

- Access the device via ToolBox App.
- On the homepage of ToolBox, click **Setting** to enter the **Setting** page.
- Edit the device parameters as required, click **Set Template** in the top right corner.
- Customize a template name, click **Confirm** to save the current configuration as a template.

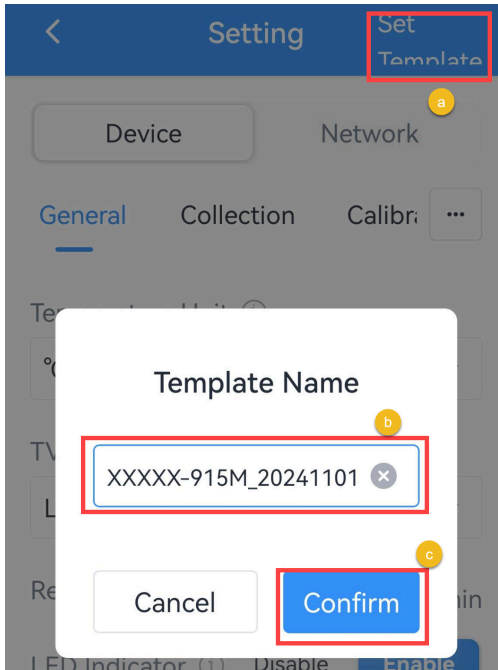

5. If the save is successful, the following page is displayed. The template will be saved to the ToolBox App.

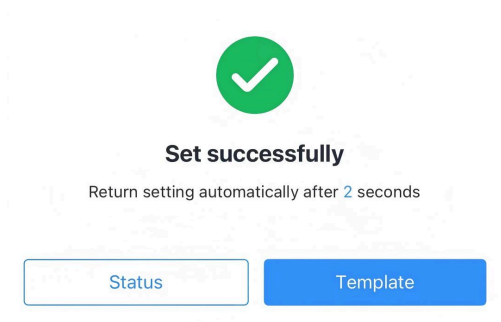

Step 2. Write Template Configuration to the Target Device

1. On the homepage of ToolBox, click **Device** in the lower left corner.
2. Click Template icon in the top right corner to go to **Template** page.



3. Click the saved template. Do not select the template.

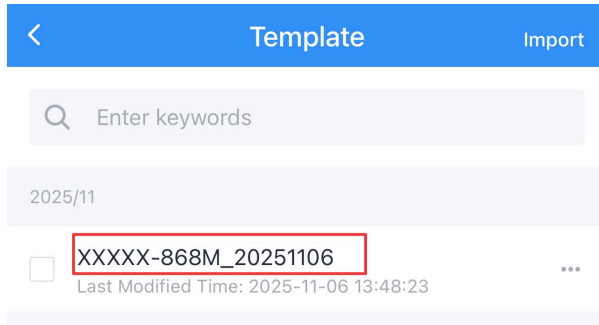

4. In the displayed page, click **Write** in the bottom and put the NFC detection area of the phone close to the NFC antenna of the target device. If the configuration is written to the target device, the following page is displayed.



Write successfully!

Step 3. Export or Delete a Template (Optional)

1. Select the checkbox of the target template as shown in the following figure.

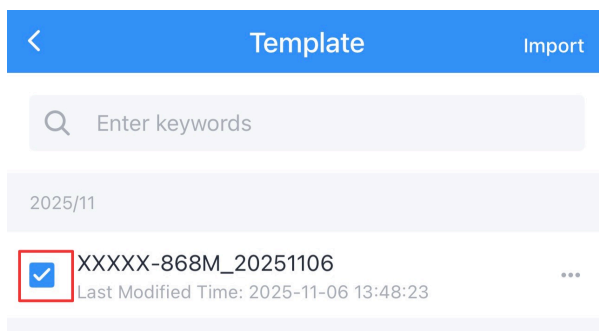

2. Click **Export** in the lower left corner to export this template as a JSON format file and save it to the smart phone.
3. Click **Delete** in the lower right corner, then click **Confirm** to delete this template from ToolBox.

Reset the Device

This section describes how to reset the device.

Steps:

1. On the homepage of ToolBox, click **Maintenance** in the lower right corner. The **Maintenance** page is displayed, see the following figure.

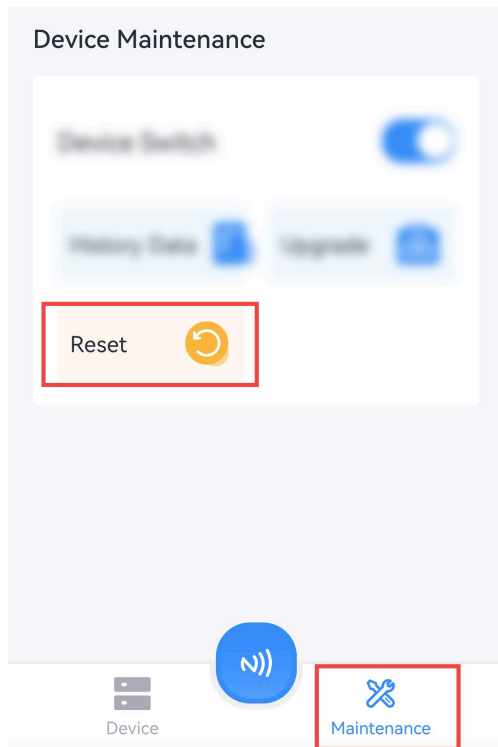

2. Click **Reset**.
3. In the displayed dialog box, click **Confirm**.
4. Put the NFC detection area of the phone close to the NFC antenna of the device.

If the device is successfully reset, the following page is displayed.



Reset successfully!



Note:

If unable to read or write devices normally using the ToolBox, perform a [hardware reset](#).

Chapter 6. Uplink Packets and Downlink Commands

This chapter describes that uplink data packet and downlink commands supported by the device.

All messages follow the following format (HEX), the Parameter/Data field must follow **little-endian** byte order:

Command ID	Parameter/Data	...
N Bytes	0-N Byte	...

For decoder and encoder examples, please find files on <https://github.com/Milesight-IoT/SensorDecoders>. For details of uplink reports and downlink commands please refer to the sections below.

Uplink Packets

This section describes the uplink packets reported by the device.

Basic Information Packet

After joining the network, the device reports a packet containing the basic device information, totaling four reports.

Packet description:

Item	Byte	Command	Description
TSL Version	1+2	df	Example: 01 02 = V1.2
Device Request	2	ee	Report only after reset
Serial Number	1+8	db	16 digits
Device Version	1+8	da	Hardware version (2B) + Software version (2B) + 00000000
OEM ID	1+2	d9	4 digits
Device Status	1+1	c8	00: Off, 01: On
Work Mode	2+1	cf00	00: Class A, 01: Class B, 02: Class C, 03: Class C to B

Example:

df0100 ee db6527f41809380000 da0100010100000000 d90000 c801 cf0001	
Command	Value
df	TSL Version: 01 00 => V1.0
ee	Reset
db	SN: 6527f41809380000
da	Hardware Version: 0100 => V1.0 Software Version: 0101=> V1.1
d9	OEM ID: 0000
c8	01: Device is on
cf00	01: Class B

Periodic Data Packet

Normally Periodic Data Packet

The device reports a data packet at a configured reporting interval. In addition, the device supports a [change report command](#) to enable sending a periodic report when the target temperature or valve opening changes.

Packet description:

Item	Byte	Command	Description
Non-heating Periodic Report	2+2	0e00	Byte 1: Target Valve Opening, UINT8, Unit: % Byte 2: Energy Level, UINT8, Unit: %
Automatic Temperature Control Report	2+6	0e01	Byte 1-2: Ambient Temperature, INT16/100, Unit: °C Byte 3: Current Valve Opening, UINT8, Unit: % Byte 4-5: Target Temperature, INT16/100, Unit: °C Byte 6: Energy Level, UINT8, Unit: %
Valve Opening Control Report	2+5	0e02	Byte 1-2: Ambient Temperature, INT16/100, Unit: °C Byte 3: Current Valve Opening, UINT8, Unit: % Byte 4: Target Valve Opening, UINT8, Unit: % Byte 5: Energy Level, UINT8, Unit: %

Item	Byte	Command	Description
Integrated Control Report	2+7	0e03	Byte 1-2: Ambient Temperature, INT16/100, Unit: °C Byte 3: Current Valve Opening, UINT8, Unit: % Byte 4-5: Target Temperature, INT16/100, Unit: °C Byte 6: Target Valve Opening, UINT8, Unit: % Byte 7: Energy Level, UINT8, Unit: %

Example:

1. Periodic packet for non-heating period

0e006464	
Command	Value
0e00	Target Valve Opening: 64=>100% Energy Level: 64=>100%

2. Periodic packet for Automatic Temperature Control mode

0e016309006c0764	
Command	Value
0e01	Ambient Temperature: 63 09 =>09 63=2403/100=24.03 °C Current Valve Opening: 00=> 0% Target Temperature: 6c 07 => 07 6c = 1900/100=19 °C Energy Level: 64=>100%

3. Periodic packet for Valve Opening Control mode

0e026309003264	
Command	Value
0e02	Ambient Temperature: 63 09 =>09 63=2403/100=24.03 °C Current Valve Opening: 00=> 0% Target Valve Opening: 32=>50% Energy Level: 64=>100%

4. Periodic packet for Integrated Control mode

0e036309006c073264	
Command	Value
0e03	Ambient Temperature: 63 09 =>09 63=2403/100=24.03 °C Current Valve Opening: 00=> 0% Target Temperature: 6c 07 => 07 6c = 1900/100=19 °C Target Valve Opening: 32=>50% Energy Level: 64=>100%

Historical Periodic Data Report

When [data retransmission](#) is triggered, the device will report a historical periodic report at data retransmission interval.

Packet description:

Command	Report Mode	Timestamp	Historical Data
ed	01	UINT32, Unit: s	Command + Data, see Data description

Data description:

Item	Byte	Command	Description
Energy Level	1+1	00	UINT8, Unit: %
Ambient Temperature	1+2	01	INT16/100, Unit: °C 8000=Disabled, 8001=Collection Failure, 8002=Over-range, 8003=Under-range
Current Valve Opening	1+1	04	UINT8, Unit: %
Target Temperature	1+2	06	INT16/100, Unit: °C
Target Valve Opening	1+1	07	UINT8, Unit: %

Example:

ed01fd605b69019b0a04000064063a07				
Command	Report Mode	Timestamp	Com- mand	Value
ed	01	fd 60 5b 69 => 695b60fd =1767596285s	01	Ambient Temperature: 9b 0a=>0a 9b=2715/100=27.15°C
			04	Current valve opening: 00>0%
			00	Energy Level: 64=>100%
			06	Target Temperature: 3a 07 => 07 3a = 1850/100=18.5 °C

Alarm Report

The device reports the following types of alarm packets.

Packet description:

Item	Byte	Com- mand	Description
Low Energy Alarm	1+1	08	UINT8, Unit: %
Temperature Alarm	1+3	09	Byte 1: 10=Below dismiss, 11=Below threshold, 12=Above dismiss, 13=Above threshold Byte 2-3: Ambient Temperature, INT16/10, Unit: °C
Freeze Protection Alarm	1+4	0a	Byte 1: 20=Alarm release, 21=Alarm Byte 2-3: Ambient Temperature, INT16/10, Unit: °C Byte 4: Current Valve Opening, UINT8, Unit: %
Force Heating Alarm	1+5	0b	Byte 1: 20=Exit force heating, 21=Start force heating Byte 2-3: Ambient Temperature, INT16/10, Unit: °C Byte 4: Current Valve Opening, UINT8, Unit: % Byte 5: Energy Level, UINT8, Unit: %
Open Window Alarm	1+4	0d	Byte 1: 20=Alarm release, 21=Alarm Byte 2: 00=Window close, 01=Window open Byte 3-4: Ambient Temperature, INT16/10, Unit: °C

Examples:

1. Low energy alarm: Report once per minute when the energy level falls below 15%, for a total of three reports.

080d	
Command	Value
08	Energy Level: 0d=>14%

2. Temperature alarm: Report once when the ambient temperature reaches the threshold.

09139e0a	
Command	Value
09	13=Above threshold Ambient temperature: 9e 0a => 0a 9e=2718/100=27.18°C

3. Force heating exit: Report when the device stops force heating.

0b209b0a0064	
Command	Value
0b	20=Exit force heating Ambient temperature: 9b 0a => 0a 9b=2715/100=27.15°C Current valve opening: 00=>0% Energy Level: 64=>100%

Motor Stroke Calibration Packet

The device reports a data packet after a motor stroke calibration.

Packet description:

Item	Byte	Command	Description
Calibration Result	1+1	05	00=Not calibrated, 01=Success, 02=Over-range, 03=Temperature control disable, 04=Uninstall

Item	Byte	Command	Description
Total Motor Stroke	1+2	02	UINT16
Motor Position	1+2	03	UINT16

Example:

1. Calibration success

0501024009	
Command	Value
05	01=Success
02	Total motor stroke: 40 09=> 09 40=2368

2. Calibration failure

0502	
Command	Value
05	02=Over-range

Downlink Commands

Downlink commands can be used for remote control of device through a network server. The downlink port (application port) is 85 by default and can be configured through ToolBox.

If the device receives a downlink command requiring confirmation, it will send a reply packet in the following format:

Command (1B)	Result & Length (1B)	Command ID (1-N Byte)	...
ef	Bit 7-4: result code, 0=success, 5=parameter error, 7=execute error, 10=association error Bit 3-0: command length	Same as downlink command	...

For details of downlink commands please refer to the sections below.

Commands for General Setting

The device supports multiple commands for general settings.

Command description:

Item	Byte	Com- mand	Description
Temperature Unit	1+1	60	00=°C, 01=°F
Ambient Temperature Source = Internal NTC	2+0	6100	-
Ambient Temperature Source = USB-C NTC	2+3	6101	Byte 1-2: Offline timeout, UINT16, Unit: min, Range: 1-1440, Default: 30 Byte 3: Offline mode, 00=Keep current status, 01=Close valve, 02=Switch to internal NTC (Default)
Ambient Temperature Source = LoRa Downlink	2+3	6102	Byte 1-2: Offline timeout, UINT16, Unit: min, Range: 1-1440, Default: 30 Byte 3: Offline mode, 00=Keep current status, 01=Close valve, 02=Switch to internal NTC (Default)
Ambient Temperature	1+2	5b	INT16/100, Unit: °C, Range: -20-60 Only work when ambient temperature source is LoRa Downlink
Ambient Temperature Display	1+1	62	00=Disable, 01=Enable
Heating Date	2+4	6300	Byte 1: Start month, range: 1-12 Byte 2: Start day, range: 1-31 Byte 3: End month, range: 1-12 Byte 4: End day, range: 1-31
Heating Period Reporting Interval	2+3	6301	Byte 1: 01 Byte 2-3: UINT16, Unit: min, Range: 5-1440, Default: 10
Non-heating Period Reporting Interval	2+3	6302	Byte 1: 01

Item	Byte	Command	Description				
			Byte 2-3: UINT16, Unit: min, Range: 5-1440, Default: 1440				
Non-heating Period Valve Status	2+1	6303	00=Fully close, 01=Fully open				
Child Locks	1+2	6a	Byte 1: 00=Disable, 01=Enable Byte 2: 01=System On/Off, 02=Temperature +/-, 03=All				
Time Zone	1+2	c7	INT16/60				
Daylight Saving Time	1+10	c6	<p>Byte 1: 00=Disable, 01=Enable</p> <p>Byte 2: DST bias, unit: min, range: 1-120</p> <p>Byte 3-6: Start time, Month (1B)+Week&Day (1B) + Minute Time (2B)</p> <p>Byte 7-10: End time, Month (1B)+Week&Day (1B) + Minute Time (2B)</p> <p>Week&Day:</p> <table border="1" data-bbox="743 1094 1421 1224"> <thead> <tr> <th>Bit7-4</th> <th>Bit3-0</th> </tr> </thead> <tbody> <tr> <td>Week number, range: 1-5</td> <td>Weekday, range: 1-7</td> </tr> </tbody> </table>	Bit7-4	Bit3-0	Week number, range: 1-5	Weekday, range: 1-7
Bit7-4	Bit3-0						
Week number, range: 1-5	Weekday, range: 1-7						
Data Storage & Retransmission	1+2	c5	Byte 1: 00=Data storage, 01=Data retransmission Byte 2: 00=Disable, 01=Enable				
Data Retransmission Interval	1+3	c5	Byte 1: 02 Byte 2-3: UINT16, Unit:s, Range: 30-1200 s, Default: 600s				
Reboot	1	be	-				
Enquiry Periodic Report	1	b9	-				
Sync Time from LNS	1	b8	-				
Rejoin the Network	1	b6	-				
Clear History Data	1	bd	-				

Example:

1. Select ambient temperature source as USB-C NTC and configure the related parameters.

6101140000	
Command	Value
6101	Offline timeout: 14 00=>00 14=20 minutes Offline mode: 00=Keep current status

2. Reboot the device.

be

3. Set the heating period reporting interval as 20 minutes.

6301011400	
Command	Value
6301	14 00=>00 14=20 minutes

4. Set the time zone as UTC-4.

c710ff	
Command	Value
c7	10 ff => ff 10 = -240/60=-4

5. Set DST time: start time is last Sunday 1:00 of March, end time is last Sunday 1:00 of October, and bias is 1h (60 minutes).

c6013c03573c000a573c00	
Command	Value
c6	01=Enable DST bias: 3c=>60 mins Start time: 03=>March, 57=>last (5) Sunday(7), 3c 00 =>00 3c=60 minutes =1:00 End time: 0a=>10=October, 57=>last (5) Sunday(7), 3c 00 =>00 3c=60 minutes =1:00

Related information[Configure General Parameters](#)

Commands for Temperature Control Settings

The device supports multiple commands for temperature control settings.

Command description:

Item	Byte	Command	Description
Temperature Control	2+1	6500	00=Disable, 01=Enable
Target Temperature Resolution	2+1	6501	00=0.5, 01=1
Min. Target Temperature Regulation Range	2+2	6504	INT16/100, Unit: °C, Range: 5-35
Max. Target Temperature Regulation Range	2+2	6505	INT16/100, Unit: °C, Range: 5-35
Automatic Temperature Control	3+2	650600	Target temperature: INT16/100, Unit: °C, Range: 5-35
Valve Opening Control	3+1	650601	Valve opening, UINT8, Unit: %
Integrated Control	3+2	650602	Target temperature: INT16/100, Unit: °C, Range: 5-35
Target Temperature	1+2	5a	INT16/100, Unit: °C, Range: 5-35 Only works under Automatic Temperature Control or Integrated Control mode
Valve Opening	1+1	59	UINT8, Unit: % Only works under Valve Opening Control or Integrated Control mode
Target Temperature/Valve Opening Change Report	1+1	6f	00=Disable, 01=Enable

Item	Byte	Command	Description
Open Window Detection	1+6	66	Byte 1: 00=Disable, 01=Enable Byte 2-3: Cooling rate, INT16/100, Unit: °C/min, Range: 2-10 Byte 4: Valve status, 00=Remains unchanged, 01=Close valve Byte 5-6: Stop temperature control time, UINT16, Unit: min, Range: 1-1440
Open Window Alarm	1+1	5d	00=Release, 01=Trigger
Freeze Protection	1+3	68	Byte 1: 00=Disable, 01=Enable Byte 2-3: Freeze protection temperature, INT16/100, Unit: °C, Range: 1-5
Force Heating	1+1	69	00=Disable, 01=Enable

Example:

1. Select temperature control mode as Automatic Temperature Control and configure the related parameters.

650600d007	
Command	Value
650600	Target temperature: d0 07=>07 d0=2000/100=20°C

2. Adjust target temperature to 20°C.

5ad007	
Command	Value
5a	d0 07=>07 d0=2000/100=20°C

Related information

[Configure Temperature Control Parameters](#)

Commands for Calibration Settings

The device supports multiple commands for calibration setting.

Command description:

Item	Byte	Command	Description
Motor Stroke Calibration	1	58	-
Query Motor Stroke	1	57	-
Effective Stroke	1+1	6b	UINT8, Unit: %
Temperature Calibration	1+3	6c	Byte 1: 00=Disable, 01=Enable Byte 2-3: Calibration value, INT16/100, range: -60-60, Unit: °C

Example:

1. Calibrate stroke once.

58

2. Query motor stroke status.

57

Reply:

024009031605	
Command	Value
02	Total motor stroke: 40 09=> 09 40=2368
03	Motor position: 16 05 => 05 16= 1302

3. Enable temperature calibration and set the calibration value.

6c01e2ff	
Command	Value
6c	01=Enable Calibration value: e2 ff=> ff e2 $=-30/100=-0.3^{\circ}\text{C}$

Related information[Configure Calibration Parameters](#)[Motor Stroke Calibration Packet](#)

Command for Threshold Setting

The device supports a command for threshold setting.

Command description:

Item	Byte	Com- mand	Description
Temperature Threshold	1+6	6d	Byte 1: 00=Disable, 01=Enable Byte 2: 01=Below, 02=Above, 04=Within Byte 3-4: Min. threshold, INT16/100, range: -20-60, Unit: $^{\circ}\text{C}$ Byte 5-6: Max. threshold, INT16/100, range: -20-60, Unit: $^{\circ}\text{C}$

Example:

Enable the temperature threshold alarm and set the alarm threshold as over 25°C .

6d01020000c409	
Command	Value
6d	01=Enable, 02=Above Max. threshold: c4 09 => 09 c4 => $2500/100 = 25^{\circ}\text{C}$

Related information[Configure Temperature Threshold Parameters](#)

Commands for Schedule Settings

The device supports multiple commands for schedule settings.

Command description:

Item	Byte	Command	Description												
Schedule Event	3+1	6e + Event ID (1B, 0-15) +00	00=Disable, 01=Enable												
Schedule Time	3+2	6e + Event ID (1B, 0-15) +01	UINT16, Range: 0-1439, Unit: min												
Schedule Repeat Day	3+1	6e + Event ID (1B, 0-15) +02	Per bit 0=Disable, 1=Enable <table border="1" style="margin-left: auto; margin-right: auto;"> <thead> <tr> <th>Bit</th> <th>7</th> <th>6</th> <th>...</th> <th>1</th> <th>0</th> </tr> </thead> <tbody> <tr> <td></td> <td>0</td> <td>Sat.</td> <td>...</td> <td>Mon.</td> <td>Sun.</td> </tr> </tbody> </table>	Bit	7	6	...	1	0		0	Sat.	...	Mon.	Sun.
Bit	7	6	...	1	0										
	0	Sat.	...	Mon.	Sun.										
Temperature Control Mode	3+1	6e + Event ID (1B, 0-15) +03	00=Automatic Temperature Control, 01=Valve Opening Control, 02=Integrated Control												
Target Temperature	3+2	6e + Event ID (1B, 0-15) +04	UINT16/100, Unit: °C, Range: 5-35												
Valve Opening	3+1	6e + Event ID (1B, 0-15) +05	UINT8, Unit: %												
Reporting Interval	3+2	6e + Event ID (1B, 0-15) +09	UINT16, Unit: min, Range: 5-1440												
Delete Schedule Event	1+1	5e	Event ID, range: 0-15, 0xff=Delete all												

Example:

Add a schedule event 1.

6e0000016e000158026e0002506e0003026e0004d0076e00090500	
Command	Value
6e0000	01=Enable
6e0001	Schedule time: 58 02=> 02 58= 600 minutes = 10:00

6e0000016e000158026e0002506e0003026e0004d0076e00090500	
Command	Value
6e0002	Repeat day: 50=>0101 0000 =Thursday and Saturday enable
6e0003	Temperature control mode: 02=Integrated Control
6e0004	Target temperature: d0 07=>07 d0=2000/100=20°C
6e0009	Reporting Interval: 05 00=>00 05=5 minutes

Related information

[Configure Schedule Parameters](#)

Commands for Historical Data Query

The device can query historical data for a specified time point or range through downlink commands. The specified time point can use [Unix Timestamp Converter](#) to calculate. The prerequisites are that the device time is correct and the **data storage function** is enabled. The device uploads a maximum of 300 data records per range query.

When querying data for a specific time point, the device uploads the record closest to the requested time within the current reporting interval. For example, with a 10-minute reporting interval, a query for 17:00 will return the exact record if it exists. Otherwise, the device searches for data within a tolerance of ± 10 minutes (16:50 to 17:10) and uploads the record closest to 17:00.

Command description:

Item	Byte	Command	Description
Query data for a specified time point	1+4	ba	Unix timestamp, UINT32, Unit: s
Query data for a specified time range	1+8	bb	Start Unix Timestamp (4B) + End Unix Timestamp (4B), UINT32, Unit: s
Stop data query report	1	bc	-
Query report interval	1+3	c5	Byte 1: 03 Byte 2-3: UINT16, Unit:s, Range: 30-1200 s, Default: 60s

Reply format:

Command	Report Mode	Timestamp	Historical Data
ed	01	UINT32, Unit: s	Command + Data, see Data description

Data description:

Item	Byte	Command	Description
Energy Level	1+1	00	UINT8, Unit: %
Ambient Temperature	1+2	01	INT16/100, Unit: °C 8000=Disabled, 8001=Collection Failure, 8002=Over-range, 8003=Under-range
Current Valve Opening	1+1	04	UINT8, Unit: %
Target Temperature	1+2	06	INT16/100, Unit: °C
Target Valve Opening	1+1	07	UINT8, Unit: %

Example:

Enquire the historical data in a time range.

bb44605b699c625b69	
Command	Value
bb	Start time: 44 60 5b 69 => 69 5b 60 44 = 1767596100s End time: 9c 62 5b 69 => 69 5b 62 9c = 1767596700s

Reply:

ed01fd605b69019b0a04000064063a07				
Command	Report Mode	Timestamp	Com- mand	Value
ed	01	fd 60 5b 69 => 695b60fd =1767596285s	01	Ambient Temperature: 9b 0a=>0a 9b=2715/100=27.15°C
			04	Current valve opening: 00>0%

ed01fd605b69019b0a04000064063a07				
Command	Report Mode	Timestamp	Com- mand	Value
			00	Energy Level: 64=>100%
			06	Target Temperature: 3a 07 => 07 3a = 1850/100=18.5 °C

Related information

[Configure Data Storage & Retransmission](#)

Chapter 7. Services

Milesight provides customers with timely and comprehensive technical support services. End-users can contact their local dealer to obtain technical support. Distributors and resellers can contact Milesight directly for technical support.

Technical Support Mailbox: iot.support@milesight.com

Online Support Portal: <https://support.milesight-iot.com>

Resource Download Center: <https://www.milesight.com/iot/resources/download-center/>

MILESIGHT CHINA

TEL: +86-592-5085280

FAX: +86-592-5023065

Add: Building C09, Software Park Phase III, Xiamen 361024, Fujian, China