

MClimate HT Sensor LoRaWAN®

User manual

**Scan the QR Code
to access MClimate HT
Sensor LoRaWAN®
extended
documentation**



mclimate.eu/lorawan-resources

**Need
some help?**

For more product information
and issues related to it, visit:
mclimate.eu/lorawan-resources

or write us to:
lorawan-support@mclimate.eu

 **00359 800 3 1010**
Monday-Friday 09:00 - 18:00

 **Sofia, Bulgaria**
Sofia Tech Park,
labs building, floor 1

Bulgarian

За да разберете как се инсталира MClimate HT Sensor LoRaWAN®, сканирайте QR кода или посетете линка до него.

Italian

Per installare MClimate HT Sensor LoRaWAN® scannerizzare il codice QR oppure aprire il link al suo lato.

Swedish

För att ta reda på hur du installerar MClimate HT Sensor LoRaWAN®, skanna QR-koden eller besök länken bredvid den.

German

Um herauszufinden, wie man MClimate HT Sensor LoRaWAN® installiert, scannen Sie den QR-Code oder besuchen Sie den Link daneben.

Dutch

Om te weten te komen hoe u MClimate HT Sensor LoRaWAN® installeert, scan de QR-code of bezoek de link ernaast.

Czech

Chcete-li zjistit, jak nainstalovat MClimate HT Sensor LoRaWAN®, prohlédněte si kód QR nebo navštivte odkaz vedle něj.

Polish

Aby dowiedzieć się, jak zainstalować MClimate HT Sensor LoRaWAN®, zeskanuj kod QR lub odwiedź link obok niego.

Finnish

Tutustu MClimate HT Sensor LoRaWAN®-laitteen asentamiseen, skanna QR-koodi tai vierailla sen vieressä olevassa linkissä.

French

Pour savoir comment installer MClimate HT Sensor LoRaWAN®, scannez le code QR ou visitez le lien à côté de celui-ci.

Spanish

Para saber cómo instalar MClimate HT Sensor LoRaWAN®, escanee el código QR o visite el enlace al lado.

Table of content

01	What is in the box?	2
02	Technical details, Safety instructions, Legal Notices & Compatibility	3
03	Device Parts, Mechanical dimensions	4
04	LED, Buttons and behaviour	5-6
05	Commissioning	7-8
06	Installation	9
07	Installation of external temperature sensor (NTC)	10

What's inside the box?

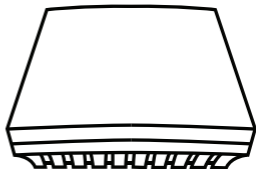

MClimate HT Sensor
LoRaWAN®

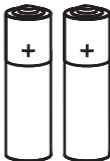

2xAA Batteries
Energizer Lithium Ultimate L91

Technical specifications

Description: LoRaWAN temperature and humidity sensor

Model: MC-LW-HT-01-BI

Dimensions: 80 x 80 x 19mm

Weight: 60gr

Frequency range: 863÷870MHz

LoRaWAN® Device type: Class A End-device

Power supply: 2xAA batteries 1,5VDC

Sensors: built-in temperature and humidity sensor

Work temperature: 0°C to +50°C

Material: ABS

Environmental conditions, in which the device is intended to operate:

- Indoor using;
- for altitude up to 2000m;
- for an ambient temperature: 0°C to +60°C;
- for maximum relative humidity of 80% for temperature up to 31°C, decreasing linearly to 25% relative humidity at temperature 50°C;
- for environment with a degree of contamination 2 (PD2).

Storage and transportation conditions:

- for an ambient temperature :-40°C to +85°C;
- for relative humidity 5% to 90% without condensation

Manufacturer

MClimate Jsc, 1784 Sofia, Sofia Tech Park, Labs Building, 111J Tsarigradsko Shose

Compliance with the WEEE Directive

The appliance marked with this symbol should not be disposed of with other household waste. It must be handed over to the relevant collection point for the recycling of electrical and electronic equipment.

▲ Safety Instructions

Please read the safety instructions before installing the device! Failure to follow the recommended instructions in this manual may be dangerous or in violation of the law. The manufacturer MClimate Jsc., is not responsible for any loss or damage caused by failure to follow the instructions in the operating manual.

Legal Notices

All information, including but not limited to, features, functionality, and / or other product specifications are subject to change without notice. MClimate retains all rights to review or update its products, software or documentation without being required to notify any natural or legal person.

The MClimate and MClimate logo are trademarks of MClimate Jsc. All other brands and product names mentioned herein are trademarks of their respective owners.

EU Declaration of Conformity

This device complies with the essential requirements and other applicable provisions of the following EU directives:

2014/53/EC, EN 50491-3:2009

EEU 300 220-1 V3.1.1:2017

EN 60950-1:2006+A11:2009 +A1:2010+A12:2011+

A2:2013 + AC:2015

EEU 300 220-2 V3.1.1:2017, EN 301 489-1

Compatibility

In order to operate MClimate HT Sensor

LoRaWAN®, you will need:

LoRaWAN® network

Battery (2xAA battery 1,5VDC)

Device operating voltage: 2.7 - 3.6VDC



Device parts

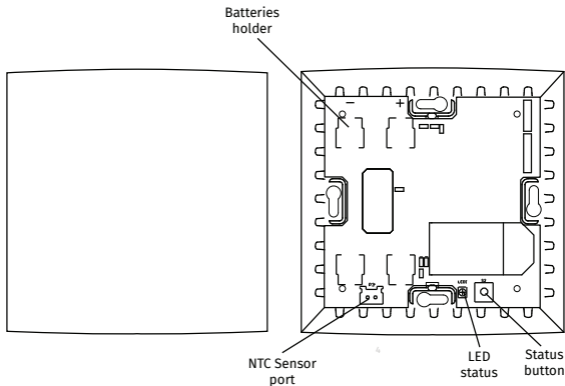

Assembled MClimate HT Sensor
LoRaWAN®, top view

Disassembled MClimate HT Sensor
LoRaWAN®, top view

LED, Buttons and behaviour

When you press the button, the device indicates the current network status:

1. Device has successfully connected to the network (has received Join Accept):
 - a. The LED will show constant light for about 1 second to indicate it has successfully connected to a network.
2. Device is not yet connected to a network:
 - a. The LED will blink a few times at regular intervals.



LED, Buttons and behaviour

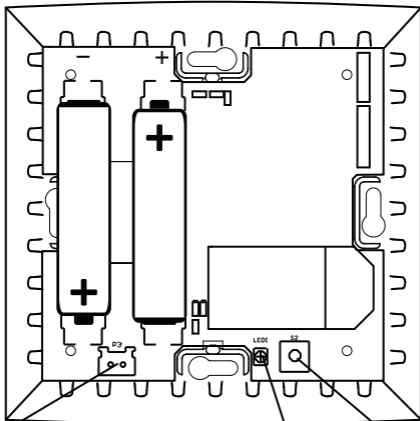

Connector for optional external
10K NTC temperature sensor.

LED status Status button



Warning: The button has no other function than to check the connection status. Long-pressing it will NOT reset the device.

Commissioning

- 1 Open your LoRaWAN® Network provider access panel and add the device using the supplied Serial Number, DevEUI, AppEUI (JoinEUI) and AppKey.

Device ID: 9X7	U2TH5
DevEUI: 70B3D25D	030000E1
AppEUI: 70B3D25D	00300000
AppKey: A0658DFAE7213	5AF0N8M8CT1

Register



The data is example.
Do not use.

- 2 Continue the Installation with the instructions of your LoRaWAN® Network provider.

MClimate_LoRaWAN_51177

Serial Number	DevEui	AppEui	AppKey
GV19E123456789	70E123456789ABC	70B123456789ABC	5fc3123456789ABCDEF123456789



You can get DevEUI, AppEUI (JoinEUI) & AppKey information from the LoRaWAN® credentials .csv file we sent you with the fulfillment confirmation.

- 3** After pulling away the protective film from the batteries, the device will automatically connect to the network. In order to see whether the device has connected to the network, please check **LED, Buttons and behaviour**.

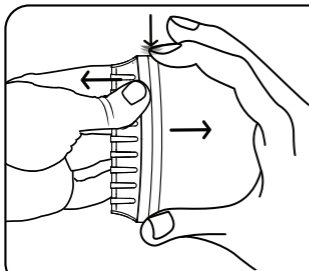
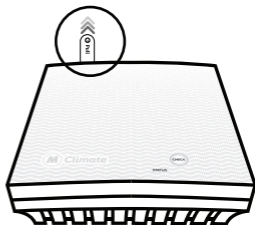

In order to remove the frontal plastic cover, apply pressure on the top and bottom of the front plate with one hand and hold the bottom plate with the other, gently lift one of the sides.

Installation

We recommend installing the device in an open environment (e.g. not in a recess) at 1.5m height. Do not install the device near air vents as it will negatively impact the measurements. Avoid large metal parts as it will worsen the RF performance. Use double-sided tape to attach it or remove the frontal plastic cover and use screws to attach it in a more permanent manner.

We recommend installing the device so that the QR code with the serial number stays on the bottom-right side of the device in order to ensure good measurements.

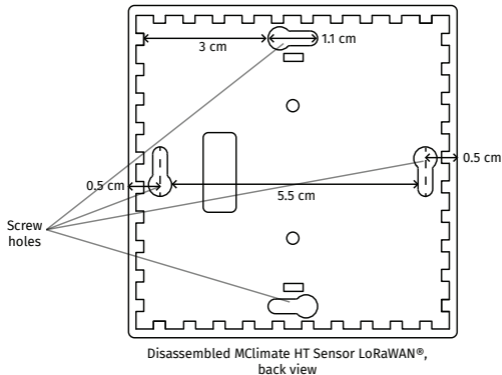

Installation of external temperature sensor (NTC)

MClimate HT measures ambient temperature and relative humidity using a digital temperature sensor. The device also supports installing an additional temperature sensor (NTC) in cases where you want to monitor e.g. pipe surface temperature.

In case you have purchased an external temperature sensor (NTC), connect it to the connector as shown in the picture below. You will automatically start receiving the temperature reading as of the next uplink.

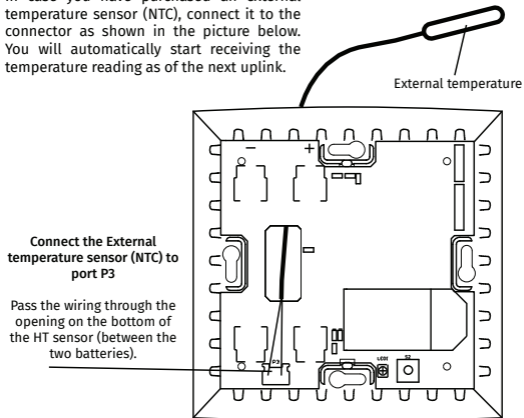

Disassembled HT Sensor, top



We
make any
building
smart.

www.mclimate.eu

Designed & Manufactured by MClimate in Europe.